

ANNEXE D

Rapport de l'étude géotechnique

Saint-Rémi, June 11, 2010

O/F : G1-09-1532

Mr. John Olson
TRANSALTA WIND CORPORATE OFFICE
TRANSALTA CORPORATION
110 12th Avenue S.W.
Calgary AB T2P 2M1

Object: **Geotechnical study – Construction of wind energy converters**
Terrains located in the vicinity of the town of Saint-Valentin, Quebec.

Dear Sir,

Following your agreement to our proposal PG1-09-1529-4 dated on April 29, 2010, we herewith transmit to you the geotechnical report of study carried out by our firm for the project quoted in title.

We hope that it will be to your full satisfaction and we thank you for allowing us to take part in the realization of your project.

Do not hesitate to contact us for all additional questions concerning the present study.

Sincerely yours,

Groupe ABS inc.

Ursula Maselbas, Eng., M.A.Sc.
Team leader, geotechnical

Enc. Reports (1 original and 1 copy)

**GEOTECHNICAL STUDY
CONSTRUCTION OF WIND
ENERGY CONVERTERS**

Terrains located in the vicinity of the town
of St-Valentin in Quebec

O/F : G1-09-1532
June 11, 2010

Mr. John Olson
TRANSALTA WIND CORPORATE OFFICE
TRANSALTA CORPORATION
110 12th Avenue S.W.
Calgary AB T2P 2M1

Prepared by:

Ibrahim Ja'far, Eng., M.Eng.

Verified by:

Ursula Maselbas, Eng., M.A.Sc.

Distribution :
TransAlta Corporation (1 original & 1 copy)
Groupe ABS inc. (1 copy)

*The attached information refers only to the present document.
It should not be reproduced, if not entirety, without the authorization of Groupe ABS inc.*

TABLE OF CONTENTS

1. INTRODUCTION 1

2. SCOPE OF THE INVESTIGATION 1

3. FIELD EXPLORATION PROCEDURES 2

 3.1 FIELDWORK 2

 3.1.1. Boreholes 2

 3.1.2. Geophysical exploration 2

 3.2 FIELD SURVEY 2

 3.3 LABORATORY TESTING 4

4. SOIL PROFILE AND PROPERTIES 4

 4.1 GROUP M (SITES 4, 6, 11, 12, 14) 5

 4.2 GROUP M (SITES 8, 13) 6

 4.3 GROUP O (SITES 25, 27, 28, 28A, 31, 31A) 6

 4.4 GROUP P (SITES 5, 7, 9, 10, 16, 17, 18, 20, 21, 22, 23, 37) 7

 4.5 GROUP Q (SITES 26, 29, 30, 32, 34, 35) 7

5. GROUNDWATER OBSERVATION 7

6. CONCLUSIONS AND RECOMMANDATIONS 9

 6.1 GENERAL COMMENTS 9

 6.2 FOUNDATION DESIGN 9

 6.2.1 Shallow foundation 10

 6.2.2 Deep foundation 11

 6.3 SOILS GEOTECHNICAL PROPERTIES 12

 6.4 TEMPORARY EXCAVATION AND DRAINAGE 14

 6.5 SITE CLASSIFICATION FOR SEISMIC SITE RESPONSE 15

7. LIMITATIONS OF THE STUDY 15

LISTE OF APPENDICES

Appendix A: Google satellite photos

Appendix B: Key-Plan

Appendix C: Borehole logs

Appendix D: Laboratory tests

Appendix E: geophysical investigation report

Appendix F: rock samples photography

Appendix G: Miscellaneous documents

1. INTRODUCTION

GROUPE ABS INC. services were retained by the company *TRANSALTA CORPORATION* (hereinafter called *client*) to conduct a geotechnical subsoil investigation for 31 proposed wind energy converters to be located in the vicinity of the town of Saint-Valentin, about 50 km south of Montreal in Quebec.

This geotechnical study was performed according to our professional proposal dated April 29, 2010 (PG1-09-1529-04).

The subject properties are located within a 5 km radius from the town of St-Valentin. They are located in an agricultural land with flat topography. Satellite photos showing the configuration of each site are attached in appendix A.

Throughout this report, sites are classified in five (5) groups according to their geographical location (refer to Key-Plan in appendix B of this report):

- Group M includes sites 4, 6, 11, 12 and 14 (5 sites)
- Group N includes sites 8 and 13 (2 sites)
- Group O includes sites 25, 27, 28, 28A, 31 and 31A (6 sites)
- Group P includes sites 5, 7, 9, 10, 16, 17, 18, 20, 21, 22, 23 and 37 (12 sites)
- Group Q includes sites 26, 29, 30, 32, 34 and 35 (6 sites)

A Google satellite photos are enclosed in appendix A. The drilling borehole locations are shown in the plan enclosed in appendix B, the borehole logs are attached in appendix C, the geophysical investigation report is attached in appendix D and the results of the laboratory tests are included in appendix E. Photography of rock cores is presented in appendix F. Finally, miscellaneous documents are attached in appendix G.

2. SCOPE OF THE INVESTIGATION

This geotechnical investigation is primarily aimed at determining the profile and the quality of the subsoil strata as well as the ground water condition by means of boreholes and geophysical methods. The methodology used on-site and in laboratory has allowed the verification of subsoil conditions for the subject sites and the formulation of general recommendations for the project, namely:

- The nature of subsurface materials and their stratigraphic sequence;
- The groundwater level;
- The competent soil/rock strata to receive the anticipated loads;
- Bearing capacity of shallow and deep foundation;
- Soils geotechnical properties;
- Slope stability for temporary excavation;
- General recommendations.

3. FIELD EXPLORATION PROCEDURES

3.1 *Fieldwork*

As per our professional proposal, the subsoil investigation included two parts: the first part, which is the main one, consisted of drilling boreholes from which disturbed soil and rock samples were retrieved following standard procedures in conjunction with the American Society for Testing and Materials standards (ASTM). The second part of the investigation, the complementary part, consisted in carrying out geophysical surveying for the subject sites.

3.1.1. *Boreholes*

The first part of the investigation program consisted of drilling a total of thirty-one (31) boreholes (one borehole for each site) advanced to a competent soil or the bedrock. The boreholes are named after their respective site numbers (ex. Borehole 10BH-04 represents site 4 and so forth). The field exploration program was carried out between March 08, 2010 and April 26, 2010 under the constant supervision of our geotechnical personnel and in the presence of the client's representatives.

The boreholes were drilled by means of a track-mounted rotary drill rig, property of the subcontractor, *Explora-Sol Inc.* Soil samples were recovered using a 50 mm OD (outside diameter) split-spoon sampler in conjunction with ASTM D-1586 standard penetration test. This test consists of driving the standard sampler into the soil using a 63.5 kg hammer dropped from a height of 76 cm. The number of blows for each 30 centimetres of penetration named "SPT - N Value" can be correlated to the relative density of the sampled soil.

In the majority of boreholes, the bedrock was cored using a NQ tube core barrel. The length of cored rocks is ± 3 m. In addition, in-situ vane shear test was conducted where clayey soil was encountered.

An observation well was installed on each borehole in order to monitor the groundwater conditions.

3.1.2. *Geophysical exploration*

The geophysical exploration method used in this project is a seismic method called the Multi-Channel Analysis of surface Waves (MASW). The seismic exploration was carried out by our subcontractor *Geophysics GPR International inc (hereinafter called GPR)*. Site works were conducted between March 15 and 27, 2010 and on June 2nd, 2010. A detailed description of this method is included in section 3 of the report entitled " Shear wave velocity sounding results – Wind energy converters project, Saint-Valentin, Quebec" produced by GPR (report no. M09789 dated June 2010 – copy attached in appendix E of this report).

3.2 *field survey*

The locations of boreholes were determined by the client. During the field investigation work, the borehole locations were identified by a pre-installed wooden stick on which the name of the site was written. All borehole locations were confirmed by the client's representative before the undertaking of the drilling works. The geodesic coordination of boreholes were furnished by the client and they are presented in table 1.

Table 1 : geodesic coordinates

Borehole	Longitude X	Latitude Y	Elevation (m)
Group M			
10BH-04	316203	4994292	41.00
10BH-06	316202	4994943	42.00
10BH-11	316592	4994528	43.00
10BH-12	316596	4994055	42.13
10BH-14	316620	4994936	44.00
Group N			
10BH-08	316248	4998369	51.00
10BH-13	316618	4998175	47.92
Group O			
10BH-25	319312	4997246	38.00
10BH-27	319664	4996999	35.00
10BH-28	319665	4997492	35.00
10BH-28A	319414	4997499	-
10BH-31	320095	4997479	34.00
10BH-31A	319926	4997484	-
Group P			
10BH-05	316239	5001777	50.00
10BH-07	316244	5002438	49.00
10BH-09	316478	5001418	50.00
10BH-10	316497	5002120	
10BH-16	316876	5001955	51.00
10BH-17	317102	5001353	50.00
10BH-18	317273	5002650	50.00
10BH-20	317482	5002277	49.00
10BH-21	318008	5002258	48.00
10BH-22	318187	5001293	46.00
10BH-23	318195	5001745	47.00
10BH-37	318483	5001515	-
Group Q			
10BH-26	319774	5001316	40.84
10BH-29	319828	5002096	45.00
10BH-30	320091	5001646	41.00
10BH-32	320241	5002214	43.00
10BH-34	319415	5002922	-
10BH-35	319169	5002673	-

3.3 Laboratory testing

All samples collected during the fieldwork were transported to our laboratory for the purpose of analysis, identification and classification. They all made the subject of a careful visual inspection by a geotechnical engineer. Grain-size distribution analysis, limits of consistency and natural water content determinations as well as unconfined compression strength of rock were performed on selected representative samples. The results of these tests are presented in detail in appendix D.

All samples taken during fieldworks and on which no laboratory tests were performed will be preserved for a period of six (6) months as from the date of this report, afterward; they will be discarded unless otherwise stated.

4. SOIL PROFILE AND PROPERTIES

The soil profile determined by boring is shown in table 2 presented hereinafter. A brief description of soil profile at each group is included in the following subsection 5.1 to 5.4. For detailed description, refer to borehole logs enclosed in appendix C.

Table 2: Soil / Rock Profile

Borehole	Top soil / fill	sand	Cohesive soil	Till	Bedrock
Group M					
10BH-04	-	-	0.00-4.72	4.72-11.53	11.53-14.99
10BH-06	-	0.00-0.71	0.71-3.35	3.35-12.39	12.39-15.80
10BH-11	-	-	0.00-2.44	2.44-12.47	12.47-15.62
10BH-12	0.00-0.61	-	0.61-3.05	3.05-14.43	14.43-17.83
10BH-14	0.00-1.52	1.52-12.80	-	-	12.80-16.10
Group N					
10BH-08	0.00-0.46	-	-	0.46-22.56	-
10BH-13	0.00-0.61	-	-	0.61-30.48	-
Group O					
10BH-25	0.00-0.61	-	0.61-4.72	4.72-7.59	7.59-11.15
10BH-27	0.00-0.10	-	0.10-4.77	4.77-10.52	10.52-14.15
10BH-28	0.00-0.15	-	0.15-5.33	5.33-10.67	10.67-13.72
10BH-28A	0.00-0.13	-	0.13-4.93	4.93-11.91	11.91-15.22
10BH-31	0.00-0.18	-	0.18-5.18	5.18-11.66	11.66-15.04
10BH-31A	0.00-0.15	-	0.15-2.90	2.90-12.60	12.60-15.57

Borehole	Top soil / fill	sand	Cohesive soil	Till	Bedrock
Group P					
10BH-05	0.00-1.52	-	-	1.52-7.62	7.62-10.82
10BH-07	0.00-0.20	-	-	0.20-11.07	11.07-15.24
10BH-09	0.00-0.61	-	-	0.61-7.01	7.01-10.85
10BH-10	0.00-0.61	-	-	0.61-20.88	-
10BH-16	0.00-1.52	-	-	1.52-8.91	8.91-12.09
10BH-17	0.00-0.74	-	0.74-3.35	3.35-19.94	-
10BH-18	0.00-0.20	-	-	0.20-6.05	6.05-9.58
10BH-20	0.00-1.83	-	-	1.83-20.17	-
10BH-21	0.00-0.51	0.51-0.86	0.86-1.83	1.83-11.18	11.18-14.33
10BH-22	0.00-0.25	-	-	0.25-12.95	12.95-16.26
10BH-23	0.00-0.10	-	-	0.10-10.72	10.72-13.72
10BH-37	0.00-0.10	-	-	0.10-7.77	7.77-10.52
Group Q					
10BH-26	0.00-0.61	-	-	0.61-5.41	5.41-8.53
10BH-29	0.00-1.17	-	-	1.17-4.04	4.04-6.71
10BH-30	0.00-0.61	-	-	0.61-6.48	6.48-13.23
10BH-32	0.00-0.61	-	-	0.61-6.40	6.40-9.53
10BH-34	0.00-0.18	-	-	0.18-5.08	5.08-9.73
10BH-35	0.00-0.25	-	-	0.25-10.85	10.85-14.17

Note: depths are described in meter and "0.00" indicates ground surface.

4.1 Group M (sites 4, 6, 11, 12, 14)

The soil profile underlying all sites in this group, except site 14, consists of a 3 to 5 m thick clayey soil underlain by a 7 to 10 m thick till deposit followed by the bedrock. In the site 14, the soil profile is composed mainly by a 12 m thick sand deposit followed by the bedrock. In sites 12 and 14 a fill layer or a remoulded native soil is found on the surface.

The clay layer is characterized by the presence of a thin firm grey to brown clayey silt (types CL or ML) followed by a soft grey clay of high plasticity (type CH).

The natural water content measured in soft clay varies between 56 to 74%, the liquid limit ranges from 52 to 65% and the plastic limit varies from 17 to 26%. The in-situ un-drained shear strength varies between 19 and 31 kPa.

The till deposit is composed of silty and sandy soils (type ML and SM), becoming gravelly (type SP) in the last 3 to 5 m before the bedrock. The natural water content varies between 6 (for gravelly soil) and 19% (for silty soil). The obtained SPT N values imply that the density of this deposit is compact (ML and SM) to dense (SP).

The sand deposit found at site 14 consist of a dense sand (SP) becoming gravel and sand (GP) at about 8m deep.

The bedrock consists of grey limestone. The recovery values (recovered rock / core length) vary between 86 and 100% and the RQD values range from 37% (borehole 11) and 100%. The unconfined compressive strength of rock varies between 90 and 117 MPa (106 MPa in average). Based on these results the quality of the bedrock ranges from good to excellent. At borehole 10BH-014 the rock is fractured at surface.

4.2 Group M (sites 8, 13)

The soil profile in this group consists primarily of top soil underlain by a sandy silty till deposit (SM and ML). At about 18 to 20 m deep the till deposit is composed of boulders. The two boreholes were terminated in the till deposit. The density of the first 18 to 20 m of this deposit could be qualified as loose to dense.

4.3 Group O (sites 25, 27, 28, 28A, 31, 31A)

The soil profile at these sites consists of top soil underlain by ± 5 m thick clayey soil underlain by a ± 6 m thick till deposit followed by the bedrock.

The clay layer is composed of a thin stiff grey to brown silty clay (ML-CL) crust followed by a firm grey clay of high plasticity (type CH). The natural water content measured in soft clay varies between 30 to 58%, the liquid limit ranges from 49 to 59% and the plastic limit varies from 15 to 29%. The in-situ un-drained shear strength varies between 22 and 75 kPa.

The till deposit is composed mainly of sand and silt (type ML and SM), becoming gravelly (type SP or GP) with cobbles and boulders in some boreholes. The natural water content varies between 7 to 15%. The density of the till deposit can be qualified as compact to dense.

The bedrock consists of grey to black limestone. The recovery values vary between 69 and 100% and the RQD values range from 13% (borehole 28) and 100%. The unconfined compressive strength of rock varies between 80 and 109 MPa (96 MPa in average). In general, the quality of the bedrock ranges from fair to excellent. At borehole 10BH-28 the rock is fractured through the entire recovered core.

4.4 Group P (sites 5, 7, 9, 10, 16, 17, 18, 20, 21, 22, 23, 37)

The soil profile at the majority of these sites is composed of 6 to 12 m thick till deposit followed by the bedrock. At sites 10, 17 and 20 the boreholes were terminated in the till deposit at about 20 m deep. At sites 17 and 21 the till deposit was overlain by a thin clayey soil layer. In all boreholes top soil/fill layer are topping the soil profile.

The till deposit consists mainly of sand and silt (type ML and SM), becoming gravelly (type SP or GP) with cobbles and boulders in some boreholes. The natural water content of this deposit is $\pm 10\%$. The density of the till deposit can be qualified as loose to dense.

The bedrock consists of grey to black limestone and shale. The recovery values vary between 41 and 100% and the RQD values range from 20% (borehole 5) and 95%. The unconfined compressive strength of rock varies between 68 and 165 MPa (71 MPa in average). In general, the quality of the bedrock ranges from fair to excellent.

4.5 Group Q (sites 26, 29, 30, 32, 34, 35)

The soil profile at the majority of these sites consists of a till deposit followed by the bedrock. At sites 35 the thickness of till deposit is about 10m while in the remaining sites of this group its thickness is about 5m. In all boreholes top soil/fill layer are topping the soil profile.

The till deposit consists mainly of sand and silt (type ML and SM), becoming gravelly with cobbles and boulders in some boreholes. The natural water content of this deposit is $\pm 10\%$. The density of the till deposit can be qualified as compact to dense.

The bedrock consists of black limestone and shale. The recovery values vary between 0 and 100% and the RQD values range from 0% (borehole 30) and 100%. The unconfined compressive strength of rock varies between 75 and 85 MPa (79 MPa in average). In general, in all boreholes except 10BH-30, the quality of the bedrock ranges from fair to excellent. At site 30 the rock was fractured through the entire recovered core.

5. GROUNDWATER OBSERVATION

The following table resumes the groundwater levels measured in boreholes.

Table 3 : Summary of groundwater level

Borehole	Depth (m)	Elevation (m)	Recording date
Group M			
10BH-04	0.00	41.00	April 12, 2010
10BH-06	1.32	40.68	April 12, 2010
10BH-11	0.74	42.26	April 12, 2010
10BH-12	1.00	41.13	April 12, 2010
10BH-14	1.13	42.87	April 12, 2010
Group N			
10BH-08	5.35	45.65	May 6, 2010

Borehole	Depth (m)	Elevation (m)	Recording date
10BH-13	2.55	45.37	May 6, 2010
Group O			
10BH-25	0.92	37.08	April 26, 2010
10BH-27	1.28	33.72	April 26, 2010
10BH-28	0.87	34.13	April 26, 2010
10BH-28A	1.30	-	April 26, 2010
10BH-31	0.26	33.74	April 26, 2010
10BH-31A	0.78	-	April 26, 2010
Group P			
10BH-05	0.00	50.00	April 26, 2010
10BH-07	0.30	48.70	April 26, 2010
10BH-09	0.60	49.40	April 26, 2010
10BH-10	0.00	50.00	April 26, 2010
10BH-16	1.45	49.55	April 26, 2010
10BH-17	0.75	49.25	April 26, 2010
10BH-18	0.00	50.00	April 26, 2010
10BH-20	0.00	49.00	April 26, 2010
10BH-21	0.51	47.49	April 26, 2010
10BH-22	0.80	45.20	April 26, 2010
10BH-23	0.25	46.75	April 26, 2010
10BH-37	0.68	-	April 26, 2010
Group Q			
10BH-26	2.46	38.38	April 26, 2010
10BH-29	1.00	44.00	April 26, 2010
10BH-30	1.65	39.35	April 26, 2010
10BH-32	1.57	41.43	April 26, 2010
10BH-34	0.72	-	April 26, 2010
10BH-35	0.64	-	April 26, 2010

The groundwater conditions depend on different factors, such as seasonal fluctuations, precipitations and modifications made to the physical environment. Therefore, during the excavation works, water inflow could be encountered at levels different from those mentioned in table 3.

6. CONCLUSIONS AND RECOMMANDATIONS

6.1 General comments

It is our understanding that the project includes the construction of 31 energy wind converters. According to the foundation data sheets furnished by the client (copy attached in appendix G), a ring footing is to be used to transmit the converter's loads onto soil mass. The minimum required soil bearing pressure is 242 kPa for a ring foundation of 16.8 m in diameter with buoyancy, and 412 kPa for a ring foundation of 14.2 m in diameter without buoyancy. The differential settlement should not exceed 40 mm.

The depth of groundwater level measured in the majority of boreholes ranges from 0.0 to 2.5 m. These measurement were conducted at spring time (April and May 2010) where the water table is on its highest level (snow melting, precipitation) therefore, it is possible that the water level will drop beneath the footing base (2.85 m according to data sheets) during dry seasons. As a result, the "without buoyancy" load case is considered in the shallow foundation design.

In general, the seismic investigation carried out on the subject sites (MASW tests) yields the same results as the conventional borehole investigation.

Based upon the information gathered from boreholes and seismic investigations, the geotechnical recommendations for the proposed construction are presented in the following sections.

6.2 Foundation design

Based on the geotechnical properties of soil and rock underlying the proposed constructions, the depth of the competent soil is determined for each site. The depth of the competent soil is defined as the depth, measured from the ground surface, at which the anticipated pressure (412 kPa) can be transferred to the soil mass/rock without causing a shear failure in the soil mass or/and excessive settlement caused by static or dynamic loads (<40 mm). A factor of safety of 3 (FS = 3) is considered against shear failure. The type of foundation (shallow or deep) is determined based on the depth of the competent strata.

Table 4 : Depth of competent soil and type of foundation

Site	Competent soil / rock		Foundation type
	Type	Depth (m)	
Group M			
4	Bedrock	±13	Deep foundation
6	Bedrock	±13	Deep foundation
11	Bedrock	±13	Deep foundation
12	Bedrock	±15	Deep foundation
14	Bedrock	±13	Deep foundation
Group N			
8	Till deposit	±17	Deep foundation
13	Till deposit	±17	Deep foundation

Site	Competent soil / rock		Foundation type
	Type	Depth (m)	
Group O			
25	Bedrock	±8	Deep foundation
27	Bedrock	±11	Deep foundation
28	Bedrock	±11	Deep foundation
28a	Bedrock	±12	Deep foundation
31	Bedrock	±12	Deep foundation
31a	Bedrock	±13	Deep foundation
Group P			
5	Bedrock	±10	Deep foundation
7	Bedrock	±13	Deep foundation
9	Bedrock	±8	Deep foundation
10	Till deposit	±12	Deep foundation
16	Bedrock	±12	Deep foundation
17	Till deposit	±10	Deep foundation
18	Till deposit	±5	Shallow foundation
20	Till deposit	±15	Deep foundation
21	Bedrock	±11	Deep foundation
22	Bedrock	±13	Deep foundation
23	Till deposit	±5	Shallow foundation
37	Till deposit	±5	Shallow foundation
Group Q			
26	Bedrock	±5	Shallow foundation
29	Till deposit	±3	Shallow foundation
30	Till deposit	±3	Shallow foundation
32	Till deposit	±5	Shallow foundation
34	Bedrock	±5	Shallow foundation
35	Bedrock	±12	Deep foundation

6.2.1 Shallow foundation

All compressible soils (CH or CL), organic soil and fill must be removed from within the footprints of proposed footings. The foundations must be placed under a minimum of 1.5 m earth cover in order to be adequately protected against frost effects.

For some sites the depth of competent soil/rock is located at about 5m. For these sites, it is possible to elevate the competent soil surface level to the desired elevation.

This should be carried out using a well graded granular materials complying with the grain size distribution given in table 5, compacted to 98% of Standard Proctor maximum dry density and placed in 300 mm lift thickness.

Table 5 : Grain size distribution

Grain size (mm)	% passing
31.5	100
20	90 -100
14	68 - 93
5	35 – 60
1.25	19 – 38
0.315	9 – 17
0.080	2 – 7

6.2.2 Deep foundation

As illustrated in table 5, twenty-three (23) out of thirty-one (31) wind energy converters are to be supported by a deep foundation system. Based on the geotechnical properties of subsoil encountered at these sites, driven steel H-piles end-bearing on the surface of good quality bedrock or into a very dense till deposit could be used for this purpose. A cast steel drive shoes should be used to protect the toe of pile when driving through boulders.

For sites where piles are to be driven to bedrock. The ultimate axial capacity of bedrock is estimated at 5000 kPa. The estimated capacity includes a factor of safety of 3. The settlement for pile driven into sound bedrock is normally negligible providing that the contact between pile toe and rock is assured.

For sites 8, 13, 10, 17 and 20 the anticipated load will be transferred by means of end-bearing piles driven into the till deposit. The values of estimated ultimate axial capacity of till deposit at the piles toe level is shown in table 6.

Table 6 : Allowable bearing capacity of pile toe end-bearing on till deposit

Site	Estimated depth of competent soil (till deposit)	Allowable bearing pressure of pile toe (kPa)
8	±17	3000
13	±17	3000
10	±12	2000
17	±10	1750
20	±15	2600

The toe of pile should be driven at least six (6) times its diameter into the competent soil in order to mobilize the full axial end-bearing capacity mentioned in the table 6. The estimated capacity includes a factor of safety of 3.

The lateral capacity of piles can be determined using Broms' method. This method is presented in section 18.4.1 of the Canadian Foundation Engineering Manual. The Broms' method estimates the ultimate lateral resistance of piles using graphical charts (copies are enclosed in appendix G). The soil parameters mentioned in tables 8 to 12 could be used for this matter. A reduction factor should be applied for pile group.

Table 7 : Reduction factor for lateral resistance

Pile spacing (center to center)	Reduction factor
8b	1,0
6b	0,8
4b	0,5
3b	0,4

b = pile diameter

The ultimate loads capacity of piles must be verified by means of static and dynamic load tests as per ASTM procedures.

6.3 soils geotechnical properties

The geotechnical properties for subsoil underlying the subject sites are determined based on the information obtained from boreholes and seismic investigations. They are presented in the following tables.

Table 8 : Soil properties – Group M (Sites 4, 6, 11, 12 and 14)

Parameter/soil	Clay	Till	Sand
Total unit weight γ (kN/m ³)	18	18	18
Submerged unit weight γ' (kN/m ³)	8	8	8
Effective friction angle ϕ' (°)	25	28	30
Effective cohesion C' (kPa)	5	0	0
Un-drained shear strength C_u (kPa)	See logs	0	0
Poisson's ratio ν	0.35	0.25	0.25
Elastic stiffness modulus E (MPa)	10	15	20
Shear modulus G (MPa)	3.7	6	8

Table 9 : Soil properties – Group N (Sites 8 and 13)

Parameter/soil	Clay	Till From 0 to 17m	Till >17m
Total unit weight γ (kN/m ³)	-	18	20
Submerged unit weight γ' (kN/m ³)	-	8	10
Effective friction angle ϕ' (°)	-	28	34
Effective cohesion C' (kPa)	-	0	0
Un-drained shear strength C_u (kPa)	-	0	0
Poisson`s ratio ν	-	0.25	0.25
Elastic stiffness modulus E (MPa)	-	15	100
Shear modulus G (MPa)	-	6	40

Table 10 : Soil properties – Group O (Sites 25, 27, 28, 28A, 31 and 31A)

Parameter/soil	Clay	Till	Sand
Total unit weight γ (kN/m ³)	18	18	
Submerged unit weight γ' (kN/m ³)	8	8	-
Effective friction angle ϕ' (°)	25	30	-
Effective cohesion C' (kPa)	5	0	-
Un-drained shear strength C_u (kPa)	See logs	0	-
Poisson`s ratio ν	0.35	0.25	-
Elastic stiffness modulus E (MPa)	10	35	-
Shear modulus G (MPa)	3.7	14	-

Table 11: Soil properties – Group P (Sites 5, 7, 9, 10, 16, 17, 18, 20, 21, 22, 23 and 37)

Parameter/soil	Clay	Till From 0 to ± 5 m	Till >5m
Total unit weight γ (kN/m ³)	18	18	18
Submerged unit weight γ' (kN/m ³)	8	8	8
Effective friction angle ϕ' (°)	25	28	32
Effective cohesion C' (kPa)	5	0	0

Parameter/soil	Clay	Till From 0 to ± 5 m	Till >5m
Un-drained shear strength C_u (kPa)	See logs	0	0
Poisson`s ratio ν	0.35	0.25	0.25
Elastic stiffness modulus E (MPa)	10	15	40
Shear modulus G (MPa)	3.7	6	16

Table 12 : Soil properties – Group Q (Sites 26, 29, 30, 32, 34 and 35)

Parameter/soil	Clay	Till	Sand
Total unit weight γ (kN/m ³)	-	18	-
Submerged unit weight γ' (kN/m ³)	-	8	-
Effective friction angle ϕ' ($^\circ$)	-	32	-
Effective cohesion C' (kPa)	-	0	-
Un-drained shear strength C_u (kPa)	-	0	-
Poisson`s ratio ν	-	0.25	-
Elastic stiffness modulus E (MPa)	-	40	-
Shear modulus G (MPa)	-	16	-

6.4 Temporary excavation and drainage

According to the stratigraphy identified in the boreholes carried out at subject sites, for an excavation of about 3 to 5 m in depth, the excavation will take place mainly in the soft clay layer or the loose to compact till or sand layers. Therefore, temporary slopes must be shaped with inclinations of 1.0 vertically to 3.0 horizontally (1V : 3H) or flatter, depending on density and/or consistency of materials to be encountered.

Moreover, based on measured water level (see table 3) groundwater will seep into the excavations. In addition, the bottom and slopes of excavation in the majority of subject sites is composed of a loose saturated fine silty soil. This type of soil is very sensitive against remoulding and it could loose significant amount of its strength if remoulded. Therefore, in order to maintain a stable bottom and slope of the excavation, water level must be lowered to at least **0.60 m** below the bottom of excavation grade. The contractor must consider the use of a proper pumping system in order to eliminate the surface and seepage water to avoid its accumulation at the bottom of excavation; allowing working in a dry environment.

It is very important to underline that the contractor is **solely responsible** for the design of such pumping system that is capable of maintaining a dry bottom excavation as described in the aforementioned paragraph.

6.5 *site classification for seismic site response*

Based on the seismic investigation carried at the subject sites (see appendix E), the majority of sites is classified as class C. The following table summarises sites classes.

Table 13 : Site classification for seismic site response

Sites	Class
29, 30, 32, 34 and 37	B
All remaining sites	C
6	D

7. LIMITATIONS OF THE STUDY

Soil description and properties presented in the preceding sections and boreholes log reports, are valid only where the boreholes were performed. Therefore, it is very possible that soil found during execution of work may vary from those studied; any notable variation or discrepancy between descriptions provided in this report and those found must be reported to Groupe ABS Inc. promptly.

Prepared by : Ibrahim Ja'far, Eng., M.Eng.

Verified by: Ursula Maselbas, Eng., M.A.Sc.

IJ/UM//sm

Appendix A

Google satellite photos

TRANSALTA CORPORATION

Geotechnical study – Construction of wind energy converters
Terrains located in the vicinity of the town of St-Valentin in Quebec

O/F : G1-09-1532



© 2010 Google

Figure 1 : Satellite photo – Group M

TRANSALTA CORPORATION

Geotechnical study – Construction of wind energy converters
Terrains located in the vicinity of the town of St-Valentin in Quebec

O/F : G1-09-1532



© 2010 Google

Figure 1 : Satellite photo – Group N

TRANSALTA CORPORATION

Geotechnical study – Construction of wind energy converters
Terrains located in the vicinity of the town of St-Valentin in Quebec

O/F : G1-09-1532



© 2010 Google

Figure 1 : Satellite photo – Group O

TRANSALTA CORPORATION

Geotechnical study – Construction of wind energy converters
Terrains located in the vicinity of the town of St-Valentin in Quebec

O/F : G1-09-1532



© 2010 Google

Figure 1 : Satellite photo – Group P

TRANSALTA CORPORATION

Geotechnical study – Construction of wind energy converters
Terrains located in the vicinity of the town of St-Valentin in Quebec

O/F : G1-09-1532



© 2010 Google

Figure 1 : Satellite photo – Group Q

Appendix B

Key-Plan

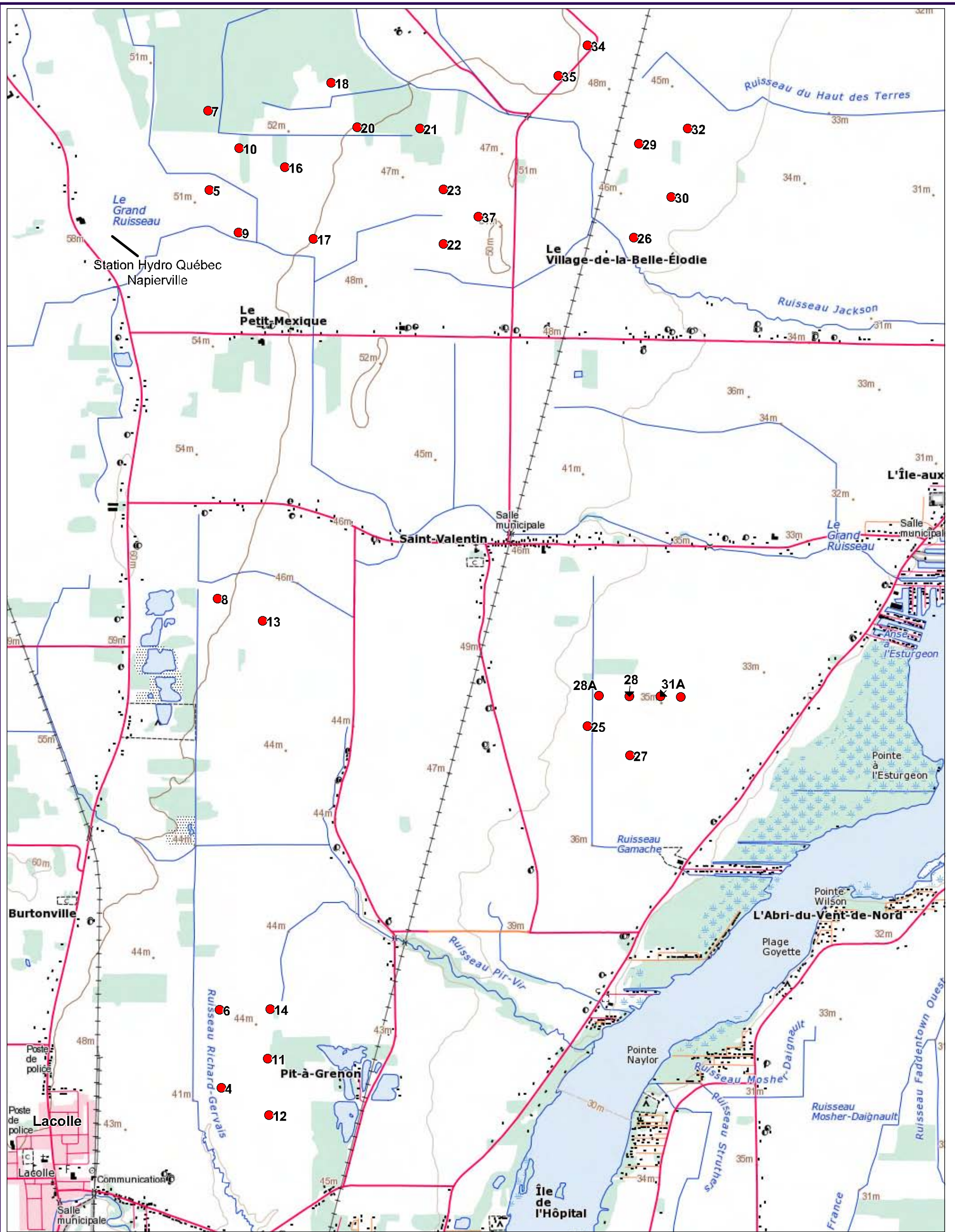

VENTERRE
Énergie

**Parc Éolien Saint-Valentin
 Québec
 MRC Haut-Richelieu
 Geo Technical Study**

Légende

● Drill locations

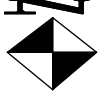

**Échelle:
 1:40 000
 (sur 11 x 17)**







UTM NAD 83 Zone 18
 STV_M136_CPK 14/06/2010

Appendix C

Borehole logs

Project : **Wind Energy Converters (WEC)**
 Client : **TRANSALTA**
 Location : **Saint-Valentin, Québec**
 Drilling contractor : **Explora-sol inc.**
 Drilling type : **Casing**
 Diameter : **76,2 mm**
 Field technician : **Karim Boudalia, géo.**

O/F : **G1-09-1532**
 Geodesic coordinates (NAD-1983) X: **316244**
 Y: **5002438**
 Date of drilling : **2010-04-01**
 Drilling depth (m) : **15.24**

SOIL STATE  Disturbed  Intact  Lost  Core sample	TERMINOLOGY "traces" 1-10% "some" 10-20% adjective (sandy...) 20-35% "and" 35-50% SYMBOLS N N-value (Standard penetration test) R Refusal R.Q.D Rock Quality Designation % R.Q.D Σ Length of sound pieces > 100 mm Total core run length	ROCK QUALITY DESIGNATION % RQD QUALITATIVE <25 Very poor 25-50 Poor 50-75 Fair 75-90 Good 90-100 Excellent	COMPACTION INDEX "N" Very loose 0-4 Loose 4-10 Compact 10-30 Dense 30-50 Very dense >50	WATER LEVEL (m) Date: 2010-04-26 Date: Depth: 0.30 Depth:
TYPE OF SAMPLES SS Split Spoon ST Shelby tube HA Helical auger RC Roc core barrel CA Casing MA Manual	CLASSIFICATION Clay < 0,002 mm Silt 0,002 à 0,08 mm Sand 0,08 à 5 mm Gravel 5 à 80 mm Cobbles 80 à 300 mm Boulders > 300 mm	COHESIVE SOILS CONSISTENCY Very soft Soft Firm Stiff Very stiff Hard	SHEAR STRENGTH (Cu) <12 kPa 12-25 kPa 25-50 kPa 50-100 kPa 100-200 kPa >200 kPa	 Water infiltration  Groundwater table

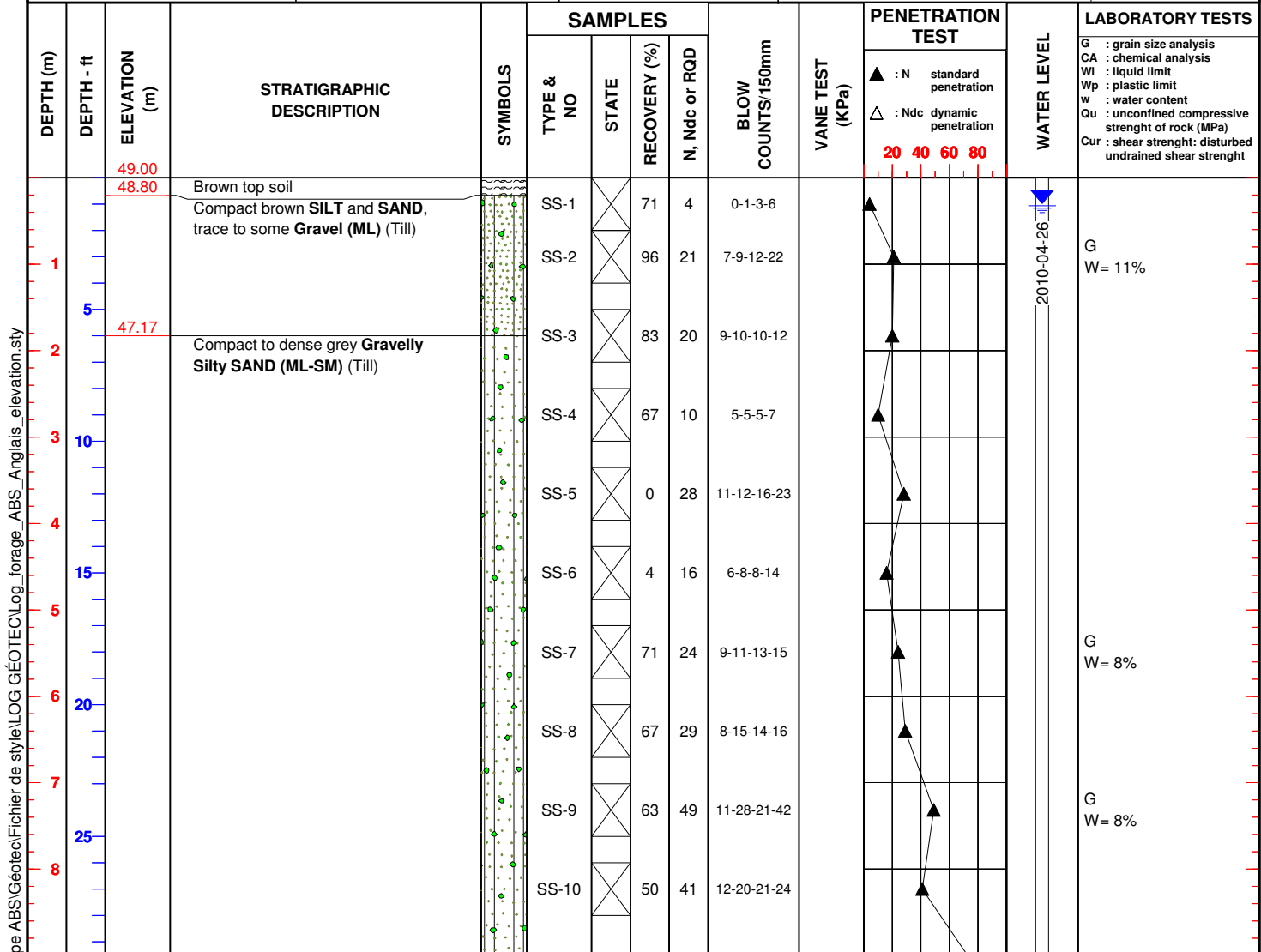





Remark(s):

DEPTH (m)	DEPTH - ft	ELEVATION (m)	STRATIGRAPHIC DESCRIPTION	SYMBOLS	SAMPLES				BLOW COUNTS/150mm	VANE TEST (KPa)	PENETRATION TEST				WATER LEVEL	LABORATORY TESTS
					TYPE & NO	STATE	RECOVERY (%)	N, Ndc or RQD			▲ : N standard penetration	△ : Ndc dynamic penetration	20	40		
10	35	37.93	Bedrock: Black LIMESTONE , poor to excellent quality		SS-11	⊗	80	84	-34-50 / 10 cm						Qu = 165	
11					SS-12	⊗	100	83	-33-50 / 10 cm							
12	40				RC-13	█	41	35								
13	45				RC-14	█	60	61								
14	50	33.76			RC-15	█	98	94								
15			END OF BOREHOLE													
16	55															
17	60															
18	65															
19	70															
20	75															
21	80															
22																
23																
24																
25																

Borehole N°
10BH-04

Project : **Wind Energy Converters (WEC)**
 Client : **TRANSALTA**
 Location : **Saint-Valentin, Québec**
 Drilling contractor : **Explora-sol inc.**
 Drilling type : **Casing**
 Diameter : **76,2 mm**
 Field technician : **Bernard Huppé, géo.**

O/F : **G1-09-1532**
 Geodesic coordinates (NAD-1983) X: **316203**
 Y: **4994292**
 Date of drilling : **2010-03-10**
 Drilling depth (m) : **14.99**

SOIL STATE  Disturbed  Intact  Lost  Core sample	TERMINOLOGY "traces" 1-10% "some" 10-20% adjective (sandy...) 20-35% "and" 35-50% SYMBOLS N N-value (Standard penetration test) R Refusal R.Q.D Rock Quality Designation % R.Q.D Σ Length of sound pieces > 100 mm Total core run length	ROCK QUALITY DESIGNATION % RQD QUALITATIVE <25 Very poor 25-50 Poor 50-75 Fair 75-90 Good 90-100 Excellent	COMPACTION INDEX "N" Very loose 0-4 Loose 4-10 Compact 10-30 Dense 30-50 Very dense >50	WATER LEVEL (m) Date: 2010-04-12 Date: Depth: 0.00 Depth:
TYPE OF SAMPLES SS Split Spoon ST Shelby tube HA Helical auger RC Roc core barrel CA Casing MA Manual	CLASSIFICATION Clay < 0,002 mm Silt 0,002 à 0,08 mm Sand 0,08 à 5 mm Gravel 5 à 80 mm Cobbles 80 à 300 mm Boulders > 300 mm		COHESIVE SOILS CONSISTENCY Very soft Soft Firm Stiff Very stiff Hard	SHEAR STRENGTH (Cu) <12 kPa 12-25 kPa 25-50 kPa 50-100 kPa 100-200 kPa >200 kPa

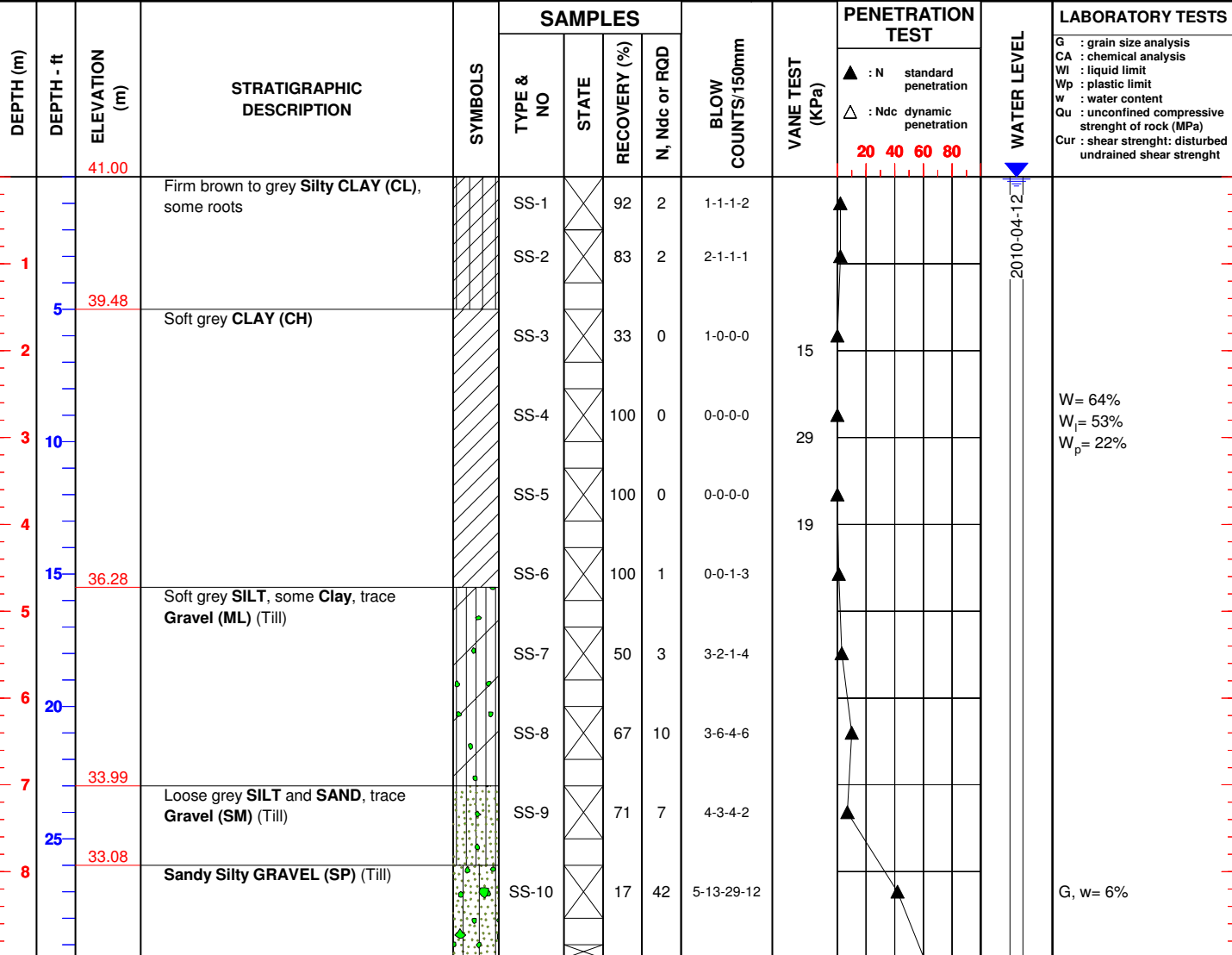







Remark(s):

DEPTH (m)	DEPTH - ft	ELEVATION (m)	STRATIGRAPHIC DESCRIPTION	SYMBOLS	SAMPLES				BLOW COUNTS/150mm	VANE TEST (KPa)	PENETRATION TEST				WATER LEVEL	LABORATORY TESTS
					TYPE & NO	STATE	RECOVERY (%)	N, Ndc or RQD			▲ : N standard penetration	△ : Ndc dynamic penetration	20	40		
10	35	29.47	Bedrock: Grey LIMESTONE, good to excellent quality		SS-11	X	29	62	-43-19-50 / 13 cm							
					SS-12	X	54	40	22-20-20-27							
11					SS-13	X	75	69	-19-50							
12	40		END OF BOREHOLE		RC-14		100	93					Qu= 113			
13	45				RC-15		100	79								
14	50	26.01														
15	55															
16	60															
17	65															
18	70															
19	75															
20	80															
21																
22																
23																
24																
25																

Borehole N°
10BH-05

Project : **Wind Energy Converters (WEC)**
 Client : **TRANSALTA**
 Location : **Saint-Valentin, Québec**
 Drilling contractor : **Explora-sol inc.**
 Drilling type : **Casing**
 Diameter : **76,2 mm**
 Field technician : **Rock Samson, tech.**

O/F : **G1-09-1532**
 Geodesic coordinates (NAD-1983) X: **316239**
 Y: **5001777**
 Date of drilling : **2010-03-31**
 Drilling depth (m) : **10.82**

SOIL STATE  Disturbed  Intact  Lost  Core sample	TERMINOLOGY "traces" 1-10% "some" 10-20% adjective (sandy...) 20-35% "and" 35-50% SYMBOLS N N-value (Standard penetration test) R Refusal R.Q.D Rock Quality Designation % R.Q.D Σ Length of sound pieces > 100 mm Total core run length	ROCK QUALITY DESIGNATION % RQD QUALITATIVE <25 Very poor 25-50 Poor 50-75 Fair 75-90 Good 90-100 Excellent	COMPACTION INDEX "N" Very loose 0-4 Loose 4-10 Compact 10-30 Dense 30-50 Very dense >50	WATER LEVEL (m) Date: 2010-04-26 Date: Depth: 0.00 Depth:
TYPE OF SAMPLES SS Split Spoon ST Shelby tube HA Helical auger RC Roc core barrel CA Casing MA Manual	CLASSIFICATION Clay < 0,002 mm Silt 0,002 à 0,08 mm Sand 0,08 à 5 mm Gravel 5 à 80 mm Cobbles 80 à 300 mm Boulders > 300 mm	COHESIVE SOILS CONSISTENCY Very soft Soft Firm Stiff Very stiff Hard	SHEAR STRENGTH (Cu) <12 kPa 12-25 kPa 25-50 kPa 50-100 kPa 100-200 kPa >200 kPa	 Water infiltration  Groundwater table

DEPTH (m)	DEPTH - ft	ELEVATION (m)	STRATIGRAPHIC DESCRIPTION	SYMBOLS	SAMPLES			BLOW COUNTS/150mm	VANE TEST (kPa)	PENETRATION TEST				WATER LEVEL	LABORATORY TESTS
					TYPE & NO	STATE	RECOVERY (%)			N _j Ndc or RQD	20	40	60		
		50.00	Brown Silty SAND, roots (Fill)		SS-1	X	63	5	1-2-3-6						
1					SS-2	X	79	19	7-9-10-15						
		48.48	Compact grey SAND and SILT, trace to some Clay, trace Gravel (ML-SM) (Till)		SS-3	X	4	9	3-4-5-6						
2					SS-4	X	46	9	3-3-6-8						
3					SS-5	X	42	25	11-13-12-8						
4					SS-6	X	0	26	10-11-15-11						
5		44.82	Firm to stiff Clayey SILT (CL) (Till)		SS-7	X	67	14	4-6-8-8						G W= 10%
6					SS-8	X	54	5	1-2-3-4						
7		42.99	Dense grey Gravelly SAND, some Silt (SG) (Till)		SS-9	X	42	25	-12-13-50 / 5 cm						
8		42.38	Bedrock: Light grey LIMESTONE and SHALE, very poor to good quality		RC-10		90								
					RC-11		100								
					RC-12		100								







Remark(s):



DEPTH (m)	DEPTH - ft	ELEVATION (m)	STRATIGRAPHIC DESCRIPTION	SYMBOLS	SAMPLES				BLOW COUNTS/150mm	VANE TEST (KPa)	PENETRATION TEST				WATER LEVEL	LABORATORY TESTS
					TYPE & NO	STATE	RECOVERY (%)	N, Ndc or RGD			▲ : N standard penetration	△ : Ndc dynamic penetration	20	40		
10				[Brick Pattern]												
	35	39.18			RC-13	[Redacted]	100	83								Qu= 86
11			END OF BOREHOLE													
12																
13																
14																
15																
16																
17																
18																
19																
20																
21																
22																
23																
24																
25																

Borehole N° 10BH-06

Project : **Wind Energy Converters (WEC)**
 Client : **TRANSALTA**
 Location : **Saint-Valentin, Québec**
 Drilling contractor : **Explora-sol inc.**
 Drilling type : **Casing**
 Diameter : **76,2 mm**
 Field technician : **Bernard Huppé, géo.**

O/F : **G1-09-1532**
 Geodesic coordinates (NAD-1983) X: **316202**
 Y: **4994943**
 Date of drilling : **2010-03-11**
 Drilling depth (m) : **15.80**

SOIL STATE  Disturbed  Intact  Lost  Core sample	TERMINOLOGY "traces" 1-10% "some" 10-20% adjective (sandy...) 20-35% "and" 35-50% SYMBOLS N N-value (Standard penetration test) R Refusal R.Q.D Rock Quality Designation % R.Q.D Σ Length of sound pieces > 100 mm Total core run length	ROCK QUALITY DESIGNATION % RQD QUALITATIVE <25 Very poor 25-50 Poor 50-75 Fair 75-90 Good 90-100 Excellent	COMPACTION INDEX "N" Very loose 0-4 Loose 4-10 Compact 10-30 Dense 30-50 Very dense >50	WATER LEVEL (m) Date: 2010-04-12 Date: Depth: 1.32 Depth:
TYPE OF SAMPLES SS Split Spoon ST Shelby tube HA Helical auger RC Roc core barrel CA Casing MA Manual	CLASSIFICATION Clay < 0,002 mm Silt 0,002 à 0,08 mm Sand 0,08 à 5 mm Gravel 5 à 80 mm Cobbles 80 à 300 mm Boulders > 300 mm	COHESIVE SOILS CONSISTENCY Very soft Soft Firm Stiff Very stiff Hard	SHEAR STRENGTH (Cu) <12 kPa 12-25 kPa 25-50 kPa 50-100 kPa 100-200 kPa >200 kPa	 Water infiltration  Groundwater table

DEPTH (m)	DEPTH - ft	ELEVATION (m)	STRATIGRAPHIC DESCRIPTION	SYMBOLS	SAMPLES			BLOW COUNTS/150mm	VANE TEST (kPa)	PENETRATION TEST				WATER LEVEL	LABORATORY TESTS
					TYPE & NO	STATE	RECOVERY (%)			N _j Ndc or RQD	▲ : N standard penetration	△ : Ndc dynamic penetration	20		
		42.00	Brown SAND, trace Silt (SP)		SS-1	X	75	24	1-7-17-9						
1		41.29	Soft grey CLAY (CH)		SS-2	X	79	5	3-2-3-3						
2	5				SS-3	X	100	0	0-0-0-1	31					
3	10	38.65	Compact grey SILT, trace to some Sand (ML) (Till)		SS-4	X	100	0	0-0-0-0	23					
4					SS-5	X	75	9	2-4-5-7						
5	15				SS-6	X	71	14	6-7-7-11						
6	20				SS-7	X	67	15	6-7-8-10						
7					SS-8	X	75	13	6-5-8-9						
8	25				SS-9	X	75	10	5-5-5-5						
		33.16			SS-10	X	58	28	6-9-19-36						







Remark(s):

DEPTH (m)	DEPTH - ft	ELEVATION (m)	STRATIGRAPHIC DESCRIPTION	SYMBOLS	SAMPLES			BLOW COUNTS/150mm	VANE TEST (KPa)	PENETRATION TEST				WATER LEVEL	LABORATORY TESTS
					TYPE & NO	STATE	RECOVERY (%)			N ₁ Ndc or RQD	▲ : N standard penetration	△ : Ndc dynamic penetration	20		
10	35		Compact grey SILT , some Gravel and Sand (ML) (Till)		SS-11	X	4	19	7-8-11-10						G, w= 15%
					SS-12	X	4	11	6-6-5-10						
11					SS-13	X	4	17	12-10-7-10						
12	40	29.61	Bedrock: Grey LIMESTONE , fair to excellent quality		RC-14			100	100						Qu= 106
13	45				RC-15			86	70						
14	50				RC-16			100	90						
15	55	26.20	END OF BOREHOLE												
16															
17	60														
18	65														
19	70														
20	75														
21	80														
22															
23															
24															
25															

Borehole N°
10BH-08



Project : **Wind Energy Converters (WEC)**
 Client : **TRANSALTA**
 Location : **Saint-Valentin, Québec**
 Drilling contractor : **Explora-sol inc.**
 Drilling type : **Casing**
 Diameter : **76,2 mm**
 Field technician : **Bernard Huppé, géo.**

O/F : **G1-09-1532**
 Geodesic coordinates (NAD-1983) X: **316248**
 Y: **4998369**
 Date of drilling : **2010-03-17**
 Drilling depth (m) : **22.56**

SOIL STATE  Disturbed  Intact  Lost  Core sample	TERMINOLOGY "traces" 1-10% "some" 10-20% adjective (sandy...) 20-35% "and" 35-50% SYMBOLS N N-value (Standard penetration test) R Refusal R.Q.D Rock Quality Designation % R.Q.D Σ Length of sound pieces > 100 mm Total core run length	ROCK QUALITY DESIGNATION % RQD QUALITATIVE <25 Very poor 25-50 Poor 50-75 Fair 75-90 Good 90-100 Excellent	COMPACTION INDEX "N" Very loose 0-4 Loose 4-10 Compact 10-30 Dense 30-50 Very dense >50	WATER LEVEL (m) Date: 2010-05-06 Date: Depth: 5.35 Depth:	
TYPE OF SAMPLES SS Split Spoon ST Shelby tube HA Helical auger RC Roc core barrel CA Casing MA Manual	CLASSIFICATION Clay < 0,002 mm Silt 0,002 à 0,08 mm Sand 0,08 à 5 mm Gravel 5 à 80 mm Cobbles 80 à 300 mm Boulders > 300 mm		COHESIVE SOILS CONSISTENCY Very soft Soft Firm Stiff Very stiff Hard	SHEAR STRENGTH (Cu) <12 kPa 12-25 kPa 25-50 kPa 50-100 kPa 100-200 kPa >200 kPa	 Water infiltration  Groundwater table

DEPTH (m)	DEPTH - ft	ELEVATION (m)	STRATIGRAPHIC DESCRIPTION	SYMBOLS	SAMPLES			BLOW COUNTS/150mm	VANE TEST (kPa)	PENETRATION TEST				WATER LEVEL	LABORATORY TESTS
					TYPE & NO	STATE	RECOVERY (%)			N _j Ndc or RQD	20	40	60		
		51.00								▲ : N standard penetration △ : Ndc dynamic penetration					
		50.54	Brown Silty SAND, trace Gravel and organic soil		SS-1	×	67	4	1-1-3-6	▲					
1		49.81	Compact brown SILT, some Sand, trace Gravel (ML) (Till)		SS-2	×	75	26	7-10-16-27	▲					
2	5		Loose to compact grey SILT and SAND, trace to some Gravel and Clay (Till). (ML)		SS-3	×	75	21	8-11-10-12	▲					
3	10			SS-4	×	75	11	5-5-6-9	▲						
4				SS-5	×	75	9	3-3-6-6	▲						
5	15			SS-6	×	79	6	3-3-3-6	▲						
6	20			SS-7	×	0	7	3-2-5-8	▲						
7			SS-8	×	79	8	3-4-4-7	▲							
8	25		SS-9	×	0	15	5-6-9-17	▲							
		42.47	Compact grey SILT, trace to some Sand		SS-10	×	46	40	9-11-29-33	▲					

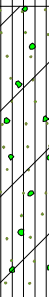
Remark(s):

DEPTH (m)	DEPTH - ft	ELEVATION (m)	STRATIGRAPHIC DESCRIPTION	SYMBOLS	SAMPLES			BLOW COUNTS/150mm	VANE TEST (KPa)	PENETRATION TEST				WATER LEVEL	LABORATORY TESTS
					TYPE & NO	STATE	RECOVERY (%)			N, Ndc or RGD	▲ : N standard penetration	△ : Ndc dynamic penetration	20		
10			Loose to compact grey Sandy SILT , some Gravel and Clay (SM) (Till)		SS-11	X	75	27	11-12-15-19		▲				G W= 16%
					SS-12	X	79	23	8-10-13-17		▲				
11		39.88			SS-13	X	63	13	6-7-6-20		▲				
12					SS-14	X	71	33	14-15-18-19		▲				
13					SS-15	X	58	3	5-1-2-5		▲				
14			Very dense grey SILT , some Sand . Presence of Cobbles (ML)		SS-16	X	79	21	13-9-12-24		▲			G W= 8%	
15					SS-17	X	80	50	/ 13 cm		▲				
16					SS-18	X	40	50	/ 13 cm		▲				
17		34.24	BOULDERS: Over consolidated till		RC-19	█	100	61							
18					RC-20	█	100	82							
19		31.62			RC-21	█	100	90							
20					END OF BOREHOLE										
21		28.45													
22															
23															
24															
25															

Project : **Wind Energy Converters (WEC)**
 Client : **TRANSALTA**
 Location : **Saint-Valentin, Québec**
 Drilling contractor : **Explora-sol inc.**
 Drilling type : **Casing**
 Diameter : **76,2 mm**
 Field technician : **Rock Samson, tech.**

O/F : **G1-09-1532**
 Geodesic coordinates (NAD-1983) X: **316478**
 Y: **5001418**
 Date of drilling : **2010-03-29**
 Drilling depth (m) : **10.85**

SOIL STATE Disturbed Intact Lost Core sample	TERMINOLOGY "traces" 1-10% "some" 10-20% adjective (sandy...) 20-35% "and" 35-50%	ROCK QUALITY DESIGNATION % RQD QUALITATIVE <25 Very poor 25-50 Poor 50-75 Fair 75-90 Good 90-100 Excellent	COMPACTION INDEX "N" Very loose 0-4 Loose 4-10 Compact 10-30 Dense 30-50 Very dense >50	WATER LEVEL (m) Date: 2010-04-26 Date: Depth: 0.60 Depth:
	SYMBOLS N N-value (Standard penetration test) R Refusal R.Q.D Rock Quality Designation % R.Q.D Σ Length of sound pieces > 100 mm Total core run length	CLASSIFICATION Clay < 0,002 mm Silt 0,002 à 0,08 mm Sand 0,08 à 5 mm Gravel 5 à 80 mm Cobbles 80 à 300 mm Boulders > 300 mm	COHESIVE SOILS CONSISTENCY Very soft Soft Firm Stiff Very stiff Hard	SHEAR STRENGTH (Cu) <12 kPa 12-25 kPa 25-50 kPa 50-100 kPa 100-200 kPa >200 kPa





DEPTH (m)	DEPTH - ft	ELEVATION (m)	STRATIGRAPHIC DESCRIPTION	SYMBOLS	SAMPLES			BLOW COUNTS/150mm	VANE TEST (kPa)	PENETRATION TEST				WATER LEVEL	LABORATORY TESTS
					TYPE & NO	STATE	RECOVERY (%)			N _j Ndc or RQD	▲ : N standard penetration	△ : Ndc dynamic penetration	20		
		50.00	Brown Sandy SILT , roots (Fill)												
1		49.39	Compact brown SILT and SAND , trace Gravel (ML) (Till)		SS-1	⊗	25	7	1-2-5-3						
2	5				SS-2	⊗	96	14	3-7-7-20						
3	10	47.56	Dense grey Sandy SILT , trace to some Gravel . Presence of Cobbles (ML) (Till)		SS-3	⊗	50	35	13-17-18-16						
4	15				SS-4	⊗	38	30	4-13-17-14						
5	20				SS-5	⊗	33	44	11-22-22-34						
6	25				SS-6	⊗	50	59	22-34-25-26						
7		42.99	Bedrock: Light grey LIMESTONE and SHALE , good quality		SS-7	⊗	58	71	-22-49-50 / 15 cm						
8					SS-8	⊗	21	50	/ 10 cm						
					SS-9	⊗		40	-40 / 3 cm						
					RC-10	■	100	74							
					RC-11	■	90	85							

Remark(s):

DEPTH (m)	DEPTH - ft	ELEVATION (m)	STRATIGRAPHIC DESCRIPTION	SYMBOLS	SAMPLES			BLOW COUNTS/150mm	VANE TEST (KPa)	PENETRATION TEST				WATER LEVEL	LABORATORY TESTS
					TYPE & NO	STATE	RECOVERY (%)			N, Ndc or RGD	▲ : N standard penetration	△ : Ndc dynamic penetration	20		
10				[Brick pattern]	RC-12		90	86							
11	35	39.15	END OF BOREHOLE												
12															
13															
14															
15															
16															
17															
18															
19															
20															
21															
22															
23															
24															
25															

Project : **Wind Energy Converters (WEC)**
 Client : **TRANSALTA**
 Location : **Saint-Valentin, Québec**
 Drilling contractor : **Explora-sol inc.**
 Drilling type : **Casing**
 Diameter : **76,2 mm**
 Field technician : **Karim Boudalia, géo.**

O/F : **G1-09-1532**
 Geodesic coordinates (NAD-1983) X: **316497**
 Y: **5002120**
 Date of drilling : **2010-03-30**
 Drilling depth (m) : **20.88**

SOIL STATE  Disturbed  Intact  Lost  Core sample	TERMINOLOGY "traces" 1-10% "some" 10-20% adjective (sandy...) 20-35% "and" 35-50%	ROCK QUALITY DESIGNATION % RQD QUALITATIVE <25 Very poor 25-50 Poor 50-75 Fair 75-90 Good 90-100 Excellent	COMPACTION INDEX "N" Very loose 0-4 Loose 4-10 Compact 10-30 Dense 30-50 Very dense >50	WATER LEVEL (m) Date: 2010-04-26 Date: Depth: 0.00 Depth:
	TYPE OF SAMPLES SS Split Spoon ST Shelby tube HA Helical auger RC Roc core barrel CA Casing MA Manual	SYMBOLS N N-value (Standard penetration test) R Refusal R.Q.D Rock Quality Designation % R.Q.D Σ Length of sound pieces > 100 mm Total core run length	CLASSIFICATION Clay < 0,002 mm Silt 0,002 à 0,08 mm Sand 0,08 à 5 mm Gravel 5 à 80 mm Cobbles 80 à 300 mm Boulders > 300 mm	COHESIVE SOILS CONSISTENCY Very soft Soft Firm Stiff Very stiff Hard

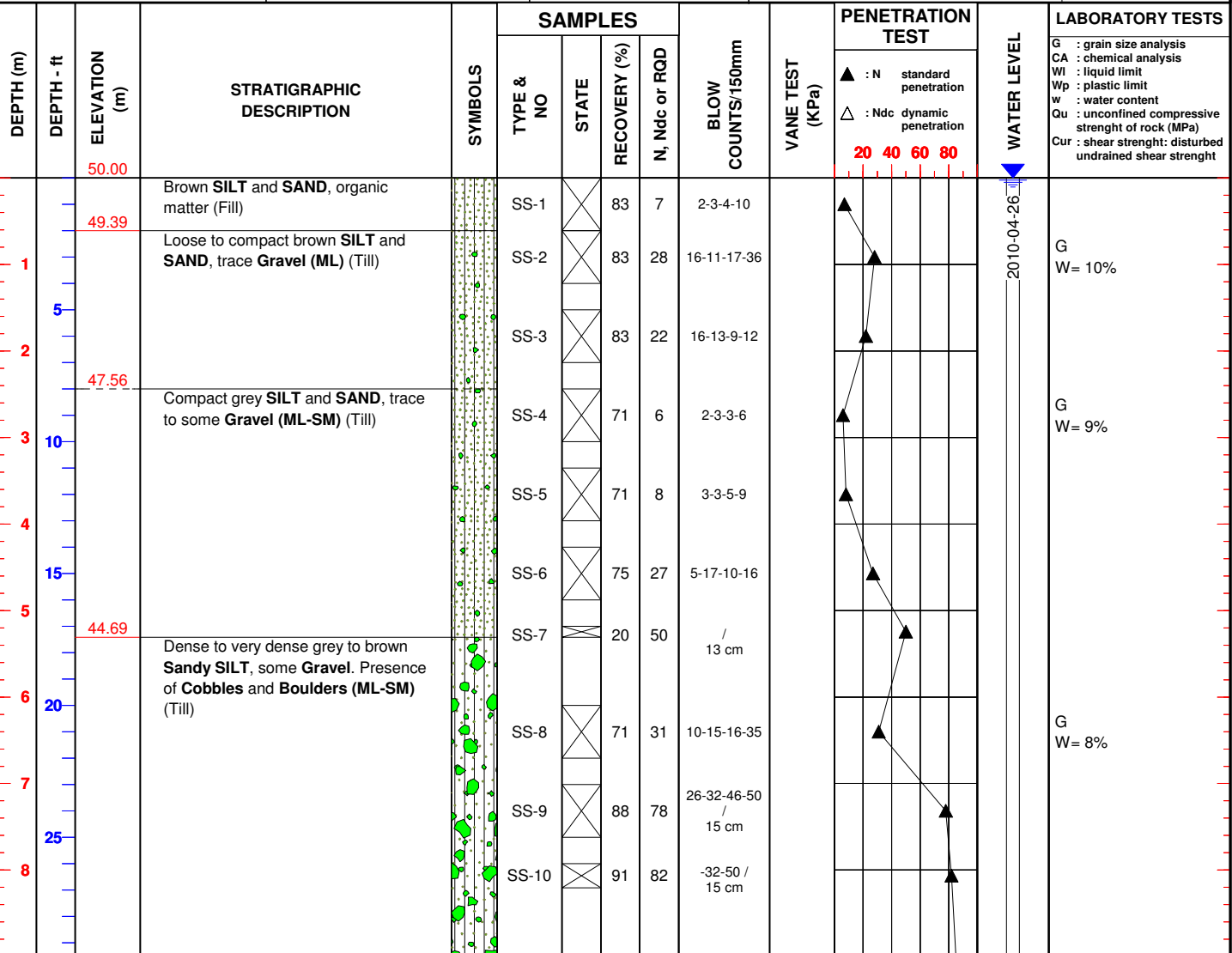

Remark(s):





DEPTH (m)	DEPTH - ft	ELEVATION (m)	STRATIGRAPHIC DESCRIPTION	SYMBOLS	SAMPLES				BLOW COUNTS/150mm	VANE TEST (KPa)	PENETRATION TEST				WATER LEVEL	LABORATORY TESTS
					TYPE & NO	STATE	RECOVERY (%)	N, Ndc or RGD			▲ : N standard penetration	△ : Ndc dynamic penetration	20	40		
10	35				SS-11	⊗	100	86	-36-50 / 10 cm							
11					SS-12	⊗	70	90	-40-50 / 10 cm							
12	40				SS-13	⊗	100	85	-35-50 / 13 cm							
13					SS-14	⊗	100	83	-33-50 / 13 cm							
14	45				SS-15	⊗	80	50	/ 10 cm							
15	50				SS-16	⊗	88	46	-16-30-50 / 13 cm							
16	55				SS-17	⊗	0	50	/ 8 cm							
17	60				SS-18	⊗	0	50	/ 5 cm							
18	65	30.82	BOULDERS		RC-19	⊗	42	31								
19																
20	21	29.12	END OF BOREHOLE													G W= 8%
21	70															
22																
23	75															
24																
25	80															







P:\Multi-Partage Groupe ABS(Geotec)\Fichier de style\LOG_GÉOTEC\Log_forage_ABS_Anglais_elevation.sty

Borehole N°
10BH-11

Project : **Wind Energy Converters (WEC)**
 Client : **TRANSALTA**
 Location : **Saint-Valentin, Québec**
 Drilling contractor : **Explora-sol inc.**
 Drilling type : **Casing**
 Diameter : **76,2 mm**
 Field technician : **Bernard Huppé, géo.**

O/F : **G1-09-1532**
 Geodesic coordinates (NAD-1983) X: **316592**
 Y: **4994528**
 Date of drilling : **2010-03-08**
 Drilling depth (m) : **15.62**

SOIL STATE  Disturbed  Intact  Lost  Core sample	TERMINOLOGY "traces" 1-10% "some" 10-20% adjective (sandy...) 20-35% "and" 35-50% SYMBOLS N N-value (Standard penetration test) R Refusal R.Q.D Rock Quality Designation % R.Q.D Σ Length of sound pieces > 100 mm Total core run length	ROCK QUALITY DESIGNATION % RQD QUALITATIVE <25 Very poor 25-50 Poor 50-75 Fair 75-90 Good 90-100 Excellent	COMPACTION INDEX "N" Very loose 0-4 Loose 4-10 Compact 10-30 Dense 30-50 Very dense >50	WATER LEVEL (m) Date: 2010-04-12 Date: Depth: 0.74 Depth:
TYPE OF SAMPLES SS Split Spoon ST Shelby tube HA Helical auger RC Roc core barrel CA Casing MA Manual	CLASSIFICATION Clay < 0,002 mm Silt 0,002 à 0,08 mm Sand 0,08 à 5 mm Gravel 5 à 80 mm Cobbles 80 à 300 mm Boulders > 300 mm		COHESIVE SOILS CONSISTENCY Very soft Soft Firm Stiff Very stiff Hard	SHEAR STRENGTH (Cu) <12 kPa 12-25 kPa 25-50 kPa 50-100 kPa 100-200 kPa >200 kPa

DEPTH (m)	DEPTH - ft	ELEVATION (m)	STRATIGRAPHIC DESCRIPTION	SYMBOLS	SAMPLES			BLOW COUNTS/150mm	VANE TEST (kPa)	PENETRATION TEST				WATER LEVEL	LABORATORY TESTS
					TYPE & NO	STATE	RECOVERY (%)			N _j Ndc or RQD	▲ : N standard penetration	△ : Ndc dynamic penetration	20		
		43.00	Stiff brown Silty CLAY , trace Sand and roots (ML)		SS-1	×	96	11	4-7-4-3						
1		41.78	Soft grey CLAY (CH)		SS-2	×	83	6	3-3-3-3						
2	5	40.56	Compact grey SILT , trace fine [Sand (ML)] "b" (Till)		SS-3	×	92	0	1-0-0-0	23					W = 74% W _p = 53% W _p = 25%
3	10				SS-4	×	75	4	1-0-4-7						
4	15				SS-5	×	79	11	6-6-5-7						G, w = 12%
5		38.12	Soft grey SILT , some Clay , trace Sand and Gravel (ML) (Till)		SS-6	×	75	9	4-4-5-5						
6	20	37.21	Loose grey SILT , trace to some Sand (ML) (Till)		SS-7	×	75	1	3-1-0-6						
7	25				SS-8	×	71	9	5-4-5-5						
8		34.77	Loose grey SILT (ML)		SS-9	×	71	10	4-5-5-5						
					SS-10	×	71	8	4-4-4-7						
					SS-11	×	75	8	3-3-5-3						G, w = 18%



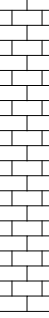

Remark(s):





DEPTH (m)	DEPTH - ft	ELEVATION (m)	STRATIGRAPHIC DESCRIPTION	SYMBOLS	SAMPLES			BLOW COUNTS/150mm	VANE TEST (KPa)	PENETRATION TEST				WATER LEVEL	LABORATORY TESTS
					TYPE & NO	STATE	RECOVERY (%)			N, Ndc or RGD	▲ : N standard penetration	△ : Ndc dynamic penetration	20		
10					SS-12	X	71	9	3-2-7-13						
35		32.33	Compact grey Sandy GRAVEL , some Silt and Cobbles (SP) (Till)		SS-13	X	21	25	19-15-10-15						G, w= 6%
12					SS-14	X	73		-12-50 / 13 cm						
40		30.53	Bedrock: Grey LIMESTONE , poor to excellent quality		RC-15	█	100	66							Qu= 117
13					RC-16	█	100	37							
14					RC-17	█	100	100							
15															
50		27.38	END OF BOREHOLE												
16															
55															
17															
18															
60															
19															
65															
20															
70															
21															
75															
22															
80															
23															
24															
80															
25															

Borehole N°
10BH-12

Project : **Wind Energy Converters (WEC)**
 Client : **TRANSALTA**
 Location : **Saint-Valentin, Québec**
 Drilling contractor : **Explora-sol inc.**
 Drilling type : **Casing**
 Diameter : **76,2 mm**
 Field technician : **Bernard Huppé, géo.**

O/F : **G1-09-1532**
 Geodesic coordinates (NAD-1983) X: **316596**
 Y: **4994055**
 Date of drilling : **2010-03-09**
 Drilling depth (m) : **17.83**

SOIL STATE  Disturbed  Intact  Lost  Core sample	TERMINOLOGY "traces" 1-10% "some" 10-20% adjective (sandy...) 20-35% "and" 35-50%	ROCK QUALITY DESIGNATION % RQD QUALITATIVE <25 Very poor 25-50 Poor 50-75 Fair 75-90 Good 90-100 Excellent	COMPACTION INDEX "N" Very loose 0-4 Loose 4-10 Compact 10-30 Dense 30-50 Very dense >50	WATER LEVEL (m) Date: 2010-04-12 Date: Depth: 1.00 Depth:
	TYPE OF SAMPLES SS Split Spoon ST Shelby tube HA Helical auger RC Roc core barrel CA Casing MA Manual	SYMBOLS N N-value (Standard penetration test) R Refusal R.Q.D Rock Quality Designation % R.Q.D Σ Length of sound pieces > 100 mm Total core run length	CLASSIFICATION Clay < 0,002 mm Silt 0,002 à 0,08 mm Sand 0,08 à 5 mm Gravel 5 à 80 mm Cobbles 80 à 300 mm Boulders > 300 mm	COHESIVE SOILS CONSISTENCY Very soft Soft Firm Stiff Very stiff Hard







DEPTH (m)	DEPTH - ft	ELEVATION (m)	STRATIGRAPHIC DESCRIPTION	SYMBOLS	SAMPLES				BLOW COUNTS/150mm	VANE TEST (kPa)	PENETRATION TEST				WATER LEVEL	LABORATORY TESTS
					TYPE & NO	STATE	RECOVERY (%)	N _j Ndc or RQD			20	40	60	80		
		42.13	Brown to grey SILT and SAND, some roots (SM) (Fill)		SS-1	X	58	6	5-5-1-2							
1		41.52	Soft grey CLAY (CH)		SS-2	X	58	2	1-1-1-2							
2	5				SS-3	X	100	0	1-0-0-0	21						
3	10	39.08	Compact grey SILT, trace fine Sand (ML) (Till)		SS-4	X	83	3	1-1-2-4							
4					SS-5	X	75	9	5-4-5-6							
5	15				SS-6	X	83	11	5-5-6-5							
6	20				SS-7	X	83	13	3-6-7-4							
7					SS-8	X	96	6	1-2-4-4							
8	25	34.81	Compact grey Gravelly Silty SAND, trace Cobbles (SM) (Till)		SS-9	X	52	14	10-4-10-50 / 8 cm							
					SS-10	X	4	22	7-10-12-16							G, w= 9%

Remark(s):

DEPTH (m)	DEPTH - ft	ELEVATION (m)	STRATIGRAPHIC DESCRIPTION	SYMBOLS	SAMPLES				BLOW COUNTS/150mm	VANE TEST (KPa)	PENETRATION TEST				WATER LEVEL	LABORATORY TESTS
					TYPE & NO	STATE	RECOVERY (%)	N, Ndc or RGD			▲ : N standard penetration	△ : Ndc dynamic penetration	20	40		
10					SS-11	X	0	21	12-11-10-14							
11	35				SS-12	X	63	13	5-4-9-13							
12					SS-13	X	82	25	15-11-14-50 / 10 cm							
13					SS-14	X	73	68	25-24-44-50 / 10 cm							
14	45	27.70	Bedrock: Grey LIMESTONE, good to excellent quality		RC-15	█	100	82								Qu= 90
15					RC-16	█	98	83								
16	50				RC-17	█	100	90								
17	55	24.29	END OF BOREHOLE													
18																
19	60															
20																
21	65															
22																
23	70															
24																
25	75															
	80															

Project : **Wind Energy Converters (WEC)**
 Client : **TRANSALTA**
 Location : **Saint-Valentin, Québec**
 Drilling contractor : **Explora-sol inc.**
 Drilling type : **Casing**
 Diameter : **76,2 mm**
 Field technician : **Bernard Huppé, géo.**
 Prepared by : Sébastien Veillette, dess.

O/F : **G1-09-1532**
 Geodesic coordinates (NAD-1983) X: **316618**
 Y: **4998175**
 Date of drilling : **2010-03-18**
 Drilling depth (m) : **30.48**

SOIL STATE  Disturbed  Intact  Lost  Core sample	TERMINOLOGY "traces" 1-10% "some" 10-20% adjective (sandy...) 20-35% "and" 35-50% SYMBOLS N N-value (Standard penetration test) R Refusal R.Q.D Rock Quality Designation % R.Q.D Σ Length of sound pieces > 100 mm Total core run length	ROCK QUALITY DESIGNATION % RQD QUALITATIVE <25 Very poor 25-50 Poor 50-75 Fair 75-90 Good 90-100 Excellent CLASSIFICATION Clay < 0,002 mm Silt 0,002 à 0,08 mm Sand 0,08 à 5 mm Gravel 5 à 80 mm Cobbles 80 à 300 mm Boulders > 300 mm	COMPACTION INDEX "N" Very loose 0-4 Loose 4-10 Compact 10-30 Dense 30-50 Very dense >50 COHESIVE SOILS CONSISTENCY Very soft Soft Firm Stiff Very stiff Hard	WATER LEVEL (m) Date: 2010-05-06 Date: Depth: 2.55 Depth:  Water infiltration  Groundwater table
---	---	---	--	---

DEPTH (m)	DEPTH - ft	ELEVATION (m)	STRATIGRAPHIC DESCRIPTION	SYMBOLS	SAMPLES			BLOW COUNTS/150mm	VANE TEST (kPa)	PENETRATION TEST				WATER LEVEL	LABORATORY TESTS
					TYPE & NO	STATE	RECOVERY (%)			N _j Ndc or RQD	▲ : N standard penetration	△ : Ndc dynamic penetration	20		
		47.92													
		47.31	Brown SAND, some Silt and organic matter		SS-1	×	71	7	1-2-5-7						
1			Compact brown Silty SAND, some Gravel (ML) (Till)		SS-2	×	100	30	9-12-18-27						
	5														
2		46.09	Loose grey Sandy SILT, trace to some Gravel (ML) (Till)		SS-3	×	92	19	10-10-9-11						
3					SS-4	×	83	10	8-5-5-10						
4					SS-5	×	79	11	3-4-7-7						G W= 10%
5					SS-6	×	88	4	1-2-2-5						
6					SS-7	×	46	4	1-2-2-5						
7					SS-8	×	58	5	1-2-3-5						
8					SS-9	×	75	7	3-3-4-7						G W= 13%
					SS-10	×	88	7	3-3-4-6						

Remark(s):

DEPTH (m)	DEPTH - ft	ELEVATION (m)	STRATIGRAPHIC DESCRIPTION	SYMBOLS	SAMPLES			BLOW COUNTS/150mm	VANE TEST (KPa)	PENETRATION TEST	WATER LEVEL	LABORATORY TESTS
					TYPE & NO	STATE	RECOVERY (%)					
10					SS-11	X	100	9	2-3-6-10	▲		
35		37.26	Compact grey SILT, trace Sand (ML) (Till)		SS-12	X	0	5	2-2-3-6	▲		
11					SS-13	X	0	19	6-9-10-13	▲		
12					SS-14	X	92	9	4-5-4-8	▲		
13			Compact grey Silty SAND, some Gravel (SM) (Till)		SS-15	X	33	50	/ 8 cm	▲		
45		34.21			SS-16	X	71	33	7-13-20-37	▲		
15			BOULDERS: Over consolidated till.		SS-17	X	50	50	/ 15 cm	▲		
17		30.25			RC-18		100	86				
18					RC-19		100	90				
19				RC-20		100	85					
20				RC-21		100	86					
21				RC-22		100	52					
22				RC-23		100	0					
23				RC-24		0	0					

▲ : N standard penetration
 △ : Ndc dynamic penetration
20 40 60 80

LABORATORY TESTS
 G : grain size analysis
 CA : chemical analysis
 Wl : liquid limit
 Wp : plastic limit
 w : water content
 Qu : unconfined compressive strength of rock (MPa)
 Cur : shear strength; disturbed undrained shear strength

G
W= 16%





P:\Multi-Partage Groupe ABS\Géotec\Fichier de style\LOG_GÉOTEC\Log_forage_ABS_Anglais_elevation.sty

DEPTH (m)	DEPTH - ft	ELEVATION (m)	STRATIGRAPHIC DESCRIPTION	SYMBOLS	SAMPLES			BLOW COUNTS/150mm	VANE TEST (KPa)	PENETRATION TEST				WATER LEVEL	LABORATORY TESTS	
					TYPE & NO	STATE	RECOVERY (%)			N, Ndc or RQD	▲ : N standard penetration	△ : Ndc dynamic penetration	20			40
26	85				RC-25		100	79								
27	90				RC-26		100	56								
29	95				RC-27		100	91								
30	100	17.44	END OF BOREHOLE													
31																
32	105															
33																
34	110															
35	115															
36	120															
37																
38	125															
39																
40	130															
41	135															

Borehole N° 10BH-14

Project : **Wind Energy Converters (WEC)**
 Client : **TRANSALTA**
 Location : **Saint-Valentin, Québec**
 Drilling contractor : **Explora-sol inc.**
 Drilling type : **Casing**
 Diameter : **76,2 mm**
 Field technician : **Bernard Huppé, géo.**

O/F : **G1-09-1532**
 Geodesic coordinates (NAD-1983) X: **316620**
 Y: **4994936**
 Date of drilling : **2010-03-12**
 Drilling depth (m) : **16.10**

SOIL STATE  Disturbed  Intact  Lost  Core sample	TERMINOLOGY "traces" 1-10% "some" 10-20% adjective (sandy...) 20-35% "and" 35-50% SYMBOLS N N-value (Standard penetration test) R Refusal R.Q.D Rock Quality Designation % R.Q.D Σ Length of sound pieces > 100 mm Total core run length	ROCK QUALITY DESIGNATION % RQD QUALITATIVE <25 Very poor 25-50 Poor 50-75 Fair 75-90 Good 90-100 Excellent	COMPACTION INDEX "N" Very loose 0-4 Loose 4-10 Compact 10-30 Dense 30-50 Very dense >50	WATER LEVEL (m) Date: 2010-04-12 Date: Depth: 1.13 Depth:
TYPE OF SAMPLES SS Split Spoon ST Shelby tube HA Helical auger RC Roc core barrel CA Casing MA Manual	CLASSIFICATION Clay < 0,002 mm Silt 0,002 à 0,08 mm Sand 0,08 à 5 mm Gravel 5 à 80 mm Cobbles 80 à 300 mm Boulders > 300 mm		COHESIVE SOILS CONSISTENCY Very soft Soft Firm Stiff Very stiff Hard	SHEAR STRENGTH (Cu) <12 kPa 12-25 kPa 25-50 kPa 50-100 kPa 100-200 kPa >200 kPa

DEPTH (m)	DEPTH - ft	ELEVATION (m)	STRATIGRAPHIC DESCRIPTION	SYMBOLS	SAMPLES			BLOW COUNTS/150mm	VANE TEST (kPa)	PENETRATION TEST	WATER LEVEL	LABORATORY TESTS
					TYPE & NO	STATE	RECOVERY (%)					
		44.00	Brown SAND, trace Silt (SP) (Fill)									
1					SS-1	X	71	6	2-2-4-6	▲		
					SS-2	X	83	10	4-4-6-4	▲		
5		42.48	Compact to dense grey medium to fine SAND, trace to some Gravel (SP)		SS-3	X	83	2	1-1-1-12	▲		
2					SS-4	X	75	35	12-16-19-24	▲		
3					SS-5	X	75	29	10-12-17-22	▲		
4					SS-6	X	67	22	5-10-12-17	▲		
5					SS-7	X	75	26	9-12-14-18	▲		
6					SS-8	X	0	29	12-13-16-18	▲		
7					SS-9	X	54	15	8-6-9-12	▲		
8			Increasing gravel content with depth		SS-10	X	21	19	10-8-11-14	▲		
		35.47	Dense grey GRAVEL and SAND (GP)		SS-11	X	8	28	9-15-13-13	▲		

Remark(s):

DEPTH (m)	DEPTH - ft	ELEVATION (m)	STRATIGRAPHIC DESCRIPTION	SYMBOLS	SAMPLES				BLOW COUNTS/150mm	VANE TEST (KPa)	PENETRATION TEST				WATER LEVEL	LABORATORY TESTS
					TYPE & NO	STATE	RECOVERY (%)	N, Ndc or RQD			▲ : N standard penetration	△ : Ndc dynamic penetration	20	40		
10	35				SS-12	X	4	33	15-15-18-23		▲					G W= 10%
11					SS-13	X	21	37	16-17-20-24		▲					
12	40				SS-14	X	29	21	8-8-13-10		▲					
13	45	31.20	Bedrock: Grey LIMESTONE , excellent quality		RC-15	█	100	100								Qu= 105
14					RC-16	█	100	100								
15	50				RC-17	█	100	94								
16	55	27.90	END OF BOREHOLE													
17	60															
18	65															
19	70															
20	75															
21	80															
22																
23																
24																
25																

Project : **Wind Energy Converters (WEC)**
 Client : **TRANSALTA**
 Location : **Saint-Valentin, Québec**
 Drilling contractor : **Explora-sol inc.**
 Drilling type : **Casing**
 Diameter : **76,2 mm**
 Field technician : **Karim Boudalia, géo.**

O/F : **G1-09-1532**
 Geodesic coordinates (NAD-1983) X: **316876**
 Y: **5001955**
 Date of drilling : **2010-03-29**
 Drilling depth (m) : **12.09**

SOIL STATE Disturbed Intact Lost Core sample	TERMINOLOGY "traces" 1-10% "some" 10-20% adjective (sandy...) 20-35% "and" 35-50% SYMBOLS N N-value (Standard penetration test) R Refusal R.Q.D Rock Quality Designation % R.Q.D Σ Length of sound pieces > 100 mm Total core run length	ROCK QUALITY DESIGNATION % RQD QUALITATIVE <25 Very poor 25-50 Poor 50-75 Fair 75-90 Good 90-100 Excellent	COMPACTION INDEX "N" Very loose 0-4 Loose 4-10 Compact 10-30 Dense 30-50 Very dense >50	WATER LEVEL (m) Date: 2010-04-26 Date: Depth: 1.45 Depth:
TYPE OF SAMPLES SS Split Spoon ST Shelby tube HA Helical auger RC Roc core barrel CA Casing MA Manual	CLASSIFICATION Clay < 0,002 mm Silt 0,002 à 0,08 mm Sand 0,08 à 5 mm Gravel 5 à 80 mm Cobbles 80 à 300 mm Boulders > 300 mm	COHESIVE SOILS CONSISTENCY Very soft Soft Firm Stiff Very stiff Hard	SHEAR STRENGTH (Cu) <12 kPa 12-25 kPa 25-50 kPa 50-100 kPa 100-200 kPa >200 kPa	Water infiltration Groundwater table

DEPTH (m)	DEPTH - ft	ELEVATION (m)	STRATIGRAPHIC DESCRIPTION	SYMBOLS	SAMPLES			BLOW COUNTS/150mm	VANE TEST (kPa)	PENETRATION TEST				WATER LEVEL	LABORATORY TESTS
					TYPE & NO	STATE	RECOVERY (%)			N _j Ndc or RQD	20	40	60		
		51.00	Brown Sandy SILT , some Gravel , organic matters and roots (Fill)		SS-1	X	75	4	1-2-2-5						
1					SS-2	X	75	24	11-11-13-14						
	5	49.48	Dense brown SILT and SAND , trace of Gravel (ML-SM) (Till)		SS-3	X	96	55	11-16-39-31						G W= 11%
2					SS-4	X	71	16	5-7-9-17						
	10	48.56	Compact to loose grey SILT and SAND , trace to some Gravel . Presence of Cobbles (ML-SM) (Till)		SS-5	X	63	24	13-11-13-11						
3					SS-6	X	71	13	6-6-7-9						
4					SS-7	X	0	9	5-3-6-6						
5	15				SS-8	X	67	5	4-1-4-5						G W= 9%
6					SS-9	X	8	9	4-3-6-17						
7					SS-10	X	11	61	-11-50 / 8 cm						
8	25														
		42.09													

Remark(s):

DEPTH (m)	DEPTH - ft	ELEVATION (m)	STRATIGRAPHIC DESCRIPTION	SYMBOLS	SAMPLES			BLOW COUNTS/150mm	VANE TEST (KPa)	PENETRATION TEST				WATER LEVEL	LABORATORY TESTS
					TYPE & NO	STATE	RECOVERY (%)			N, Ndc or RQD	▲ : N standard penetration	△ : Ndc dynamic penetration	20		
			Bedrock: Black LIMESTONE, good quality	[Brick Pattern]	SS-11		0	50	-50 / 8 cm						
10					RC-12		97	86							
11	35				RC-13		97	90							
12		38.91	END OF BOREHOLE												Qu= 55
13															
14	45														
15															
16	50														
17															
18	55														
19															
20	60														
21															
22	65														
23															
24	70														
25															
	75														
	80														
	85														
	90														
	95														
	100														

Project : **Wind Energy Converters (WEC)**
 Client : **TRANSALTA**
 Location : **Saint-Valentin, Québec**
 Drilling contractor : **Explora-sol inc.**
 Drilling type : **Casing**
 Diameter : **76,2 mm**
 Field technician : **Rock Samson, tech.**

O/F : **G1-09-1532**
 Geodesic coordinates (NAD-1983) X: **317102**
 Y: **5001353**
 Date of drilling : **2010-03-25**
 Drilling depth (m) : **19.94**

SOIL STATE Disturbed Intact Lost Core sample	TERMINOLOGY "traces" 1-10% "some" 10-20% adjective (sandy...) 20-35% "and" 35-50% SYMBOLS N N-value (Standard penetration test) R Refusal R.Q.D Rock Quality Designation % R.Q.D Σ Length of sound pieces > 100 mm Total core run length	ROCK QUALITY DESIGNATION % RQD QUALITATIVE <25 Very poor 25-50 Poor 50-75 Fair 75-90 Good 90-100 Excellent CLASSIFICATION Clay < 0,002 mm Silt 0,002 à 0,08 mm Sand 0,08 à 5 mm Gravel 5 à 80 mm Cobbles 80 à 300 mm Boulders > 300 mm	COMPACTION INDEX "N" Very loose 0-4 Loose 4-10 Compact 10-30 Dense 30-50 Very dense >50 COHESIVE SOILS CONSISTENCY Very soft Soft Firm Stiff Very stiff Hard	WATER LEVEL (m) Date: 2010-04-26 Date: Depth: 0.75 Depth: Water infiltration Groundwater table
TYPE OF SAMPLES SS Split Spoon ST Shelby tube HA Helical auger RC Roc core barrel CA Casing MA Manual				SHEAR STRENGTH (Cu) <12 kPa 12-25 kPa 25-50 kPa 50-100 kPa 100-200 kPa >200 kPa

P:\Multi-Partage Groupe ABS\Géotec\Fichier de style\LOG_GÉOTEC\Log_forage_ABS_Anglais_elevation.sty

DEPTH (m)	DEPTH - ft	ELEVATION (m)	STRATIGRAPHIC DESCRIPTION	SYMBOLS	SAMPLES			BLOW COUNTS/150mm	VANE TEST (kPa)	PENETRATION TEST	WATER LEVEL	LABORATORY TESTS
					TYPE & NO	STATE	RECOVERY (%)					
		50.00	Brown Silty SAND (Fill)		SS-1	X	0	8	2-4-4-8	▲		
1		49.26	Soft grey Silty CLAY (CL)		SS-2	X	67	3	3-1-2-3	▲		
2	5				SS-3	X	75	1	1-0-1-0	▲		
3	10				SS-4	X	46	1	1-0-1-2	▲		
4		46.65	Loose to compact grey SILT and SAND, trace Gravel (ML-SM) (Till)		SS-5	X	63	9	1-4-5-7	▲		W = 52% Wl = 28% Wp = 13%
5	15				SS-6	X	42	23	6-11-12-15	▲		
6	20				SS-7	X	83	4	1-2-2-3	▲		G W = 10%
7					SS-8	X	50	6	2-3-3-4	▲		
8	25				SS-9	X	50	20	2-5-15-14	▲		
		42.08	Compact grey SILT and SAND, trace Gravel (ML-SM) (Till)		SS-10	X	75	29	10-15-14-10	▲		G W = 9%

Remark(s):

DEPTH (m)	DEPTH - ft	ELEVATION (m)	STRATIGRAPHIC DESCRIPTION	SYMBOLS	SAMPLES				BLOW COUNTS/150mm	VANE TEST (KPa)	PENETRATION TEST				WATER LEVEL	LABORATORY TESTS
					TYPE & NO	STATE	RECOVERY (%)	N, Ndc or RGD			▲ : N standard penetration	△ : Ndc dynamic penetration	20	40		
		40.25	Very dense grey Sandy SILT , trace Gravel . Presence Cobbles (ML) (Till)		SS-11		100	50	-50 / 10 cm						G W= 9%	
10	35			SS-12	⊗	100	73	-35-38-50 / 10 cm								
11				SS-13	⊗	100	84	-34-50 / 25 cm								
12	40			SS-14	⊗	50	67	-27-40-50 / 10 cm								
13				SS-15	⊗	100	50	/ 10 cm								
14	45			SS-16	⊗	100	90	-40-50 / 13 cm								
15				SS-17	⊗	80	50	/ 13 cm								
16	50			SS-18	⊗	25	50	/ 10 cm								
17	55			SS-19	⊗	100	50	/ 13 cm								
18	60			SS-20	⊗	13	50	/ 13 cm								
19			BOULDERS and COBBLES END OF BOREHOLE		RC-21	■										
20	65	30.06														
21	70															
22																
23	75															
24																
25	80															

P:\Multi-Partage Groupe ABS\Géotec\Fichier de style\LOG_GÉOTEC\Log_forage_ABS_Anglais_elevation.sty

Borehole N°
10BH-18

Project : **Wind Energy Converters (WEC)**
 Client : **TRANSALTA**
 Location : **Saint-Valentin, Québec**
 Drilling contractor : **Explora-sol inc.**
 Drilling type : **Casing**
 Diameter : **76,2 mm**
 Field technician : **Karim Boudalia, géo.**

O/F : **G1-09-1532**
 Geodesic coordinates (NAD-1983) X: **317273**
 Y: **5002650**
 Date of drilling : **2010-04-02**
 Drilling depth (m) : **9.58**

SOIL STATE Disturbed Intact Lost Core sample	TERMINOLOGY "traces" 1-10% "some" 10-20% adjective (sandy...) 20-35% "and" 35-50%	ROCK QUALITY DESIGNATION % RQD QUALITATIVE <25 Very poor 25-50 Poor 50-75 Fair 75-90 Good 90-100 Excellent	COMPACTION INDEX "N" Very loose 0-4 Loose 4-10 Compact 10-30 Dense 30-50 Very dense >50	WATER LEVEL (m) Date: 2010-04-26 Date: Depth: 0.00 Depth:
	SYMBOLS N N-value (Standard penetration test) R Refusal R.Q.D Rock Quality Designation % R.Q.D Σ Length of sound pieces > 100 mm Total core run length	CLASSIFICATION Clay < 0,002 mm Silt 0,002 à 0,08 mm Sand 0,08 à 5 mm Gravel 5 à 80 mm Cobbles 80 à 300 mm Boulders > 300 mm	COHESIVE SOILS CONSISTENCY Very soft Soft Firm Stiff Very stiff Hard	SHEAR STRENGTH (Cu) <12 kPa 12-25 kPa 25-50 kPa 50-100 kPa 100-200 kPa >200 kPa





DEPTH (m)	DEPTH - ft	ELEVATION (m)	STRATIGRAPHIC DESCRIPTION	SYMBOLS	SAMPLES			BLOW COUNTS/150mm	VANE TEST (kPa)	PENETRATION TEST				WATER LEVEL	LABORATORY TESTS
					TYPE & NO	STATE	RECOVERY (%)			N _j Ndc or RQD	▲ : N standard penetration	△ : Ndc dynamic penetration	20		
		50.00 49.80	Black top soil												
1	5		Compact to loose brown SILT and SAND, trace to some Gravel (ML-SM) (Till)		SS-1	X	92	5	2-2-3-8						
					SS-2	X	100	24	7-10-14-14					G W= 10%	
2					SS-3	X	0	9	6-5-4-8						
3	10	46.65	Very dense grey SILT and SAND, trace to some Gravel (ML) (Till)		SS-4	X	4	5	2-2-3-4						
4					SS-5	X	63	67	44-37-30-50 / 8 cm					G W= 10%	
5	15				SS-6	X	91	98	-48-50 / 13 cm						
6	20	43.95	Gravelly		SS-7	X	60	69	15-32-37-50 / 10 cm					G W= 7%	
7			Bedrock: Grey LIMESTONE, fractured on surface, good quality		RC-8		57	0							
					RC-9		86	78						Qu= 68	
8	25				RC-10		96	88							

Remark(s):

DEPTH (m)	DEPTH - ft	ELEVATION (m)	STRATIGRAPHIC DESCRIPTION	SYMBOLS	SAMPLES				BLOW COUNTS/150mm	VANE TEST (KPa)	PENETRATION TEST				WATER LEVEL	LABORATORY TESTS
					TYPE & NO	STATE	RECOVERY (%)	N, Ndc or RQD			▲ : N standard penetration	△ : Ndc dynamic penetration	20	40		
		40.42	END OF BOREHOLE													
10																
	35															
11																
12																
	40															
13																
14																
	45															
15																
16																
	50															
17																
18																
19																
	55															
20																
21																
	60															
22																
23																
	65															
24																
25																
	70															
	75															
	80															

Project : **Wind Energy Converters (WEC)**
 Client : **TRANSALTA**
 Location : **Saint-Valentin, Québec**
 Drilling contractor : **Explora-sol inc.**
 Drilling type : **Casing**
 Diameter : **76,2 mm**
 Field technician : **Karim Boudalia, géo.**

O/F : **G1-09-1532**
 Geodesic coordinates (NAD-1983) X: **317482**
 Y: **5002277**
 Date of drilling : **2010-04-02**
 Drilling depth (m) : **20.17**

SOIL STATE  Disturbed  Intact  Lost  Core sample	TERMINOLOGY "traces" 1-10% "some" 10-20% adjective (sandy...) 20-35% "and" 35-50%	ROCK QUALITY DESIGNATION % RQD QUALITATIVE <25 Very poor 25-50 Poor 50-75 Fair 75-90 Good 90-100 Excellent	COMPACTION INDEX "N" Very loose 0-4 Loose 4-10 Compact 10-30 Dense 30-50 Very dense >50	WATER LEVEL (m) Date: 2010-04-26 Date: Depth: 0.00 Depth:
	TYPE OF SAMPLES SS Split Spoon ST Shelby tube HA Helical auger RC Roc core barrel CA Casing MA Manual	SYMBOLS N N-value (Standard penetration test) R Refusal R.Q.D Rock Quality Designation % R.Q.D Σ Length of sound pieces > 100 mm Total core run length	CLASSIFICATION Clay < 0,002 mm Silt 0,002 à 0,08 mm Sand 0,08 à 5 mm Gravel 5 à 80 mm Cobbles 80 à 300 mm Boulders > 300 mm	COHESIVE SOILS CONSISTENCY Very soft Soft Firm Stiff Very stiff Hard

DEPTH (m)	DEPTH - ft	ELEVATION (m)	STRATIGRAPHIC DESCRIPTION	SYMBOLS	SAMPLES			BLOW COUNTS/150mm	VANE TEST (kPa)	PENETRATION TEST				WATER LEVEL	LABORATORY TESTS
					TYPE & NO	STATE	RECOVERY (%)			N _d Ndc or RQD	▲ : N standard penetration	△ : Ndc dynamic penetration	20		
		49.00	Top soil.												
		48.39	Grey SAND and CLAY. Presence of pieces of wood (Fill)		SS-1	×	58	3	1-2-1-2	▲					
1					SS-2	×	17	3	2-1-2-1	▲					
	5	47.17	Loose to compact grey SILT and SAND, trace of Gravel to Gravelly (ML) (Till)		SS-3	×	17	5	1-2-3-2	▲					
2					SS-4	×	63	5	1-2-3-4	▲					G W= 12%
3	10				SS-5	×	33	13	1-3-10-4	▲					
4					SS-6	×	33	4	1-2-2-3	▲					
5	15				SS-7	×	13	5	1-2-3-5	▲					G W= 7%
6	20				SS-8	×	88	7	3-3-4-6	▲					
7					SS-9	×	0	11	3-6-5-8	▲					
8	25	41.08	Dense to very dense grey Sandy SILT, some Gravel (ML) (Till)		SS-10	×	63	75	32-45-30-25	▲					G W= 15%







Remark(s):

DEPTH (m)	DEPTH - ft	ELEVATION (m)	STRATIGRAPHIC DESCRIPTION	SYMBOLS	SAMPLES				BLOW COUNTS/150mm	VANE TEST (KPa)	PENETRATION TEST				WATER LEVEL	LABORATORY TESTS
					TYPE & NO	STATE	RECOVERY (%)	N, Ndc or RQD			▲ : N standard penetration	△ : Ndc dynamic penetration	20	40		
10		39.25	Zone of COBBLES and BOULDERS		SS-11	X	63	39	17-25-14-15		▲					
11																
12		36.81	Compact to very dense Gravelly SAND , trace of Silt . Presence of Cobbles and Boulders (SP)		SS-12	X	50	11	7-6-5-11		▲					
13																
14					SS-13	X	100	65	-15-50 / 10 cm							
15																
16		32.74	BOULDERS.		SS-14	X	100	50	/ 13 cm							
17					RC-15		37	0								
18					RC-16		32	0								
19																
20		28.83	END OF BOREHOLE		RC-17		34	0								
21																
22																
23																
24																
25																

P:\Multi-Partage Groupe ABS(Géotec)\Fichier de style\LOG_GÉOTEC\Log_forage_ABS_Anglais_elevation.sty

Project : **Wind Energy Converters (WEC)**
 Client : **TRANSALTA**
 Location : **Saint-Valentin, Québec**
 Drilling contractor : **Explora-sol inc.**
 Drilling type : **Casing**
 Diameter : **76,2 mm**
 Field technician : **Karim Boudalia, géo.**

O/F : **G1-09-1532**
 Geodesic coordinates (NAD-1983) X: **318008**
 Y: **5002258**
 Date of drilling : **2010-04-07**
 Drilling depth (m) : **14.33**

SOIL STATE  Disturbed  Intact  Lost  Core sample	TERMINOLOGY "traces" 1-10% "some" 10-20% adjective (sandy...) 20-35% "and" 35-50% SYMBOLS N N-value (Standard penetration test) R Refusal R.Q.D Rock Quality Designation % R.Q.D Σ Length of sound pieces > 100 mm Total core run length	ROCK QUALITY DESIGNATION % RQD QUALITATIVE <25 Very poor 25-50 Poor 50-75 Fair 75-90 Good 90-100 Excellent	COMPACTION INDEX "N" Very loose 0-4 Loose 4-10 Compact 10-30 Dense 30-50 Very dense >50	WATER LEVEL (m) Date: 2010-04-26 Date: Depth: 0.51 Depth:	
TYPE OF SAMPLES SS Split Spoon ST Shelby tube HA Helical auger RC Roc core barrel CA Casing MA Manual	CLASSIFICATION Clay < 0,002 mm Silt 0,002 à 0,08 mm Sand 0,08 à 5 mm Gravel 5 à 80 mm Cobbles 80 à 300 mm Boulders > 300 mm		COHESIVE SOILS CONSISTENCY Very soft Soft Firm Stiff Very stiff Hard	SHEAR STRENGTH (Cu) <12 kPa 12-25 kPa 25-50 kPa 50-100 kPa 100-200 kPa >200 kPa	 Water infiltration  Groundwater table







DEPTH (m)	DEPTH - ft	ELEVATION (m)	STRATIGRAPHIC DESCRIPTION	SYMBOLS	SAMPLES			BLOW COUNTS/150mm	VANE TEST (kPa)	PENETRATION TEST				WATER LEVEL	LABORATORY TESTS
					TYPE & NO	STATE	RECOVERY (%)			N _j Ndc or RQD	▲ : N standard penetration	△ : Ndc dynamic penetration	20		
		48.00	Top soil												
		47.49	Grey SAND, some Silt (SM)		SS-1	⊗	75	1	0-0-1-2						
1		47.14	Soft grey CLAY, trace of Silt (CL)		SS-2	⊗	50	5	3-3-2-1						
	5	46.17	Loose grey SILT, some Sand (ML) (Till)		SS-3	⊗	96	3	0-1-2-1						
2					SS-4	⊗	8	7	5-4-3-2						
3	10	44.65	Loose to compact grey SILT and SAND, trace Gravel and Clay. Presence of Cobbles (ML) (Till)		SS-5	⊗	33	4	2-2-2-3						G W= 14%
4					SS-6	⊗	29	11	2-5-6-4						
5	15				SS-7	⊗	83	5	1-2-3-3						G W= 11%
6	20				SS-8	⊗	4	4	2-2-2-3						
7					SS-9	⊗	0	25	5-13-12-3						
8	25				SS-10	⊗	96	4	0-1-3-6						G W= 13%
			Becomes Gravelly												

Remark(s):

DEPTH (m)	DEPTH - ft	ELEVATION (m)	STRATIGRAPHIC DESCRIPTION	SYMBOLS	SAMPLES				BLOW COUNTS/150mm	VANE TEST (KPa)	PENETRATION TEST				WATER LEVEL	LABORATORY TESTS
					TYPE & NO	STATE	RECOVERY (%)	N, Ndc or RQD			▲ : N standard penetration	△ : Ndc dynamic penetration	20	40		
10					SS-11	⊗	29	25	8-13-12-20		▲					G : grain size analysis CA : chemical analysis Wl : liquid limit Wp : plastic limit w : water content Qu : unconfined compressive strength of rock (MPa) Cur : shear strength; disturbed undrained shear strength G W = 10% Qu = 79
11		36.82	Bedrock: Black and grey LIMESTONE , excellent quality		SS-12	⊗	92	65	-23-42-50 / 3 cm		▲					
12					RC-13		90	93								
14		33.67			RC-14		98	95								
15			END OF BOREHOLE													
16																
17																
18																
19																
20																
21																
22																
23																
24																
25																

Project : **Wind Energy Converters (WEC)**
 Client : **TRANSALTA**
 Location : **Saint-Valentin, Québec**
 Drilling contractor : **Explora-sol inc.**
 Drilling type : **Casing**
 Diameter : **76,2 mm**
 Field technician : **Karim Boudalia, géo.**

O/F : **G1-09-1532**
 Geodesic coordinates (NAD-1983) X: **318187**
 Y: **5001293**
 Date of drilling : **2010-04-13**
 Drilling depth (m) : **16.26**

SOIL STATE  Disturbed  Intact  Lost  Core sample	TERMINOLOGY "traces" 1-10% "some" 10-20% adjective (sandy...) 20-35% "and" 35-50% SYMBOLS N N-value (Standard penetration test) R Refusal R.Q.D Rock Quality Designation % R.Q.D Σ Length of sound pieces > 100 mm Total core run length	ROCK QUALITY DESIGNATION % RQD QUALITATIVE <25 Very poor 25-50 Poor 50-75 Fair 75-90 Good 90-100 Excellent	COMPACTION INDEX "N" Very loose 0-4 Loose 4-10 Compact 10-30 Dense 30-50 Very dense >50	WATER LEVEL (m) Date: 2010-04-26 Date: Depth: 0.80 Depth:
TYPE OF SAMPLES SS Split Spoon ST Shelby tube HA Helical auger RC Roc core barrel CA Casing MA Manual	CLASSIFICATION Clay < 0,002 mm Silt 0,002 à 0,08 mm Sand 0,08 à 5 mm Gravel 5 à 80 mm Cobbles 80 à 300 mm Boulders > 300 mm	COHESIVE SOILS CONSISTENCY Very soft Soft Firm Stiff Very stiff Hard	SHEAR STRENGTH (Cu) <12 kPa 12-25 kPa 25-50 kPa 50-100 kPa 100-200 kPa >200 kPa	 Water infiltration  Groundwater table

DEPTH (m)	DEPTH - ft	ELEVATION (m)	STRATIGRAPHIC DESCRIPTION	SYMBOLS	SAMPLES			BLOW COUNTS/150mm	VANE TEST (kPa)	PENETRATION TEST				WATER LEVEL	LABORATORY TESTS
					TYPE & NO	STATE	RECOVERY (%)			N _j Ndc or RQD	▲ : N standard penetration	△ : Ndc dynamic penetration	20		
		46.00	Topsoil												
		45.75	Compact brown Sandy SILT , trace Gravel (ML) (Till)		SS-1	×	63	6	2-3-3-6						
1					SS-2	×	100	17	8-8-9-15						G W = 12%
2	5				SS-3	×	67	14	7-6-8-9						
3	10	43.56	Loose to compact grey Sandy SILT , trace Gravel (ML) (Till)		SS-4	×	79	5	1-2-3-6						G W = 15%
4		42.24	Very dense grey GRAVEL and SAND , some Silt . Presence of Cobbles (GM) (Till)		SS-5	×	63	23	-6-17-50 /10 cm						
5	15				SS-6	×	0	58	27-23-35-46						
6	20				SS-7	×	0		-47-50 /8 cm						
7					SS-8	×	50	62	33-39-23-21						G W = 6%
8	25				SS-9	×	9		-21-50 /13 cm						
		37.82	COBBLES and BOULDERS		SS-10	×	80		-33-50 /10 cm						
					RC-11	█	38								

Remark(s):

DEPTH (m)	DEPTH - ft	ELEVATION (m)	STRATIGRAPHIC DESCRIPTION	SYMBOLS	SAMPLES				BLOW COUNTS/150mm	VANE TEST (KPa)	PENETRATION TEST				WATER LEVEL	LABORATORY TESTS
					TYPE & NO	STATE	RECOVERY (%)	N, Ndc or RGD			▲ : N standard penetration	△ : Ndc dynamic penetration	20	40		
					SS-12		67	-50 / 8 cm								
10					RC-13		42									
	35				RC-14		5									
11					RC-15		62									
12					RC-16		57									
		33.05	Bedrock: Black LIMESTONE, good quality		RC-17		97	88								
14					RC-18		97	84								
15					RC-19		83	75								
		29.74	END OF BOREHOLE													
17																
18																
19																
20																
21																
22																
23																
24																
25																







P:\Multi-Partage Groupe ABS(Geotec)\Fichier de style\LOG_GÉOTEC\Log_forage_ABS_Anglais_elevation.sty

Qu= 123

Project : **Wind Energy Converters (WEC)**
 Client : **TRANSALTA**
 Location : **Saint-Valentin, Québec**
 Drilling contractor : **Explora-sol inc.**
 Drilling type : **Casing**
 Diameter : **76,2 mm**
 Field technician : **Rock Samson, tech.**



O/F : **G1-09-1532**
 Geodesic coordinates (NAD-1983) X: **318195**
 Y: **5001745**
 Date of drilling : **2010-04-13**
 Drilling depth (m) : **13.72**

Prepared by : Sébastien Veillette, dess.

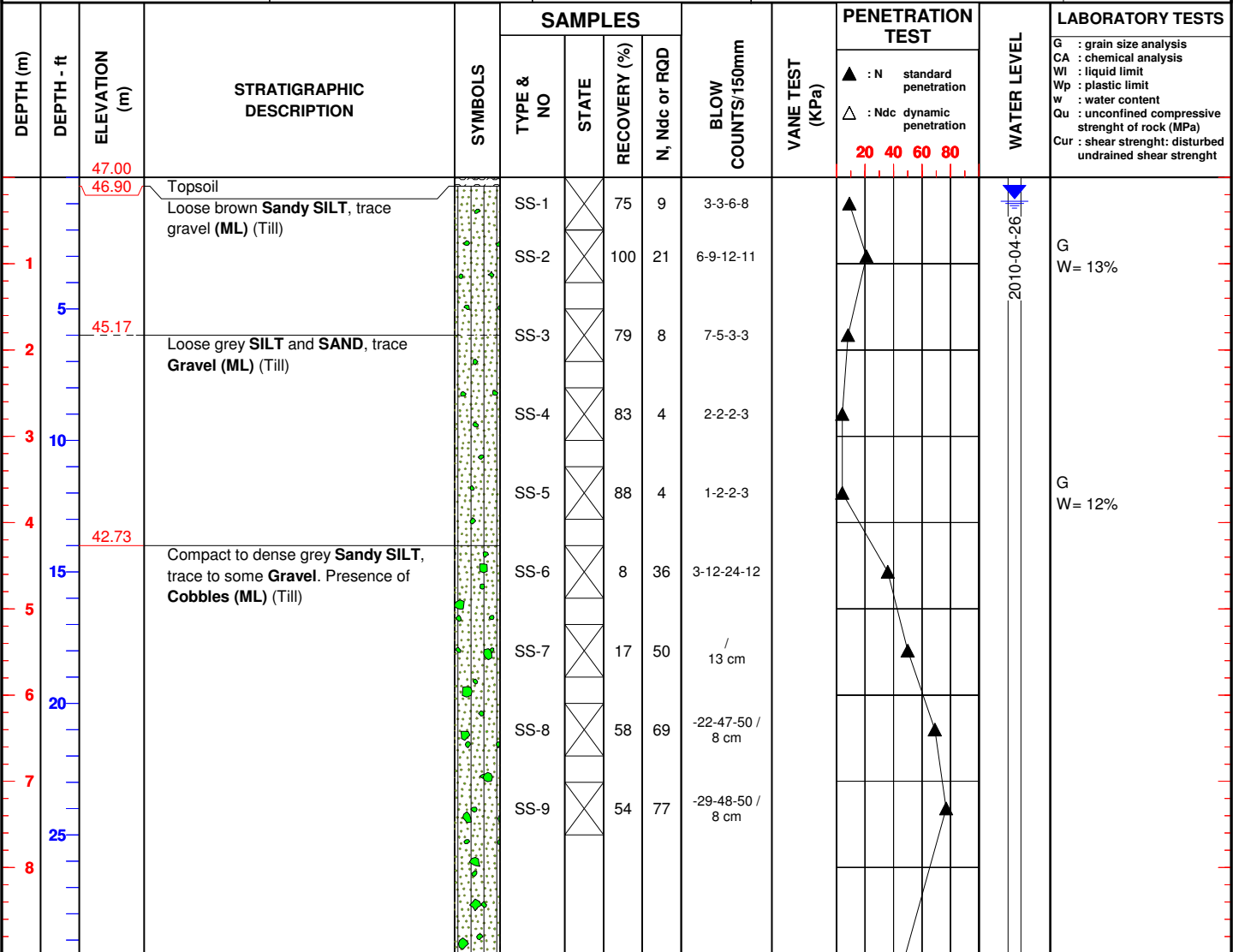
SOIL STATE  Disturbed  Intact  Lost  Core sample	TERMINOLOGY "traces" 1-10% "some" 10-20% adjective (sandy...) 20-35% "and" 35-50% SYMBOLS N N-value (Standard penetration test) R Refusal R.Q.D Rock Quality Designation % R.Q.D Σ Length of sound pieces > 100 mm Total core run length	ROCK QUALITY DESIGNATION % RQD QUALITATIVE <25 Very poor 25-50 Poor 50-75 Fair 75-90 Good 90-100 Excellent	COMPACTION INDEX "N" Very loose 0-4 Loose 4-10 Compact 10-30 Dense 30-50 Very dense >50	WATER LEVEL (m) Date: 2010-04-26 Date: Depth: 0.25 Depth:	
TYPE OF SAMPLES SS Split Spoon ST Shelby tube HA Helical auger RC Roc core barrel CA Casing MA Manual	CLASSIFICATION Clay < 0,002 mm Silt 0,002 à 0,08 mm Sand 0,08 à 5 mm Gravel 5 à 80 mm Cobbles 80 à 300 mm Boulders > 300 mm		COHESIVE SOILS CONSISTENCY Very soft Soft Firm Stiff Very stiff Hard	SHEAR STRENGTH (Cu) <12 kPa 12-25 kPa 25-50 kPa 50-100 kPa 100-200 kPa >200 kPa	 Water infiltration  Groundwater table

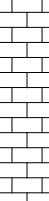

Remark(s):

DEPTH (m)	DEPTH - ft	ELEVATION (m)	STRATIGRAPHIC DESCRIPTION	SYMBOLS	SAMPLES				BLOW COUNTS/150mm	VANE TEST (KPa)	PENETRATION TEST				WATER LEVEL	LABORATORY TESTS
					TYPE & NO	STATE	RECOVERY (%)	N, Ndc or RQD			▲ : N standard penetration	△ : Ndc dynamic penetration	20	40		
10					SS-10	X	75	41	10-20-21-41							G W = 14%
11		36.28	Bedrock: Grey LIMESTONE with SHALE, fair to good quality		RC-11	█	100	63								Qu = 73
12					RC-12	█	100	90								
13																
14		33.28	END OF BOREHOLE													
15																
16																
17																
18																
19																
20																
21																
22																
23																
24																
25																

Project : **Wind Energy Converters (WEC)**
 Client : **TRANSALTA**
 Location : **Saint-Valentin, Québec**
 Drilling contractor : **Explora-sol inc.**
 Drilling type : **Casing**
 Diameter : **76,2 mm**
 Field technician : **Bernard Huppé, géo.**

O/F : **G1-09-1532**
 Geodesic coordinates (NAD-1983) X: **319312**
 Y: **4997246**
 Date of drilling : **2010-03-16**
 Drilling depth (m) : **11.15**

SOIL STATE Disturbed Intact Lost Core sample	TERMINOLOGY "traces" 1-10% "some" 10-20% adjective (sandy...) 20-35% "and" 35-50% SYMBOLS N N-value (Standard penetration test) R Refusal R.Q.D Rock Quality Designation % R.Q.D Σ Length of sound pieces > 100 mm Total core run length	ROCK QUALITY DESIGNATION % RQD QUALITATIVE <25 Very poor 25-50 Poor 50-75 Fair 75-90 Good 90-100 Excellent CLASSIFICATION Clay < 0,002 mm Silt 0,002 à 0,08 mm Sand 0,08 à 5 mm Gravel 5 à 80 mm Cobbles 80 à 300 mm Boulders > 300 mm	COMPACTION INDEX "N" Very loose 0-4 Loose 4-10 Compact 10-30 Dense 30-50 Very dense >50 COHESIVE SOILS CONSISTENCY Very soft Soft Firm Stiff Very stiff Hard	WATER LEVEL (m) Date: 2010-04-26 Date: Depth: 0.92 Depth: Water infiltration Groundwater table
TYPE OF SAMPLES SS Split Spoon ST Shelby tube HA Helical auger RC Roc core barrel CA Casing MA Manual				SHEAR STRENGTH (Cu) <12 kPa 12-25 kPa 25-50 kPa 50-100 kPa 100-200 kPa >200 kPa

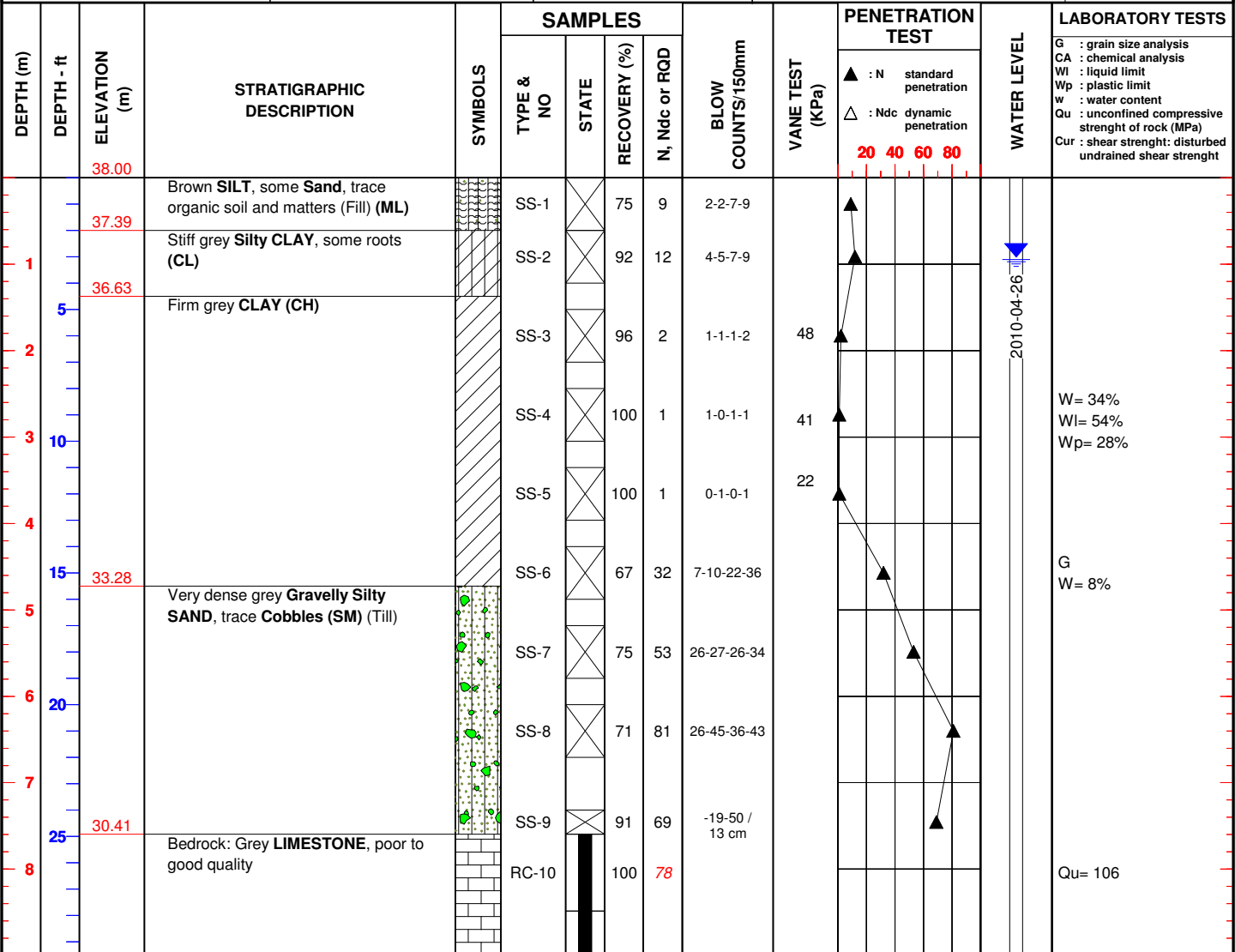







Remark(s):

DEPTH (m)	DEPTH - ft	ELEVATION (m)	STRATIGRAPHIC DESCRIPTION	SYMBOLS	SAMPLES				BLOW COUNTS/150mm	VANE TEST (KPa)	PENETRATION TEST				WATER LEVEL	LABORATORY TESTS
					TYPE & NO	STATE	RECOVERY (%)	N, Ndc or RQD			▲ : N standard penetration	△ : Ndc dynamic penetration	20	40		
10					RC-11		100	39								
11	35	26.85	END OF BOREHOLE		RC-12		100	79								
12	40															
13	45															
14	50															
15	55															
16	60															
17	65															
18	70															
19	75															
20	80															
21																
22																
23																
24																
25																

Project : **Wind Energy Converters (WEC)**
 Client : **TRANSALTA**
 Location : **Saint-Valentin, Québec**
 Drilling contractor : **Explora-sol inc.**
 Drilling type : **Casing**
 Diameter : **76,2 mm**
 Field technician : **Karim Boudalia, géo.**

O/F : **G1-09-1532**
 Geodesic coordinates (NAD-1983) X: **319774**
 Y: **5001316**
 Date of drilling : **2010-03-25**
 Drilling depth (m) : **8.53**





SOIL STATE  Disturbed  Intact  Lost  Core sample	TERMINOLOGY "traces" 1-10% "some" 10-20% adjective (sandy...) 20-35% "and" 35-50% SYMBOLS N N-value (Standard penetration test) R Refusal R.Q.D Rock Quality Designation % R.Q.D Σ Length of sound pieces > 100 mm Total core run length	ROCK QUALITY DESIGNATION % RQD QUALITATIVE <25 Very poor 25-50 Poor 50-75 Fair 75-90 Good 90-100 Excellent	COMPACTION INDEX "N" Very loose 0-4 Loose 4-10 Compact 10-30 Dense 30-50 Very dense >50	WATER LEVEL (m) Date: 2010-04-26 Date: Depth: 2.46 Depth:
TYPE OF SAMPLES SS Split Spoon ST Shelby tube HA Helical auger RC Roc core barrel CA Casing MA Manual	CLASSIFICATION Clay < 0,002 mm Silt 0,002 à 0,08 mm Sand 0,08 à 5 mm Gravel 5 à 80 mm Cobbles 80 à 300 mm Boulders > 300 mm	COHESIVE SOILS CONSISTENCY Very soft Soft Firm Stiff Very stiff Hard	SHEAR STRENGTH (Cu) <12 kPa 12-25 kPa 25-50 kPa 50-100 kPa 100-200 kPa >200 kPa	 Water infiltration  Groundwater table

DEPTH (m)	DEPTH - ft	ELEVATION (m)	STRATIGRAPHIC DESCRIPTION	SYMBOLS	SAMPLES			BLOW COUNTS/150mm	VANE TEST (kPa)	PENETRATION TEST				WATER LEVEL	LABORATORY TESTS
					TYPE & NO	STATE	RECOVERY (%)			N _j Ndc or RQD	▲ : N standard penetration	△ : Ndc dynamic penetration	20		
		40.84													
		40.23	Brown SILT, trace Sand and Gravel. Presence of organic matter (Fill)		SS-1	×	67	4	1-2-2-6						
1			Compact brown SAND, some Silt (SM) (Till)		SS-2	×	21	20	10-10-10-29						
5		39.32	Compact grey SILT and SAND, trace Gravel (ML) (Till)		SS-3	×	83	23	11-12-11-12						
2					SS-4	×	42	19	6-8-11-8						
3	10				SS-5	×	0	22	8-11-11-13						
4					SS-6	×	50	14	9-5-9-18						
5	15				SS-7	×	78	67	-17-50 / 8 cm						
6	20	35.43	Bedrock: Black LIMESTONE and SHALE, fair to excellent quality		RC-8	█	96	74							
7					RC-9	█	95	96							Qu= 79
8	25				RC-10	█	100	100							
		32.31	END OF BOREHOLE												

Remark(s):



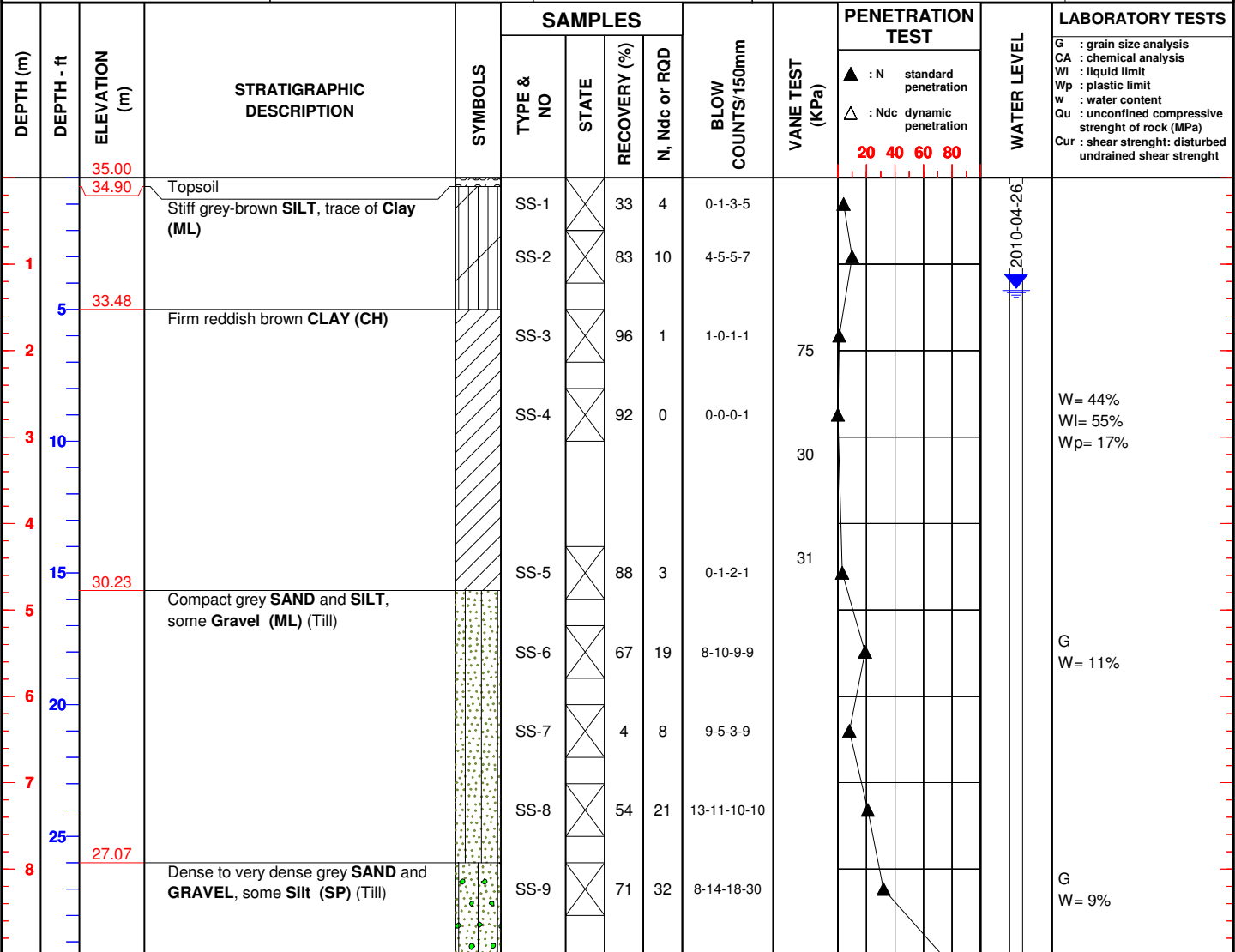

Project : **Wind Energy Converters (WEC)**
 Client : **TRANSALTA**
 Location : **Saint-Valentin, Québec**
 Drilling contractor : **Explora-sol inc.**
 Drilling type : **Casing**
 Diameter : **76,2 mm**
 Field technician : **Karim Boudalia, géo.**

O/F : **G1-09-1532**
 Geodesic coordinates (NAD-1983) X: **319664**
 Y: **4996999**
 Date of drilling : **2010-04-19**
 Drilling depth (m) : **14.15**

SOIL STATE  Disturbed  Intact  Lost  Core sample		TERMINOLOGY "traces" 1-10% "some" 10-20% adjective (sandy...) 20-35% "and" 35-50%		ROCK QUALITY DESIGNATION % RQD QUALITATIVE <25 Very poor 25-50 Poor 50-75 Fair 75-90 Good 90-100 Excellent		COMPACTION INDEX "N" Very loose 0-4 Loose 4-10 Compact 10-30 Dense 30-50 Very dense >50		WATER LEVEL (m) Date: 2010-04-26 Date: Depth: 1.28 Depth:	
TYPE OF SAMPLES SS Split Spoon ST Shelby tube HA Helical auger RC Roc core barrel CA Casing MA Manual		SYMBOLS N N-value (Standard penetration test) R Refusal R.Q.D Rock Quality Designation % R.Q.D Σ Length of sound pieces > 100 mm Total core run length		CLASSIFICATION Clay < 0,002 mm Silt 0,002 à 0,08 mm Sand 0,08 à 5 mm Gravel 5 à 80 mm Cobbles 80 à 300 mm Boulders > 300 mm		COHESIVE SOILS CONSISTENCY Very soft Soft Firm Stiff Very stiff Hard		SHEAR STRENGTH (Cu) <12 kPa 12-25 kPa 25-50 kPa 50-100 kPa 100-200 kPa >200 kPa	









Remark(s):

DEPTH (m)	DEPTH - ft	ELEVATION (m)	STRATIGRAPHIC DESCRIPTION	SYMBOLS	SAMPLES				BLOW COUNTS/150mm	VANE TEST (KPa)	PENETRATION TEST				WATER LEVEL	LABORATORY TESTS
					TYPE & NO	STATE	RECOVERY (%)	N, Ndc or RGD			▲ : N standard penetration	△ : Ndc dynamic penetration	20	40		
10		24.48	Bedrock: Black LIMESTONE , fair to excellent quality		SS-10	⊗	83	97	26-49-48-50 / 13 cm							
11	35				SS-11	⊗	75	75	-50 / 10 cm							
12	40				RC-12	█	92	56								
13	45				RC-13	█	100	100								
14	50	20.85			RC-14	█	97	70								
15	55		END OF BOREHOLE													
16	60															
17	65															
18	70															
19	75															
20	80															
21																
22																
23																
24																
25																

Qu= 109



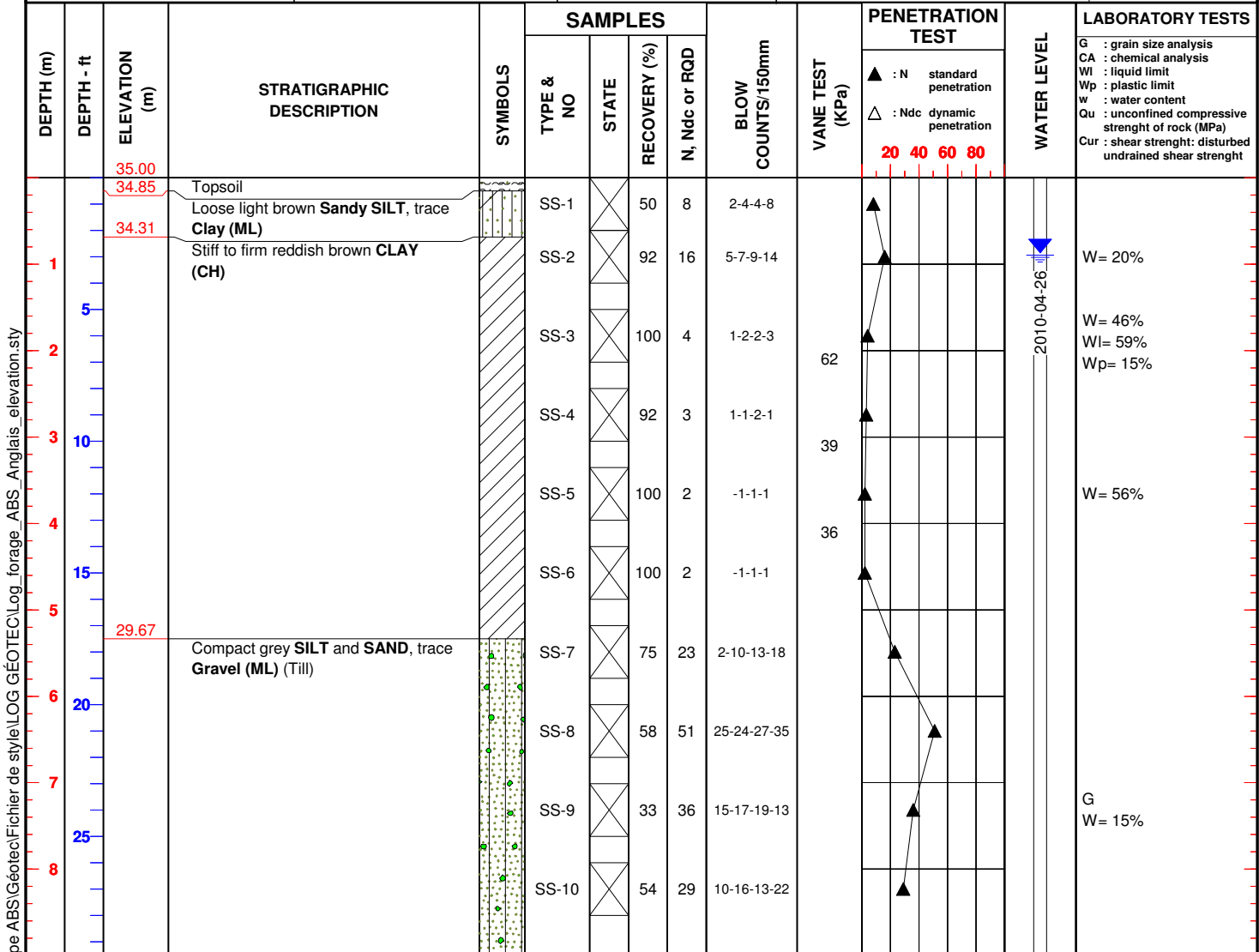

Project : **Wind Energy Converters (WEC)**
 Client : **TRANSALTA**
 Location : **Saint-Valentin, Québec**
 Drilling contractor : **Explora-sol inc.**
 Drilling type : **Casing**
 Diameter : **76,2 mm**
 Field technician : **Rock Samson, tech.**

O/F : **G1-09-1532**
 Geodesic coordinates (NAD-1983) X: **319665**
 Y: **4997492**
 Date of drilling : **2010-04-15**
 Drilling depth (m) : **13.72**

SOIL STATE  Disturbed  Intact  Lost  Core sample		TERMINOLOGY "traces" 1-10% "some" 10-20% adjective (sandy...) 20-35% "and" 35-50%		ROCK QUALITY DESIGNATION % RQD QUALITATIVE <25 Very poor 25-50 Poor 50-75 Fair 75-90 Good 90-100 Excellent		COMPACTION INDEX "N" Very loose 0-4 Loose 4-10 Compact 10-30 Dense 30-50 Very dense >50		WATER LEVEL (m) Date: 2010-04-26 Date: Depth: 0.87 Depth:		
TYPE OF SAMPLES SS Split Spoon ST Shelby tube HA Helical auger RC Roc core barrel CA Casing MA Manual		SYMBOLS N N-value (Standard penetration test) R Refusal R.Q.D Rock Quality Designation % R.Q.D Σ Length of sound pieces > 100 mm Total core run length		CLASSIFICATION Clay < 0,002 mm Silt 0,002 à 0,08 mm Sand 0,08 à 5 mm Gravel 5 à 80 mm Cobbles 80 à 300 mm Boulders > 300 mm		COHESIVE SOILS CONSISTENCY Very soft Soft Firm Stiff Very stiff Hard		SHEAR STRENGTH (Cu) <12 kPa 12-25 kPa 25-50 kPa 50-100 kPa 100-200 kPa >200 kPa		 Water infiltration  Groundwater table









Remark(s):

DEPTH (m)	DEPTH - ft	ELEVATION (m)	STRATIGRAPHIC DESCRIPTION	SYMBOLS	SAMPLES				BLOW COUNTS/150mm	VANE TEST (KPa)	PENETRATION TEST				WATER LEVEL	LABORATORY TESTS
					TYPE & NO	STATE	RECOVERY (%)	N, Ndc or RQD			▲ : N standard penetration	△ : Ndc dynamic penetration	20	40		
		25.78	Cobbles and Boulders		SS-11		13		-50 / 8 cm							
10					RC-12		30									
		24.33	Bedrock: Black LIMESTONE, poor quality		RC-13		100	13								
11					RC-14		100	35								Qu = 80
12																
13																
		21.28	END OF BOREHOLE													
14																
15																
16																
17																
18																
19																
20																
21																
22																
23																
24																
25																

Borehole N° 10BH-28A

Project : **Wind Energy Converters (WEC)**
 Client : **TRANSALTA**
 Location : **Saint-Valentin, Québec**
 Drilling contractor : **Explora-sol inc.**
 Drilling type : **Casing**
 Diameter : **76,2 mm**
 Field technician : **Karim Boudalia, géo.**

O/F : **G1-09-1532**
 Geodesic coordinates (NAD-1983) X: **319414**
 Y: **4997499**
 Date of drilling : **2010-04-15**
 Drilling depth (m) : **15.22**

SOIL STATE  Disturbed  Intact  Lost  Core sample	TERMINOLOGY "traces" 1-10% "some" 10-20% adjective (sandy...) 20-35% "and" 35-50% SYMBOLS N N-value (Standard penetration test) R Refusal R.Q.D Rock Quality Designation % R.Q.D Σ Length of sound pieces > 100 mm Total core run length	ROCK QUALITY DESIGNATION % RQD QUALITATIVE <25 Very poor 25-50 Poor 50-75 Fair 75-90 Good 90-100 Excellent	COMPACTION INDEX "N" Very loose 0-4 Loose 4-10 Compact 10-30 Dense 30-50 Very dense >50	WATER LEVEL (m) Date: 2010-04-26 Date: Depth: 0.78 Depth:
TYPE OF SAMPLES SS Split Spoon ST Shelby tube HA Helical auger RC Roc core barrel CA Casing MA Manual	CLASSIFICATION Clay < 0,002 mm Silt 0,002 à 0,08 mm Sand 0,08 à 5 mm Gravel 5 à 80 mm Cobbles 80 à 300 mm Boulders > 300 mm	COHESIVE SOILS CONSISTENCY Very soft Soft Firm Stiff Very stiff Hard	SHEAR STRENGTH (Cu) <12 kPa 12-25 kPa 25-50 kPa 50-100 kPa 100-200 kPa >200 kPa	 Water infiltration  Groundwater table

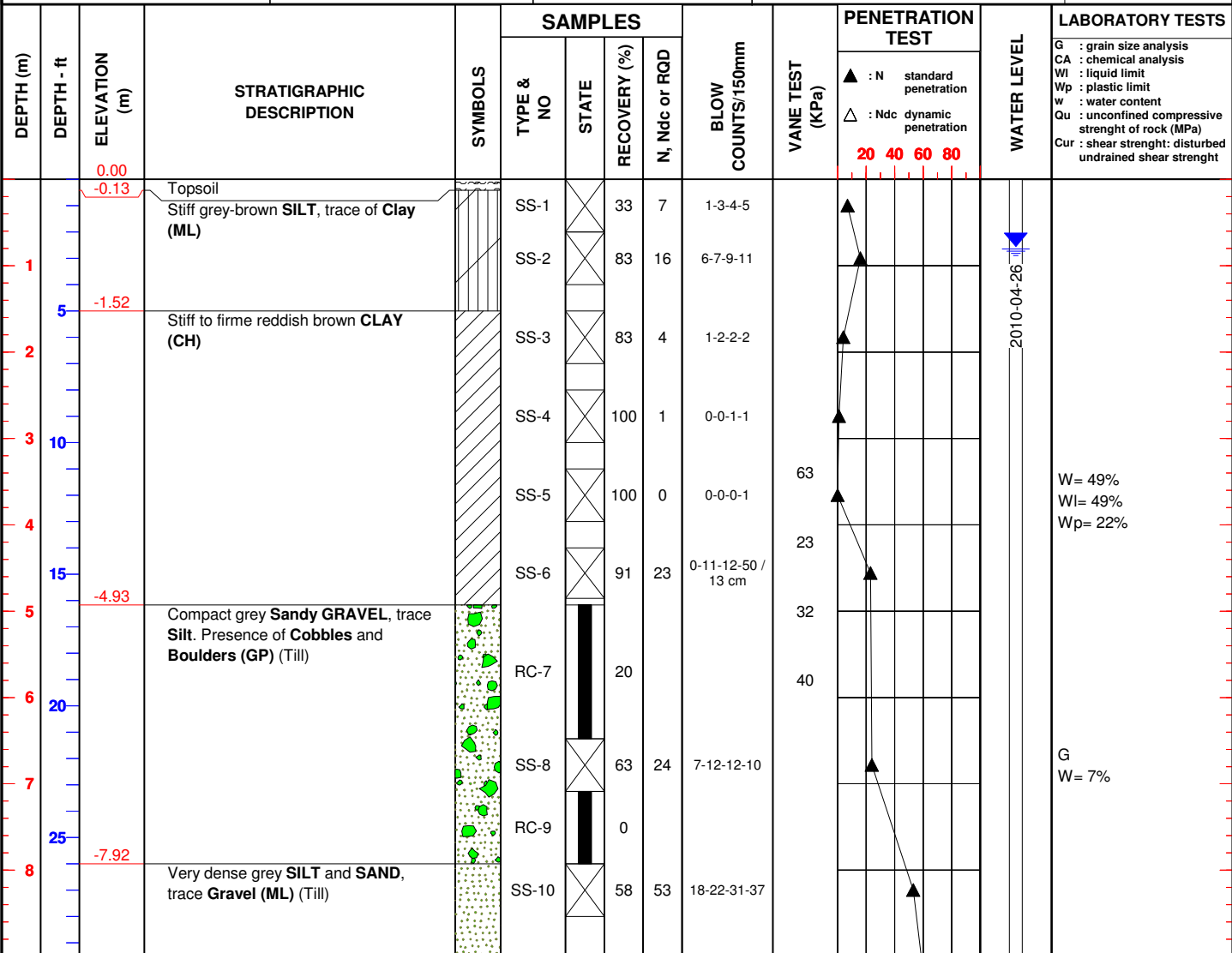







Remark(s):

DEPTH (m)	DEPTH - ft	ELEVATION (m)	STRATIGRAPHIC DESCRIPTION	SYMBOLS	SAMPLES				BLOW COUNTS/150mm	VANE TEST (KPa)	PENETRATION TEST				WATER LEVEL	LABORATORY TESTS
					TYPE & NO	STATE	RECOVERY (%)	N, Ndc or RQD			▲ : N standard penetration	△ : Ndc dynamic penetration	20	40		
10	35			[Dotted pattern]	SS-11	⊗	67	62	15-32-30-31							G W= 14%
11				[Dotted pattern]	SS-12	⊗	96	58	15-24-34-44							
12	40	-11.91	Bedrock: Black LIMESTONE , poor to excellent quality	[Brick pattern]	SS-13	█	0		-50 / 3 cm							Qu= 103
13				[Brick pattern]	RC-14		88	43								
14	45			[Brick pattern]	RC-15		100	60								
15	50	-15.22	FIN DU FORAGE	[Brick pattern]	RC-16		94	91								
16																
17	55															
18	60															
19																
20	65															
21																
22	70															
23	75															
24																
25	80															

Borehole N° 10BH-29

Project : **Wind Energy Converters (WEC)**
 Client : **TRANSALTA**
 Location : **Saint-Valentin, Québec**
 Drilling contractor : **Explora-sol inc.**
 Drilling type : **Casing**
 Diameter : **76,2 mm**
 Field technician : **Karim Boudalia, géo.**

O/F : **G1-09-1532**
 Geodesic coordinates (NAD-1983) X: **319828**
 Y: **5002096**
 Date of drilling : **2010-03-25**
 Drilling depth (m) : **6.71**







SOIL STATE  Disturbed  Intact  Lost  Core sample	TERMINOLOGY "traces" 1-10% "some" 10-20% adjective (sandy...) 20-35% "and" 35-50% SYMBOLS N N-value (Standard penetration test) R Refusal R.Q.D Rock Quality Designation % R.Q.D Σ Length of sound pieces > 100 mm Total core run length	ROCK QUALITY DESIGNATION % RQD QUALITATIVE <25 Very poor 25-50 Poor 50-75 Fair 75-90 Good 90-100 Excellent	COMPACTION INDEX "N" Very loose 0-4 Loose 4-10 Compact 10-30 Dense 30-50 Very dense >50	WATER LEVEL (m) Date: 2010-04-26 Date: Depth: 1.00 Depth:	
TYPE OF SAMPLES SS Split Spoon ST Shelby tube HA Helical auger RC Roc core barrel CA Casing MA Manual	CLASSIFICATION Clay < 0,002 mm Silt 0,002 à 0,08 mm Sand 0,08 à 5 mm Gravel 5 à 80 mm Cobbles 80 à 300 mm Boulders > 300 mm		COHESIVE SOILS CONSISTENCY Very soft Soft Firm Stiff Very stiff Hard	SHEAR STRENGTH (Cu) <12 kPa 12-25 kPa 25-50 kPa 50-100 kPa 100-200 kPa >200 kPa	 Water infiltration  Groundwater table

DEPTH (m)	DEPTH - ft	ELEVATION (m)	STRATIGRAPHIC DESCRIPTION	SYMBOLS	SAMPLES			BLOW COUNTS/150mm	VANE TEST (kPa)	PENETRATION TEST				WATER LEVEL	LABORATORY TESTS
					TYPE & NO	STATE	RECOVERY (%)			N _j Ndc or RQD	▲ : N standard penetration	△ : Ndc dynamic penetration	20		
		45.00	Brown SILT, trace Sand and Gravel. Presence of organic matter (Fill)		SS-1	⊗	83	4	2-1-3-6						
1		43.83	Dense grey SILT and SAND, trace to some Gravel. Presence of cobbles (ML-SM) (Till)		SS-2	⊗	23	83	22-33-50-50 / 10 cm						
2					SS-3	⊗	96	39	18-21-18-20						G W = 11%
3					SS-4	⊗	73	54	-4-50 / 13 cm						
4		40.96	Bedrock: Black LIMESTONE and SHALE, fair to excellent quality		SS-5	⊗	70	38	13-16-22-50 / 5 cm						G W = 10%
5					RC-6	█	57	0							
6					RC-7	█	56	0							
7					RC-8	█	84	63							Qu = 85
8		38.29	END OF BOREHOLE		RC-9	█	89	91							

Remark(s):

Project : **Wind Energy Converters (WEC)**
 Client : **TRANSALTA**
 Location : **Saint-Valentin, Québec**
 Drilling contractor : **Explora-sol inc.**
 Drilling type : **Casing**
 Diameter : **76,2 mm**
 Field technician : **Karim Boudalia, géo.**

O/F : **G1-09-1532**
 Geodesic coordinates (NAD-1983) X: **320091**
 Y: **5001646**
 Date of drilling : **2010-03-22**
 Drilling depth (m) : **13.23**

SOIL STATE  Disturbed  Intact  Lost  Core sample	TERMINOLOGY "traces" 1-10% "some" 10-20% adjective (sandy...) 20-35% "and" 35-50% SYMBOLS N N-value (Standard penetration test) R Refusal R.Q.D Rock Quality Designation % R.Q.D Σ Length of sound pieces > 100 mm Total core run length	ROCK QUALITY DESIGNATION % RQD QUALITATIVE <25 Very poor 25-50 Poor 50-75 Fair 75-90 Good 90-100 Excellent CLASSIFICATION Clay < 0,002 mm Silt 0,002 à 0,08 mm Sand 0,08 à 5 mm Gravel 5 à 80 mm Cobbles 80 à 300 mm Boulders > 300 mm	COMPACTION INDEX "N" Very loose 0-4 Loose 4-10 Compact 10-30 Dense 30-50 Very dense >50 COHESIVE SOILS CONSISTENCY Very soft Soft Firm Stiff Very stiff Hard	WATER LEVEL (m) Date: 2010-04-26 Date: Depth: 1.65 Depth:  Water infiltration  Groundwater table
---	---	---	--	---







DEPTH (m)	DEPTH - ft	ELEVATION (m)	STRATIGRAPHIC DESCRIPTION	SYMBOLS	SAMPLES			BLOW COUNTS/150mm	VANE TEST (kPa)	PENETRATION TEST				WATER LEVEL	LABORATORY TESTS
					TYPE & NO	STATE	RECOVERY (%)			N _j Ndc or RQD	▲ : N standard penetration	△ : Ndc dynamic penetration	20		
		41.00	Brown Sandy SILT . Presence of organic matter (Fill)		SS-1	×	75	7	2-3-4-6						
1		40.39	Compact to dense brown Silty Gravelly SAND (SM) (Till)		SS-2	×	96	20	4-8-12-20						
2	5	38.87	Compact to dense grey SILT and SAND , some Gravel (SM-SP) (Till)		SS-3	×	25	47	16-20-27-38						G W= 11%
3	10				SS-4	×	75	31	18-19-12-26						
4					SS-5	×	0	98	-48-50 / 13 cm						
5	15				SS-6	×	50	20	5-11-9-12						G W= 10%
6	20	34.52	Fractured rock: Black LIMESTONE and SHALE , very poor quality		SS-7	×	67	35	10-10-25-33						
7					RC-8	■	53	0							
					RC-9	■	35	10							
8	25				RC-10	■	33	0							

Remark(s):

DEPTH (m)	DEPTH - ft	ELEVATION (m)	STRATIGRAPHIC DESCRIPTION	SYMBOLS	SAMPLES			BLOW COUNTS/150mm	VANE TEST (KPa)	PENETRATION TEST				WATER LEVEL	LABORATORY TESTS	
					TYPE & NO	STATE	RECOVERY (%)			N, Ndc or RQD	▲ : N standard penetration	△ : Ndc dynamic penetration	20			40
10				[Brick pattern symbol]	RC-11		60	0								
					RC-12		61	0								
11	35				RC-13		43	0								
					RC-14		55	0								
12					RC-15		75	0								
					RC-16		71	10								
13		27.77	END OF BOREHOLE													
14																
15																
16																
17																
18																
19																
20																
21																
22																
23																
24																
25																



Project : **Wind Energy Converters (WEC)**
 Client : **TRANSALTA**
 Location : **Saint-Valentin, Québec**
 Drilling contractor : **Explora-sol inc.**
 Drilling type : **Casing**
 Diameter : **76,2 mm**
 Field technician : **Karim Boudalia, géo.**

O/F : **G1-09-1532**
 Geodesic coordinates (NAD-1983) X: **320095**
 Y: **4997479**
 Date of drilling : **2010-04-14**
 Drilling depth (m) : **15.04**

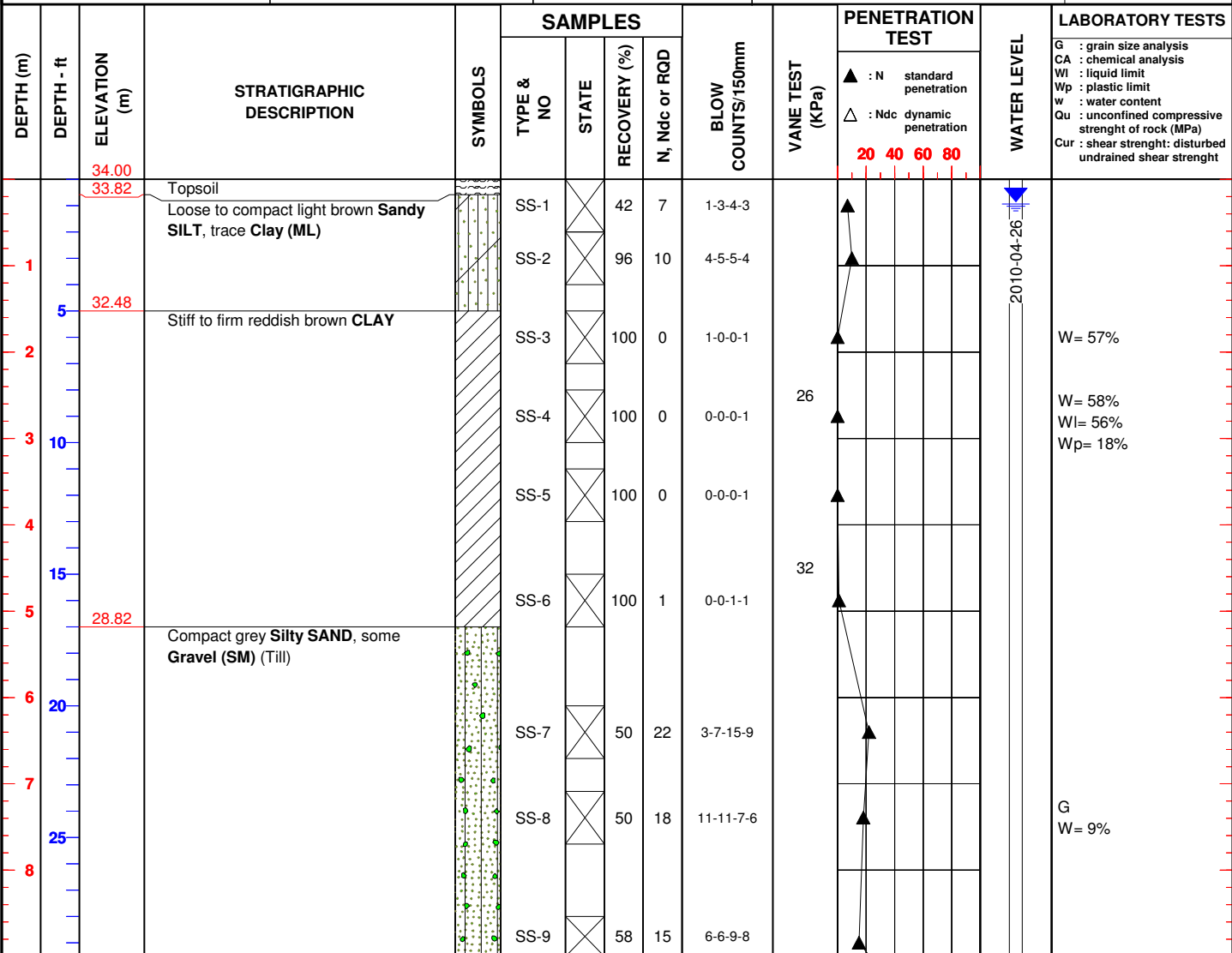
SOIL STATE  Disturbed  Intact  Lost  Core sample	TERMINOLOGY "traces" 1-10% "some" 10-20% adjective (sandy...) 20-35% "and" 35-50% SYMBOLS N N-value (Standard penetration test) R Refusal R.Q.D Rock Quality Designation % R.Q.D Σ Length of sound pieces > 100 mm Total core run length	ROCK QUALITY DESIGNATION % RQD QUALITATIVE <25 Very poor 25-50 Poor 50-75 Fair 75-90 Good 90-100 Excellent	COMPACTION INDEX "N" Very loose 0-4 Loose 4-10 Compact 10-30 Dense 30-50 Very dense >50	WATER LEVEL (m) Date: 2010-04-26 Date: Depth: 0.26 Depth:
TYPE OF SAMPLES SS Split Spoon ST Shelby tube HA Helical auger RC Roc core barrel CA Casing MA Manual	CLASSIFICATION Clay < 0,002 mm Silt 0,002 à 0,08 mm Sand 0,08 à 5 mm Gravel 5 à 80 mm Cobbles 80 à 300 mm Boulders > 300 mm	COHESIVE SOILS CONSISTENCY Very soft Soft Firm Stiff Very stiff Hard	SHEAR STRENGTH (Cu) <12 kPa 12-25 kPa 25-50 kPa 50-100 kPa 100-200 kPa >200 kPa	 Water infiltration  Groundwater table









Remark(s):

DEPTH (m)	DEPTH - ft	ELEVATION (m)	STRATIGRAPHIC DESCRIPTION	SYMBOLS	SAMPLES			BLOW COUNTS/150mm	VANE TEST (KPa)	PENETRATION TEST				WATER LEVEL	LABORATORY TESTS
					TYPE & NO	STATE	RECOVERY (%)			N, Ndc or RGD	▲ : N standard penetration	△ : Ndc dynamic penetration	20		
10		24.55	Very dense grey Gravelly SAND, trace Silt. Presence of Cobbles (SP) (Till)		SS-10	X	83	59	26-30-29-32						Qu = 82
11	35				SS-11	X	50		-50 / 15 cm						
12		22.34	Bedrock: Black LIMESTONE, fair to excellent quality		RC-12	█	82	60							
13	40				RC-13		69	51							
14	45				RC-14		95	97							
15	50	18.96	FIN DU FORAGE												
16															
17	55														
18															
19	60														
20	65														
21															
22	70														
23	75														
24															
25	80														

Borehole N° 10BH-31A

Project : **Wind Energy Converters (WEC)**
 Client : **TRANSALTA**
 Location : **Saint-Valentin, Québec**
 Drilling contractor : **Explora-sol inc.**
 Drilling type : **Casing**
 Diameter : **76,2 mm**
 Field technician : **Karim Boudalia, géo.**

O/F : **G1-09-1532**
 Geodesic coordinates (NAD-1983) X: **319926**
 Y: **4997484**
 Date of drilling : **2010-04-14**
 Drilling depth (m) : **15.57**

SOIL STATE  Disturbed  Intact  Lost  Core sample	TERMINOLOGY "traces" 1-10% "some" 10-20% adjective (sandy...) 20-35% "and" 35-50% SYMBOLS N N-value (Standard penetration test) R Refusal R.Q.D Rock Quality Designation % R.Q.D Σ Length of sound pieces > 100 mm Total core run length	ROCK QUALITY DESIGNATION % RQD QUALITATIVE <25 Very poor 25-50 Poor 50-75 Fair 75-90 Good 90-100 Excellent	COMPACTION INDEX "N" Very loose 0-4 Loose 4-10 Compact 10-30 Dense 30-50 Very dense >50	WATER LEVEL (m) Date: 2010-04-26 Date: Depth: 1.30 Depth:
TYPE OF SAMPLES SS Split Spoon ST Shelby tube HA Helical auger RC Roc core barrel CA Casing MA Manual	CLASSIFICATION Clay < 0,002 mm Silt 0,002 à 0,08 mm Sand 0,08 à 5 mm Gravel 5 à 80 mm Cobbles 80 à 300 mm Boulders > 300 mm	COHESIVE SOILS CONSISTENCY Very soft Soft Firm Stiff Very stiff Hard	SHEAR STRENGTH (Cu) <12 kPa 12-25 kPa 25-50 kPa 50-100 kPa 100-200 kPa >200 kPa	 Water infiltration  Groundwater table

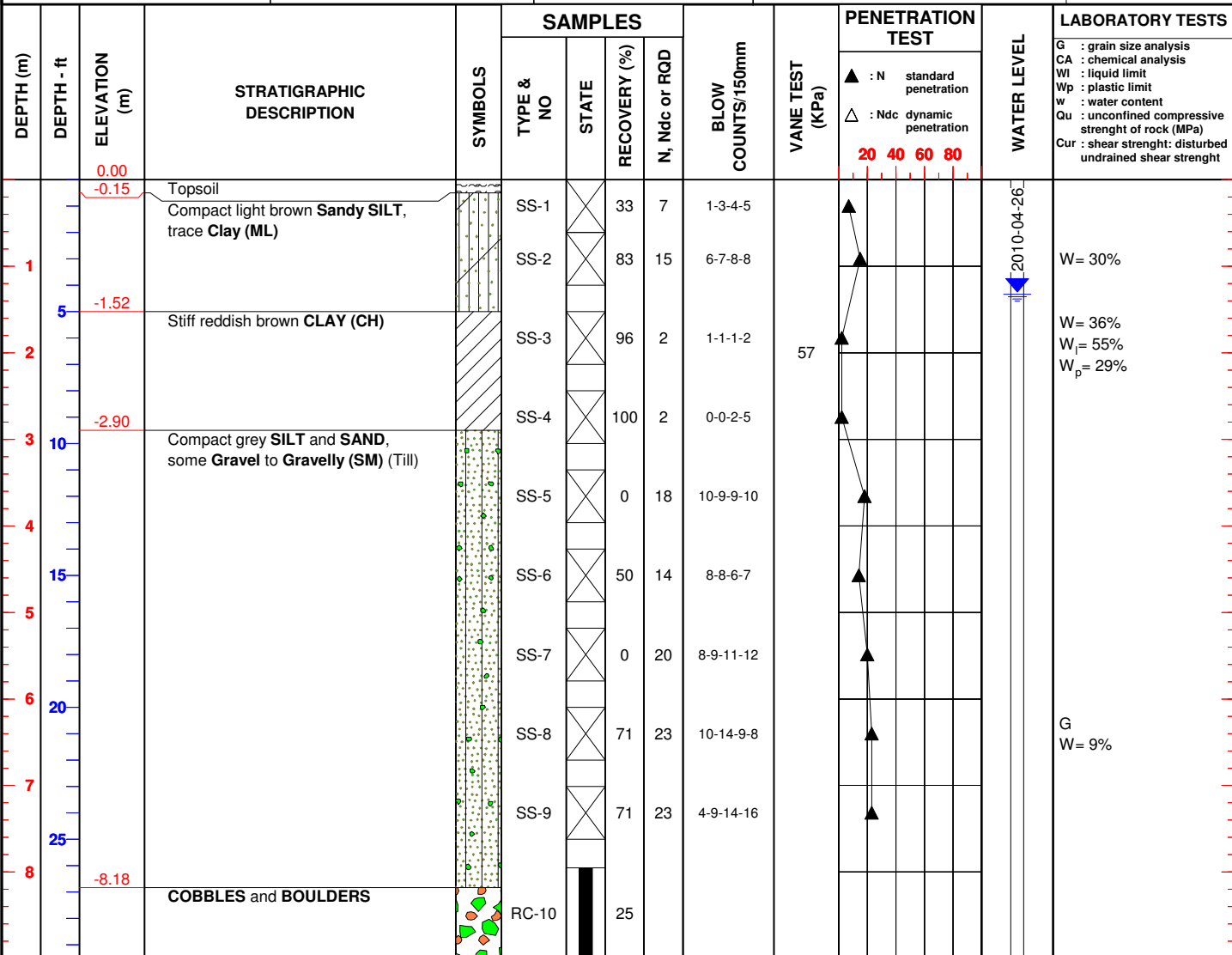







Remark(s):

DEPTH (m)	DEPTH - ft	ELEVATION (m)	STRATIGRAPHIC DESCRIPTION	SYMBOLS	SAMPLES			BLOW COUNTS/150mm	VANE TEST (KPa)	PENETRATION TEST				WATER LEVEL	LABORATORY TESTS
					TYPE & NO	STATE	RECOVERY (%)			N, Ndc or RGD	▲ : N standard penetration	△ : Ndc dynamic penetration	20		
10	35				RC-11		17								
11					RC-12		14								
12	40	-12.60	Bedrock: Black LIMESTONE , good to excellent quality		RC-13		88	83							Qu= 95
13	45				RC-14		100	97							
14	50	-15.57	FIN DU FORAGE												
15	55														
16	60														
17	65														
18	70														
19	75														
20	80														
21															
22															
23															
24															
25															

Project : **Wind Energy Converters (WEC)**
 Client : **TRANSALTA**
 Location : **Saint-Valentin, Québec**
 Drilling contractor : **Explora-sol inc.**
 Drilling type : **Casing**
 Diameter : **76,2 mm**
 Field technician : **Karim Boudalia, géo.**

O/F : **G1-09-1532**
 Geodesic coordinates (NAD-1983) X: **320241**
 Y: **5002214**
 Date of drilling : **2010-03-24**
 Drilling depth (m) : **9.53**

SOIL STATE  Disturbed  Intact  Lost  Core sample	TERMINOLOGY "traces" 1-10% "some" 10-20% adjective (sandy...) 20-35% "and" 35-50% SYMBOLS N N-value (Standard penetration test) R Refusal R.Q.D Rock Quality Designation % R.Q.D Σ Length of sound pieces > 100 mm Total core run length	ROCK QUALITY DESIGNATION % RQD QUALITATIVE <25 Very poor 25-50 Poor 50-75 Fair 75-90 Good 90-100 Excellent	COMPACTION INDEX "N" Very loose 0-4 Loose 4-10 Compact 10-30 Dense 30-50 Very dense >50	WATER LEVEL (m) Date: 2010-04-26 Date: Depth: 1.57 Depth:
TYPE OF SAMPLES SS Split Spoon ST Shelby tube HA Helical auger RC Roc core barrel CA Casing MA Manual	CLASSIFICATION Clay < 0,002 mm Silt 0,002 à 0,08 mm Sand 0,08 à 5 mm Gravel 5 à 80 mm Cobbles 80 à 300 mm Boulders > 300 mm	COHESIVE SOILS CONSISTENCY Very soft Soft Firm Stiff Very stiff Hard	SHEAR STRENGTH (Cu) <12 kPa 12-25 kPa 25-50 kPa 50-100 kPa 100-200 kPa >200 kPa	 Water infiltration  Groundwater table

DEPTH (m)	DEPTH - ft	ELEVATION (m)	STRATIGRAPHIC DESCRIPTION	SYMBOLS	SAMPLES			BLOW COUNTS/150mm	VANE TEST (kPa)	PENETRATION TEST				WATER LEVEL	LABORATORY TESTS
					TYPE & NO	STATE	RECOVERY (%)			N _j Ndc or RQD	▲ : N standard penetration	△ : Ndc dynamic penetration	20		
		43.00													
		42.39	Beige Sandy SILT . Presence of organic matter (Fill)		SS-1	×	75	6	2-3-3-4						
1			Compact beige SILT and SAND , trace Gravel (ML) (Till)		SS-2	×	96	19	5-0-19-22						G W= 6%
5					SS-3	×	88	26	-11-15-50 / 10 cm						
2		40.69	Grey BOULDERS		RC-4	█									
3		40.00	Compact grey Sandy SILT , some Gravel . Presence of Cobbles (ML) (Till)		SS-5	×	80	32	5-11-21-50 / 5 cm						G W= 12%
4					SS-6	×	92	31	12-12-19-26						
5					SS-7	×	83	25	10-9-16-23						
6					SS-8	×	88	29	-13-16-50 / 13 cm						
7		36.60	Bedrock: Black LIMESTONE and SHALE , fair to good quality		SS-9	×	60	50	-50 / 13 cm						Qu= 79
					RC-10	█	78	53							
					RC-11	█	86	85							
					RC-12	█	81	68							







Remark(s):

DEPTH (m)	DEPTH - ft	ELEVATION (m)	STRATIGRAPHIC DESCRIPTION	SYMBOLS	SAMPLES				BLOW COUNTS/150mm	VANE TEST (KPa)	PENETRATION TEST				WATER LEVEL	LABORATORY TESTS
					TYPE & NO	STATE	RECOVERY (%)	N, Ndc or RQD			▲ : N standard penetration	△ : Ndc dynamic penetration	20	40		
		33.48	END OF BOREHOLE													
10																
	35															
11																
	40															
12																
	45															
13																
	50															
14																
	55															
15																
	60															
16																
	65															
17																
	70															
18																
	75															
19																
	80															
20																
	85															
21																
	90															
22																
	95															
23																
	100															
24																
	105															
25																

Borehole N° 10BH-34

Project : **Wind Energy Converters (WEC)**
 Client : **TRANSALTA**
 Location : **Saint-Valentin, Québec**
 Drilling contractor : **Explora-sol inc.**
 Drilling type : **Casing**
 Diameter : **76.2 mm**
 Field technician : **Karim Boudalia, géo.**

O/F : **G1-09-1532**
 Geodesic coordinates (NAD-1983) X: **319415**
 Y: **5002922**
 Date of drilling : **2010-04-08**
 Drilling depth (m) : **9.73**

SOIL STATE  Disturbed  Intact  Lost  Core sample	TERMINOLOGY "traces" 1-10% "some" 10-20% adjective (sandy...) 20-35% "and" 35-50% SYMBOLS N N-value (Standard penetration test) R Refusal R.Q.D Rock Quality Designation % R.Q.D Σ Length of sound pieces > 100 mm Total core run length	ROCK QUALITY DESIGNATION % RQD QUALITATIVE <25 Very poor 25-50 Poor 50-75 Fair 75-90 Good 90-100 Excellent	COMPACTION INDEX "N" Very loose 0-4 Loose 4-10 Compact 10-30 Dense 30-50 Very dense >50	WATER LEVEL (m) Date: 2010-04-26 Date: Depth: 0.72 Depth:
TYPE OF SAMPLES SS Split Spoon ST Shelby tube HA Helical auger RC Roc core barrel CA Casing MA Manual	CLASSIFICATION Clay < 0,002 mm Silt 0,002 à 0,08 mm Sand 0,08 à 5 mm Gravel 5 à 80 mm Cobbles 80 à 300 mm Boulders > 300 mm	COHESIVE SOILS CONSISTENCY Very soft Soft Firm Stiff Very stiff Hard	SHEAR STRENGTH (Cu) <12 kPa 12-25 kPa 25-50 kPa 50-100 kPa 100-200 kPa >200 kPa	 Water infiltration  Groundwater table

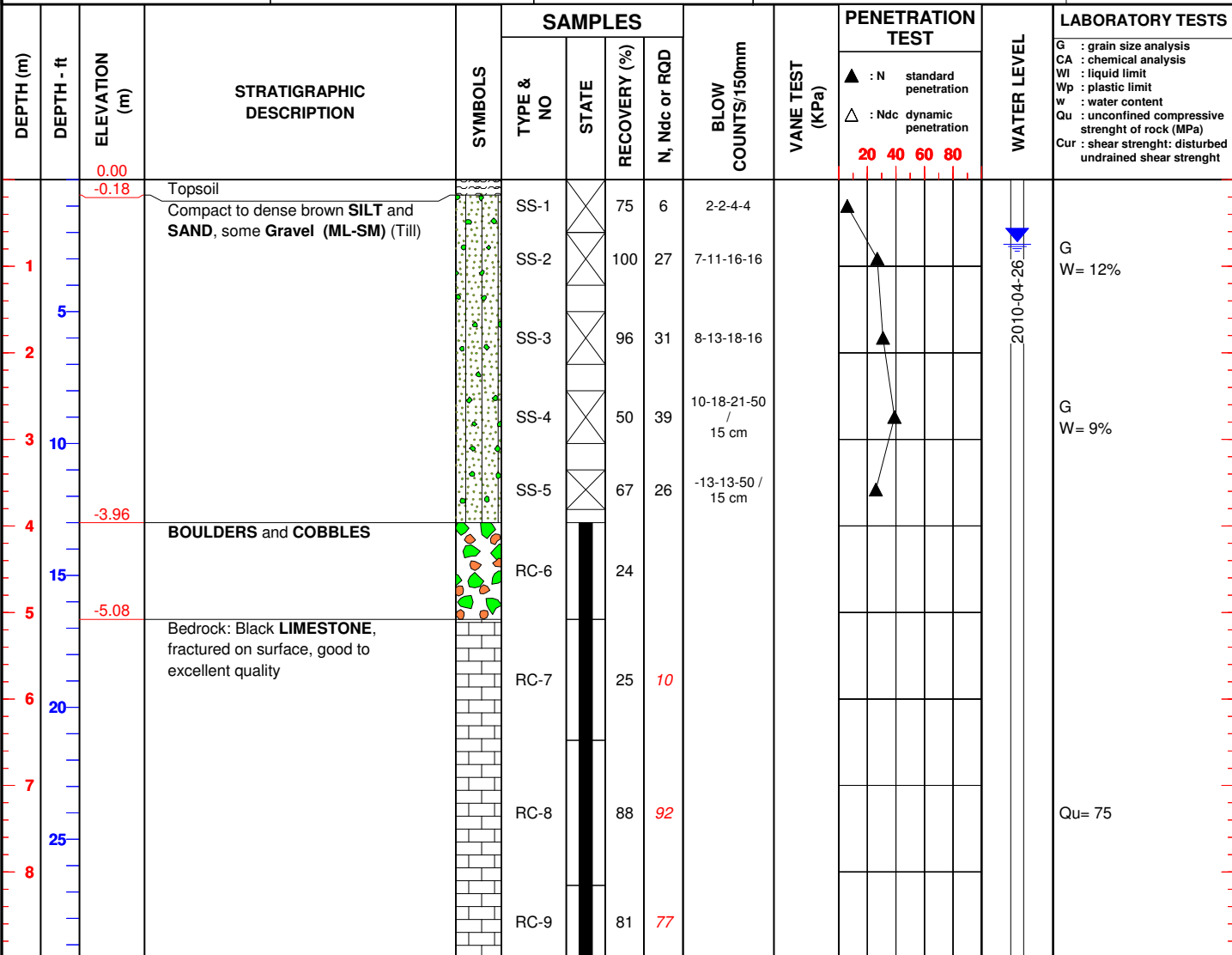





Remark(s):

DEPTH (m)	DEPTH - ft	ELEVATION (m)	STRATIGRAPHIC DESCRIPTION	SYMBOLS	SAMPLES				BLOW COUNTS/150mm	VANE TEST (KPa)	PENETRATION TEST				WATER LEVEL	LABORATORY TESTS
					TYPE & NO	STATE	RECOVERY (%)	N, Ndc or RQD			▲ : N standard penetration	△ : Ndc dynamic penetration	20	40		
		-9.73	END OF BOREHOLE	[Brick symbol]		[Bar symbol]										
10																
	35															
11																
	40															
12																
	45															
13																
	50															
14																
	55															
15																
	60															
16																
	65															
17																
	70															
18																
	75															
19																
	80															
20																
	85															
21																
	90															
22																
	95															
23																
	100															
24																
	105															
25																

Project : **Wind Energy Converters (WEC)**
 Client : **TRANSALTA**
 Location : **Saint-Valentin, Québec**
 Drilling contractor : **Explora-sol inc.**
 Drilling type : **Casing**
 Diameter : **76,2 mm**
 Field technician : **Karim Boudalia, géo.**

O/F : **G1-09-1532**
 Geodesic coordinates (NAD-1983) X: **319169**
 Y: **5002673**
 Date of drilling : **2010-04-08**
 Drilling depth (m) : **14.17**

SOIL STATE  Disturbed  Intact  Lost  Core sample		TERMINOLOGY "traces" 1-10% "some" 10-20% adjective (sandy...) 20-35% "and" 35-50%		ROCK QUALITY DESIGNATION % RQD QUALITATIVE <25 Very poor 25-50 Poor 50-75 Fair 75-90 Good 90-100 Excellent		COMPACTION INDEX "N" Very loose 0-4 Loose 4-10 Compact 10-30 Dense 30-50 Very dense >50		WATER LEVEL (m) Date: 2010-04-26 Date: Depth: 0.64 Depth:	
TYPE OF SAMPLES SS Split Spoon ST Shelby tube HA Helical auger RC Roc core barrel CA Casing MA Manual		SYMBOLS N N-value (Standard penetration test) R Refusal R.Q.D Rock Quality Designation % R.Q.D Σ Length of sound pieces > 100 mm Total core run length		CLASSIFICATION Clay < 0,002 mm Silt 0,002 à 0,08 mm Sand 0,08 à 5 mm Gravel 5 à 80 mm Cobbles 80 à 300 mm Boulders > 300 mm		COHESIVE SOILS CONSISTENCY Very soft Soft Firm Stiff Very stiff Hard		SHEAR STRENGTH (Cu) <12 kPa 12-25 kPa 25-50 kPa 50-100 kPa 100-200 kPa >200 kPa	

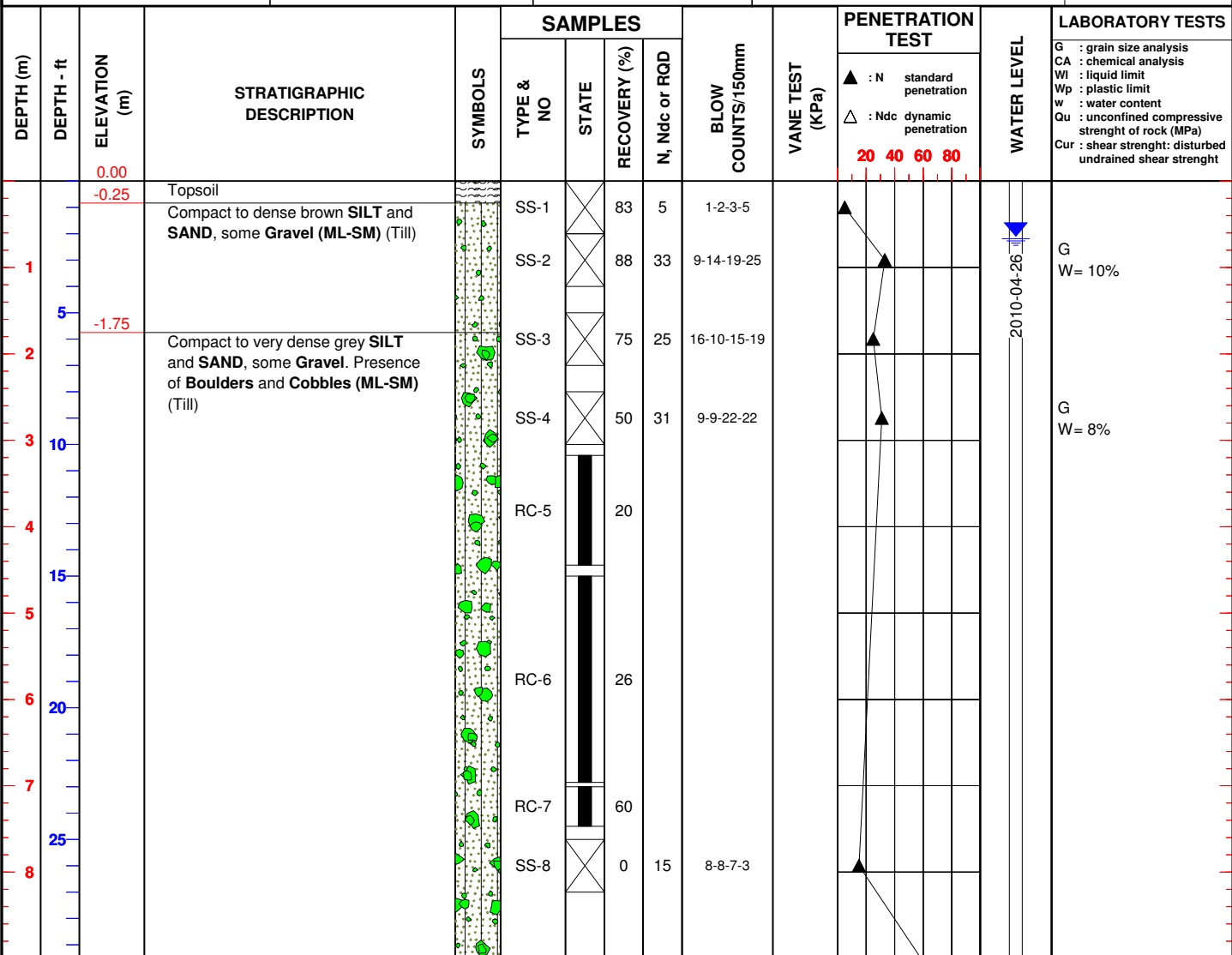

Remark(s):

P:\Multi-Partage Groupe ABS\Géotec\Fichier de style\LOG_GÉOTEC\Log_forage_ABS_Anglais_elevation.sty







DEPTH (m)	DEPTH - ft	ELEVATION (m)	STRATIGRAPHIC DESCRIPTION	SYMBOLS	SAMPLES				BLOW COUNTS/150mm	VANE TEST (KPa)	PENETRATION TEST				WATER LEVEL	LABORATORY TESTS
					TYPE & NO	STATE	RECOVERY (%)	N, Ndc or RGD			▲ : N standard penetration	△ : Ndc dynamic penetration	20	40		
10					SS-9	⊗	88	77	22-38-39-37							
11		-10.85	Bedrock: Black LIMESTONE , fair to excellent quality		SS-10	⊗	86	78	-28-50 / 3 cm							
12					RC-11		77	55								
13					RC-12		97	100								
14		-14.17	END OF BOREHOLE		RC-13		94	93								
15																
16																
17																
18																
19																
20																
21																
22																
23																
24																
25																

P:\Multi-Partage Groupe ABS(Geotec)\Fichier de style\LOG_GÉOTEC\Log_forage_ABS_Anglais_elevation.sty

Qu= 76

Project : **Wind Energy Converters (WEC)**
 Client : **TRANSALTA**
 Location : **Saint-Valentin, Québec**
 Drilling contractor : **Explora-sol inc.**
 Drilling type : **Casing**
 Diameter : **76,2 mm**
 Field technician : **Karim Boudalia, géo.**

O/F : **G1-09-1532**
 Geodesic coordinates (NAD-1983) X: **318483**
 Y: **5001515**
 Date of drilling : **2010-04-23**
 Drilling depth (m) : **10.52**

SOIL STATE  Disturbed  Intact  Lost  Core sample	TERMINOLOGY "traces" 1-10% "some" 10-20% adjective (sandy...) 20-35% "and" 35-50% SYMBOLS N N-value (Standard penetration test) R Refusal R.Q.D Rock Quality Designation % R.Q.D Σ Length of sound pieces > 100 mm Total core run length	ROCK QUALITY DESIGNATION % RQD QUALITATIVE <25 Very poor 25-50 Poor 50-75 Fair 75-90 Good 90-100 Excellent	COMPACTION INDEX "N" Very loose 0-4 Loose 4-10 Compact 10-30 Dense 30-50 Very dense >50	WATER LEVEL (m) Date: 2010-04-26 Date: Depth: 0.68 Depth:
TYPE OF SAMPLES SS Split Spoon ST Shelby tube HA Helical auger RC Roc core barrel CA Casing MA Manual	CLASSIFICATION Clay < 0,002 mm Silt 0,002 à 0,08 mm Sand 0,08 à 5 mm Gravel 5 à 80 mm Cobbles 80 à 300 mm Boulders > 300 mm	COHESIVE SOILS CONSISTENCY Very soft Soft Firm Stiff Very stiff Hard	SHEAR STRENGTH (Cu) <12 kPa 12-25 kPa 25-50 kPa 50-100 kPa 100-200 kPa >200 kPa	 Water infiltration  Groundwater table

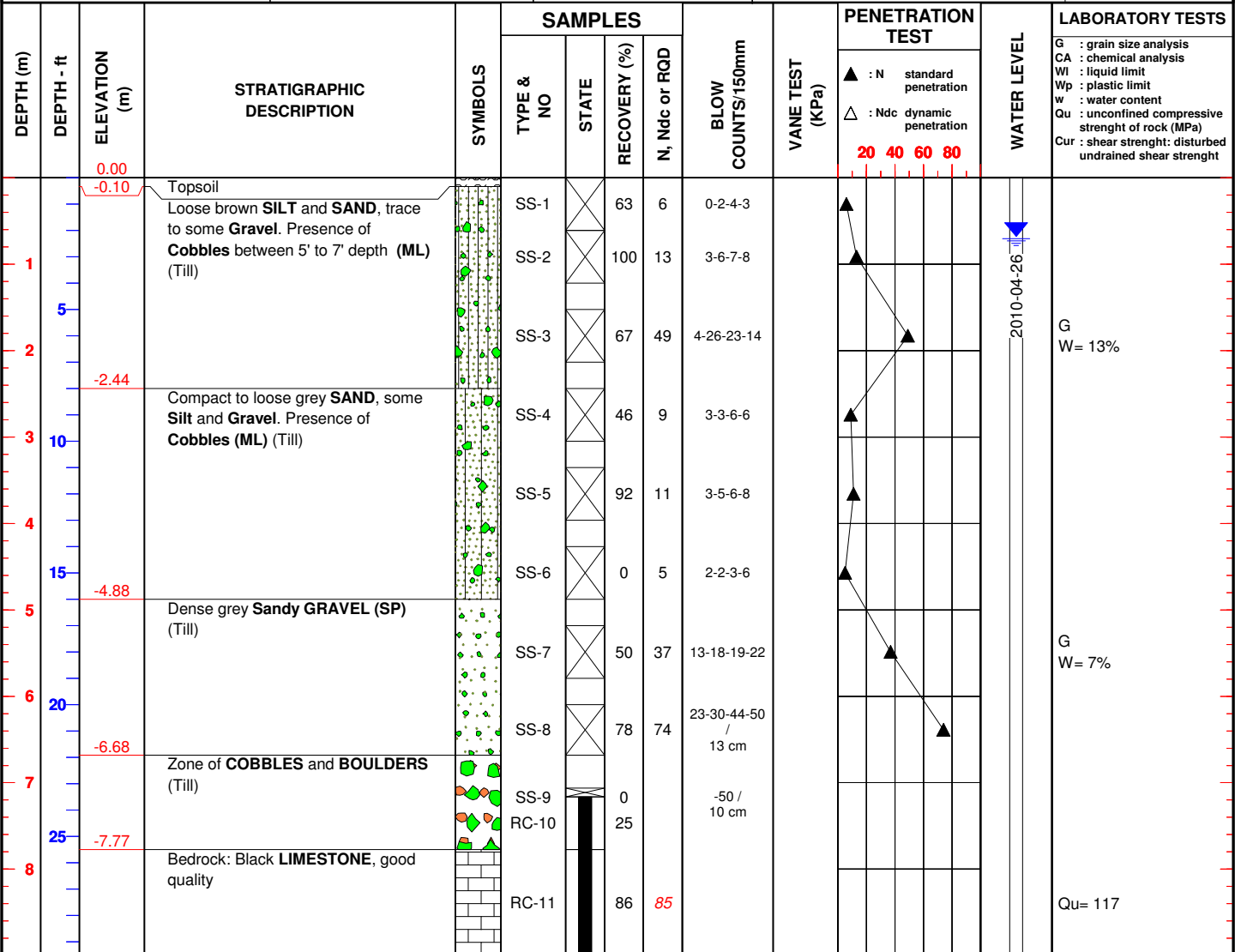

Remark(s):

DEPTH (m)	DEPTH - ft	ELEVATION (m)	STRATIGRAPHIC DESCRIPTION	SYMBOLS	SAMPLES			BLOW COUNTS/150mm	VANE TEST (KPa)	PENETRATION TEST				WATER LEVEL	LABORATORY TESTS
					TYPE & NO	STATE	RECOVERY (%)			N, Ndc or RGD	▲ : N standard penetration	△ : Ndc dynamic penetration	20		
10		-10.52	END OF BOREHOLE	[Brick symbol]	RC-12		92	87							
11															
12															
13															
14															
15															
16															
17															
18															
19															
20															
21															
22															
23															
24															
25															

Appendix D

Laboratory tests

CLIENT TransAlta
 PROJECT Geotechnical study - wind energy converters (WEC)
 LOCATION St-Valentin, Québec

N/D: G1-09-1532

PAGE 1 de 1

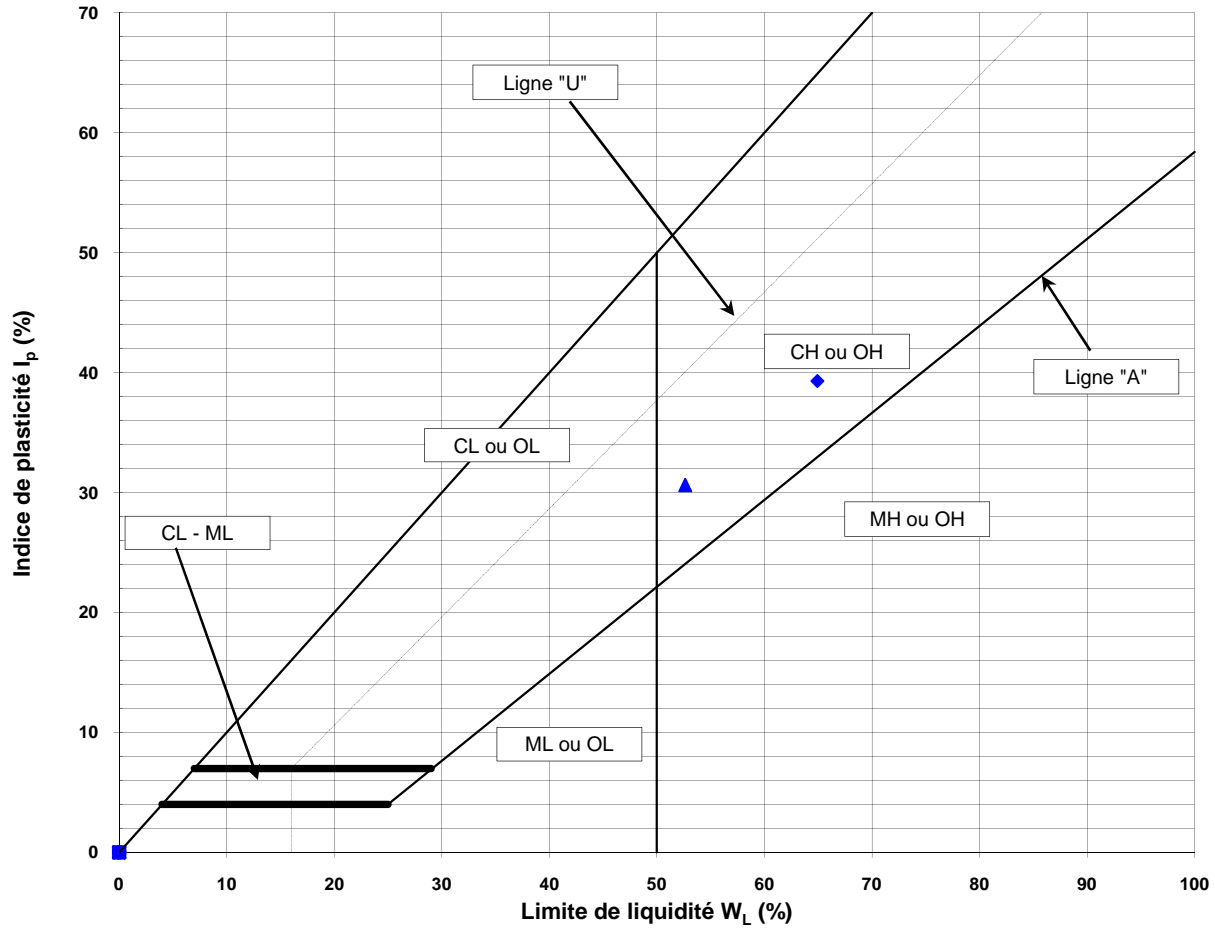

Selon ASTM D-2487

RÉSULTATS

Legend	Boring	Simple n°	Depth (m)	W_n	W_L	W_p	I_p	I_L	Classification
▲	10BH-04	SS-04	2,44 - 3,05	64%	53%	22%	31%	1,4	CH
◆	10BH-12	SS-03	2,13 - 2,74	57%	65%	26%	39%	0,8	CH

CLIENT TransAlta

N/D: G1-09-1532

PROJECT Geotechnical study - Wind energy converters (WEC)

LOCATION St-Valentin (Québec)

PAGE 1 de 1

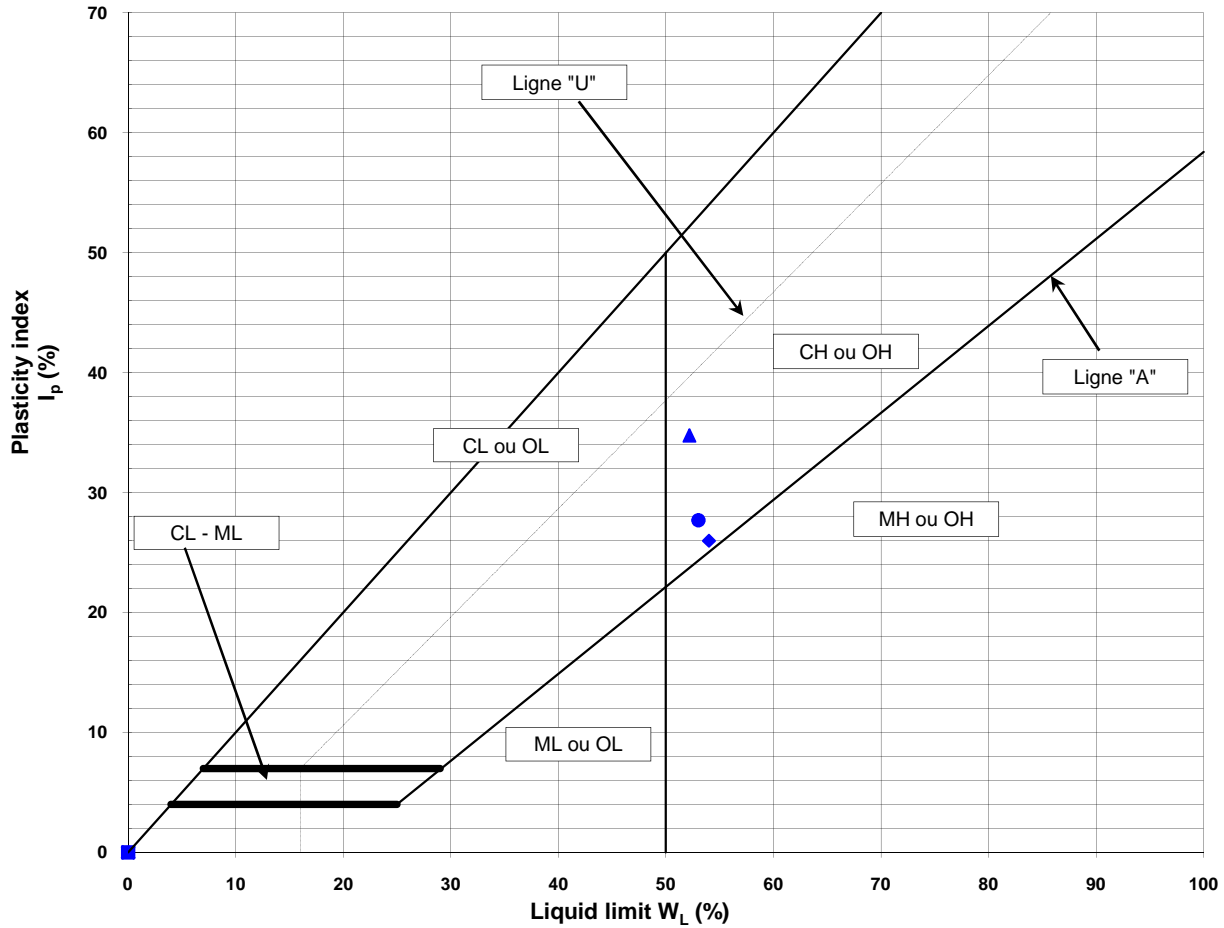

RESULTS INTERPRETATION

Legend	Boring	Sample n°	Depth (m)	W_n	W_L	W_p	I_p	I_L	Classification
▲	10BH-06	SS-03	1,52 - 2,13	56%	52%	17%	35%	1,1	CH
◆	10BH-25	SS-04	2,44 - 3,05	34%	54%	28%	26%	0,2	CH
●	10BH-11	SS-03	1,52 - 2,13	74%	53%	25%	28%	1,8	CH

Prepared by

Daniel Fleury, tech.

Approved by

Ibrahim Ja'far, ing.

Date

2010-04-08

CLIENT TransAlta
 PROJECT Geotechnical study - wind energy converters (WEC)
 LOCATION St-Valentin (Québec)

N/D: G1-09-1532

PAGE 1 de 1

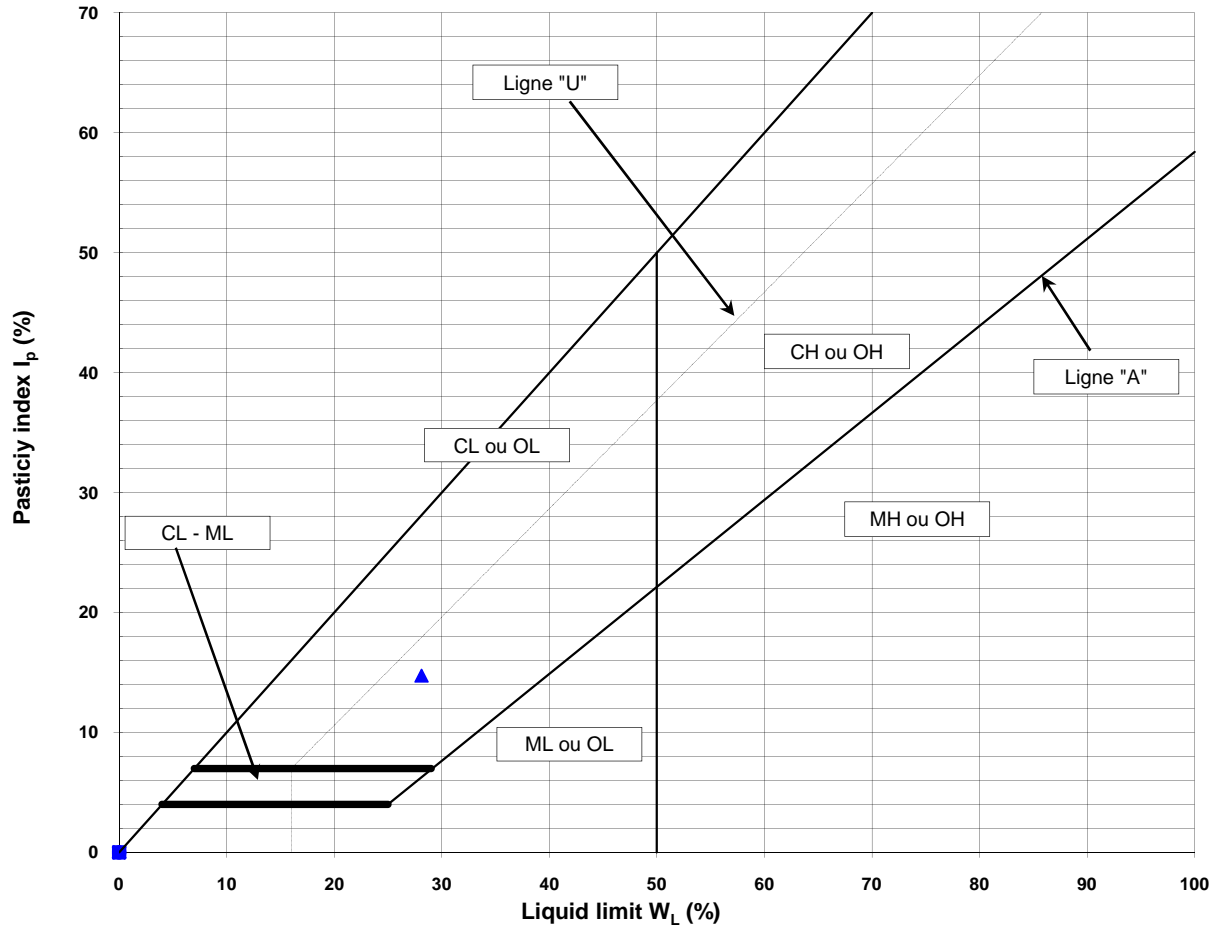

ACCORDING TO ASTM D-2487

RESULTS INTERPRETATION

Legend	Boring	Sample n°	Dept (m)	W _n	W _L	W _p	I _p	I _L	Classification
▲	10BH-17A	SS-03	1,52 - 2,13 m	52%	28%	13%	15%	2,6	CL

CLIENT TransAlta

N/D: G1-09-1532

PROJET Geotechnical study - Wind energy converters (WEC)

ENDROIT St-Valentin (Québec)

PAGE 1 de 1

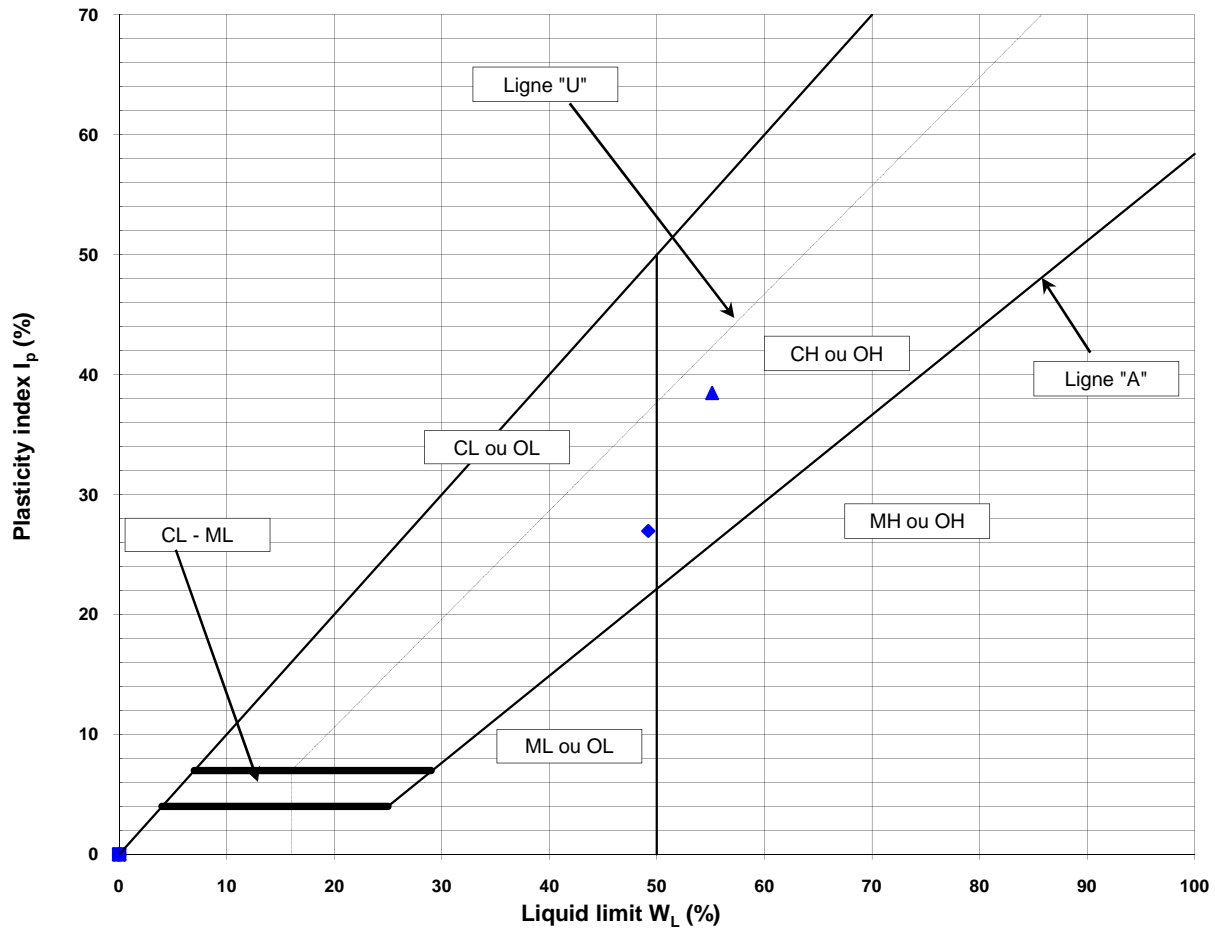

according to ASTM D-2487

RESULTS INTERPRETATION

Legend	Boring	Sample n°	Depth (m)	W_n	W_L	W_p	I_p	I_L	Classification
▲	10BH-27	SS-04	2,44 - 3,05	44%	55%	17%	38%	0,7	CH
◆	10BH-28A	SS-05	3,35 - 3,96	49%	49%	22%	27%	1,0	CH

CLIENT TransAlta
 PROJECT Geotechnical study - Wind energy converters (WEC)
 LOCATION St-valentin (Québec)

N/D: G1-09-1532

PAGE 1 de 1

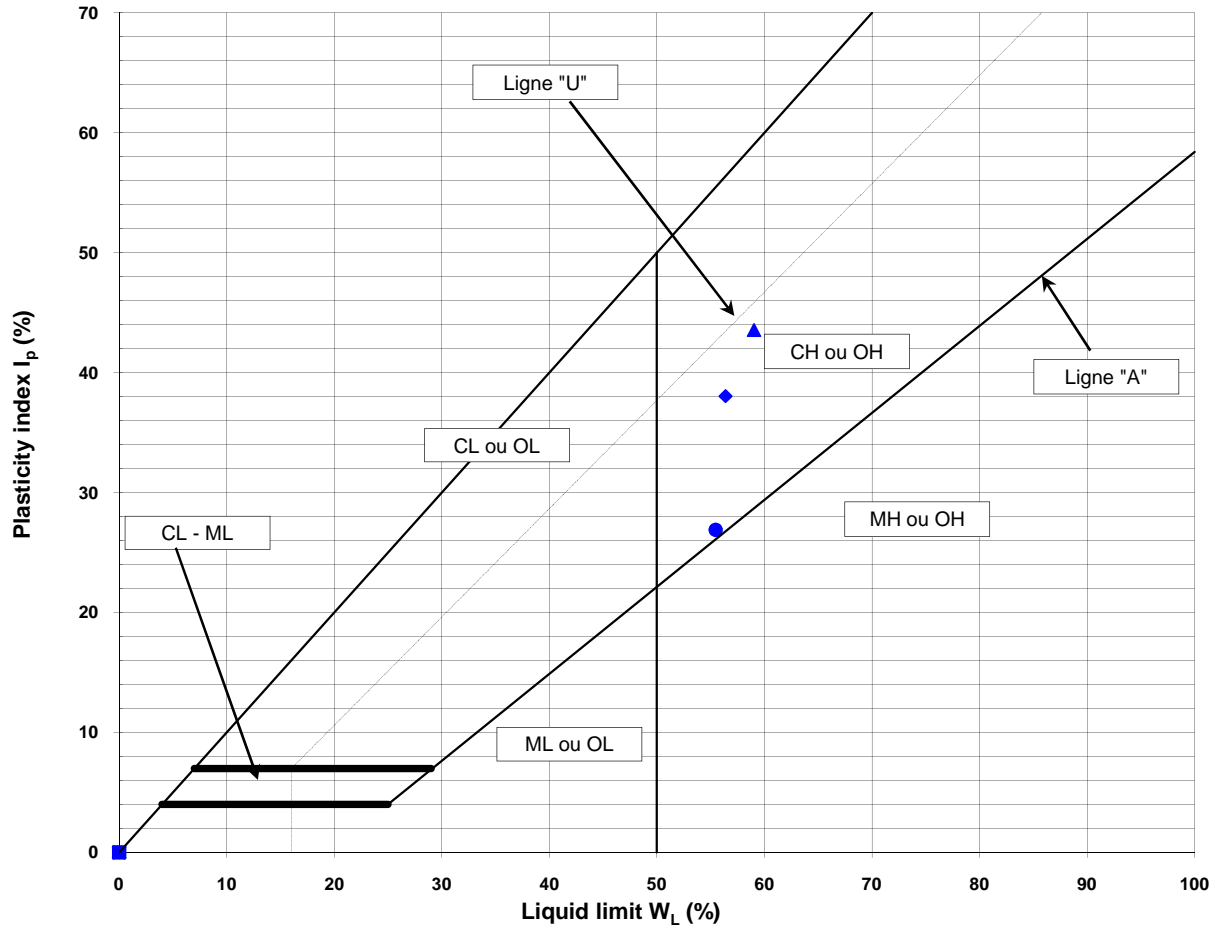

ACCORDING TO ASTM D-2487

RESULTS INTERPRETATION

Legend	Boring	Simple n°	Depth (m)	W _n	W _L	W _p	I _p	I _L	Classification
▲	10BH-28	SS-3	1,52 - 2,13	46%	59%	15%	44%	0,7	CH
◆	10BH-31	SS-04	2,44 - 3,05	58%	56%	18%	38%	1,0	CH
●	10BH-31A	SS-03	1,52 - 2,13	36%	55%	29%	27%	0,3	CH

CLIENT TransAlta **N/D** G1-09-1532
PROJECT Geotechnical study - Wind energy converters (WEC)
LOCATION St-Valentin, Québec **NO. LAB.** 36370

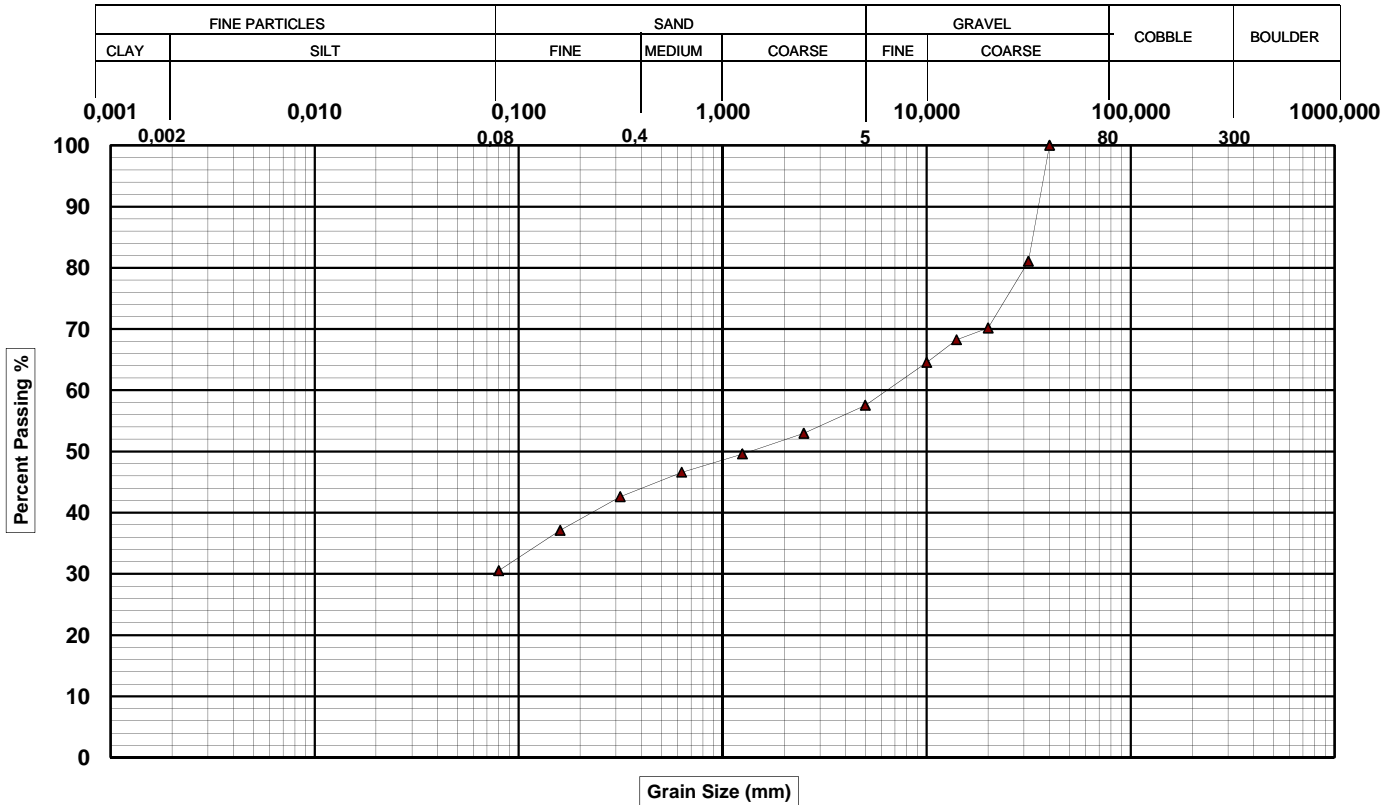

GRAIN-SIZE DISTRIBUTION

Fine Particles		Coarse Particles			
Clay (%)	Silt (%)	Sand (%)	Gravel (%)	Cobble (%)	Boulder (%)
-	30,5	27,0	42,5	0,0	0,0

D₁₀ (mm)	D₃₀ (mm)	D₆₀ (mm)	C_u	C_c	W_n (%)
N/A	N/A	6,50	N/A	N/A	6

PERCENT PASSING

(mm)	(%)	(mm)	(%)	(mm)	(%)
80,00	100	2,500	53		
56,00	100	1,250	50		
40,00	100	0,630	47		
31,50	81	0,315	43		
20,00	70	0,160	37		
14,00	68	0,080	30,5		
10,00	65				
5,00	58				

SAMBLE IDENTIFICATION

Sample	10BH-04 (SS-10)
Depth	7,92 - 8,53 m
Soil Description	
Sandy silty gravel	

Prepared by Benoit St-Pierre, tech. **Approved by** Ibrahim Ja'far, ing. **Date** 2010-04-01

CLIENT	TransAlta	N/D G1-09-1532
PROJECT	Geotechnical study - Wind energy converters (WEC)	
LOCATION	St-Valentin, Québec	NO. LAB. 36373

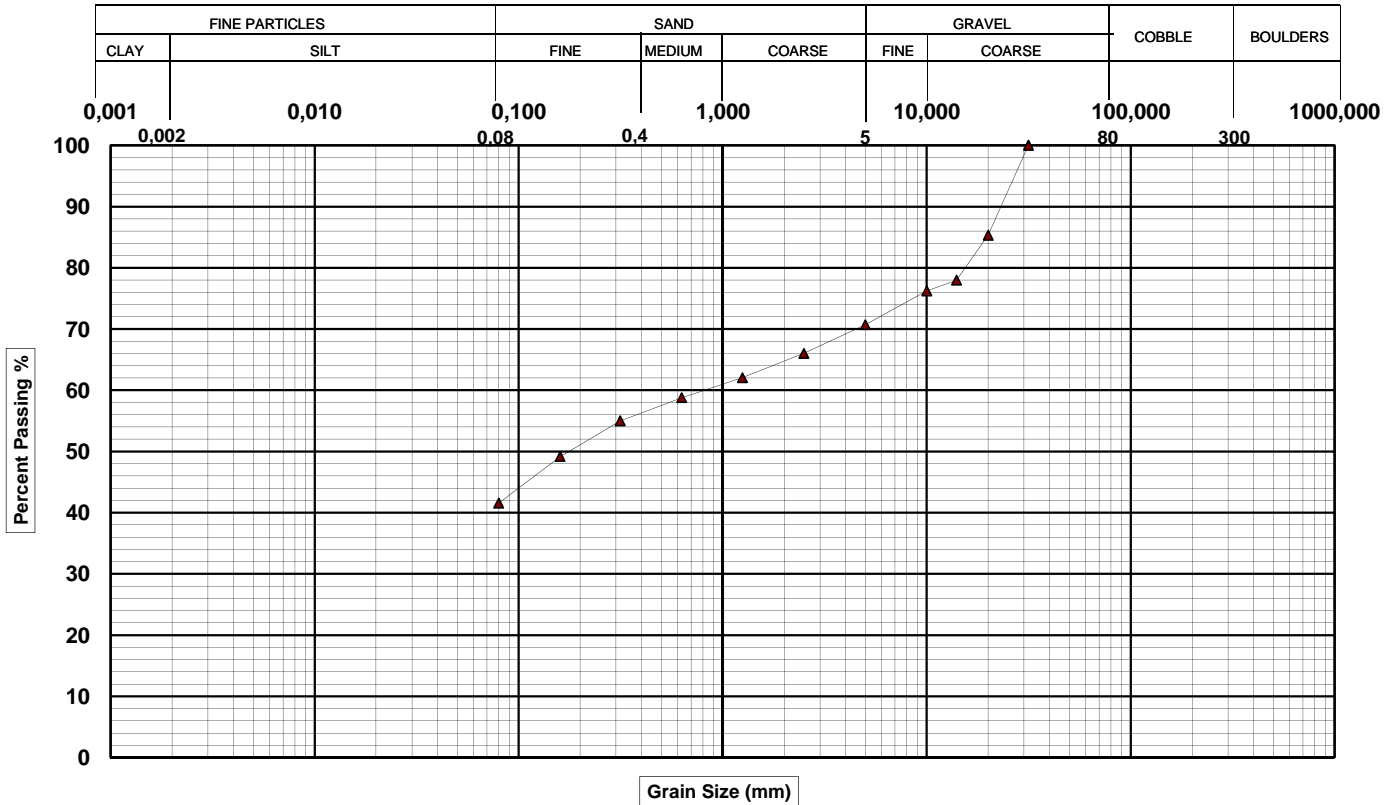

GRAIN-SIZE DISTRIBUTION					
Fine Particles		Coarse Particles			
Clay (%)	Silt (%)	Sand (%)	Gravel (%)	Cobble (%)	Boulder (%)
-	41,6	29,1	29,3	0,0	0,0

D₁₀ (mm)	D₃₀ (mm)	D₆₀ (mm)	C_u	C_c	W_n (%)
N/A	N/A	0,84	N/A	N/A	9

PERCENT PASSING					
(mm)	(%)	(mm)	(%)	(mm)	(%)
80,00	100	2,500	66		
56,00	100	1,250	62		
40,00	100	0,630	59		
31,50	100	0,315	55		
20,00	85	0,160	49		
14,00	78	0,080	41,6		
10,00	76				
5,00	71				

SAMBLE IDENTIFICATION	
Sample	10BH-12 (SS-10)
Depth	8,53 - 9,14 m
Soil Description	
Gravelly sandy Silt	

Prepared by Benoit St-Pierre, tech. Approved by Ibrahim Ja'far, ing. Date 2010-04-01

CLIENT TransAlta **N/D** G1-09-1532
PROJECT Geotechnical study - Wind energy converters (WEC)
LOCATION St-Valentin, Québec **NO. LAB.** 36375

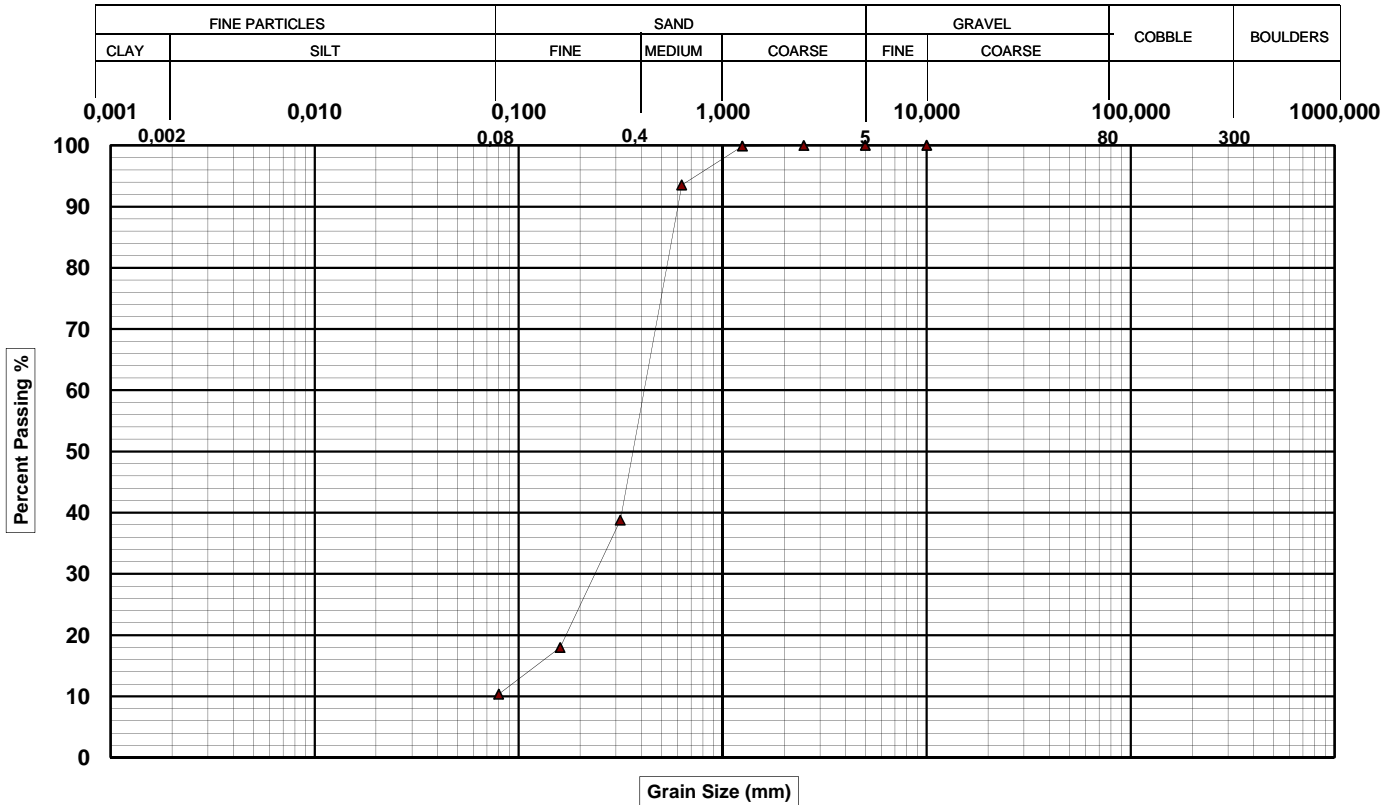

CLIENT	TransAlta	N/D G1-09-1532
PROJECT	Geotechnical study - Wind energy converters (WEC)	
LOCATION	St-Valentin, Québec	NO. LAB. 36376

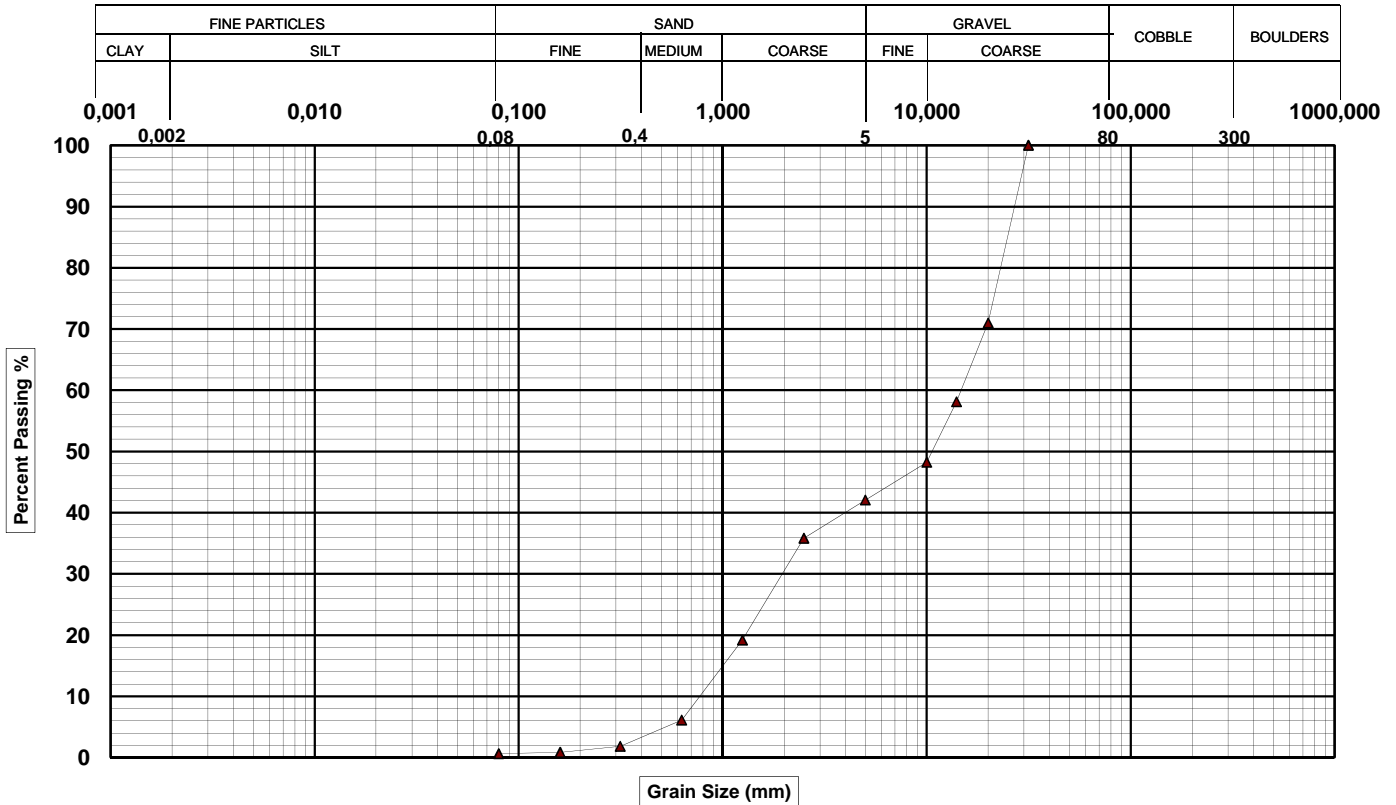

GRAIN-SIZE DISTRIBUTION					
Fine Particles			Coarse Particles		
Clay (%)	Silt (%)	Sand (%)	Gravel (%)	Cobble (%)	Boulder (%)
-	0,6	41,4	57,9	0,0	0,0

D₁₀ (mm)	D₃₀ (mm)	D₆₀ (mm)	C_u	C_c	W_n (%)
0,800	2,00	16,00	20,00	0,31	10

PERCENT PASSING					
(mm)	(%)	(mm)	(%)	(mm)	(%)
80,00	100	2,500	36		
56,00	100	1,250	19		
40,00	100	0,630	6		
31,50	100	0,315	2		
20,00	71	0,160	1		
14,00	58	0,080	0,6		
10,00	48				
5,00	42				

SAMBLE IDENTIFICATION	
Sample	10BH-14 (SS-11)
Depth	8,53 - 9,14 m
Soil Description	
Gravel and sand	

Prepared by Benoit St-Pierre, tech. Approved by Ibrahim Ja'far, ing. Date 2010-04-01

CLIENT TransAlta **N/D** G1-09-1532
PROJECT Geotechnical study - Wind energy converters (WEC)
LOCATION St-Valentin (Québec) **NO. LAB.** 36422

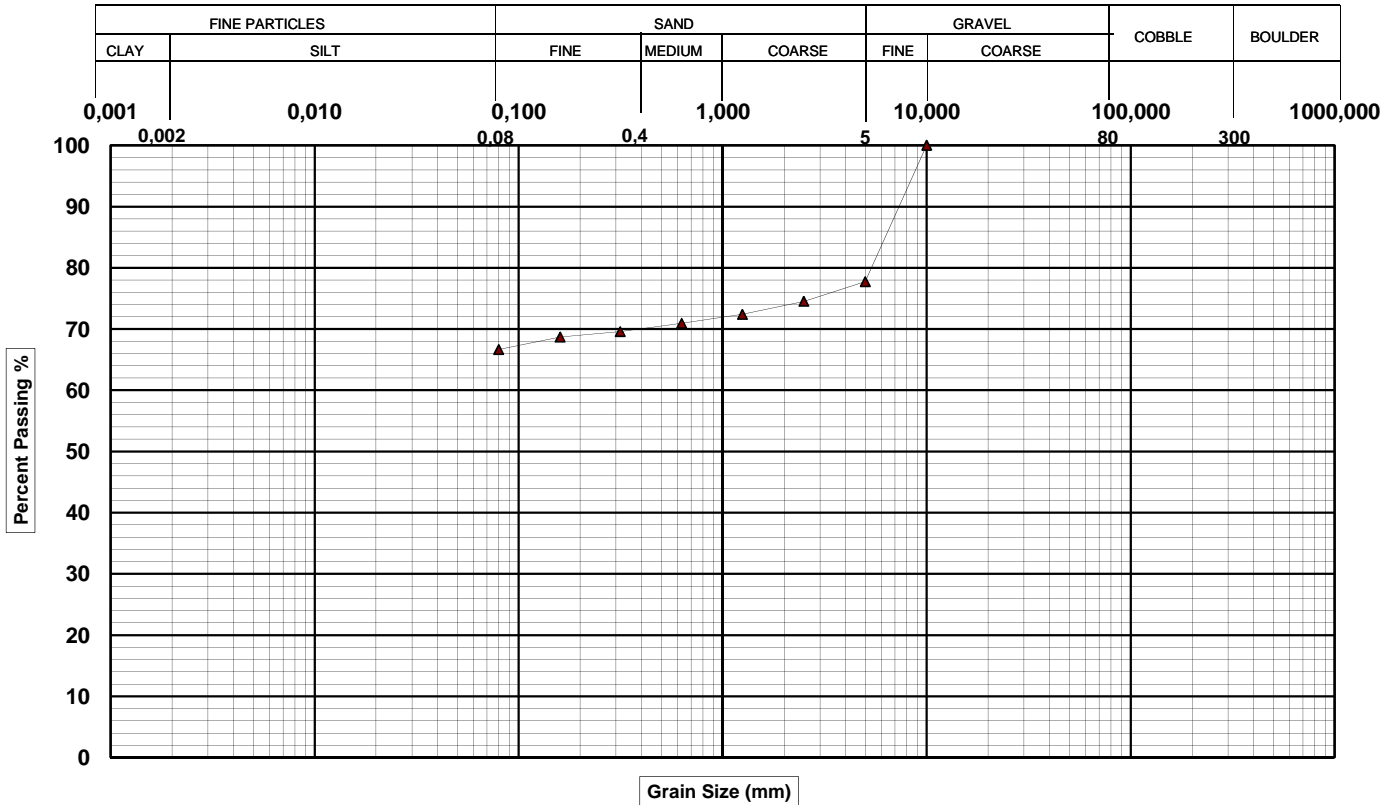

GRAIN-SIZE DISTRIBUTION					
Fine Particles		Coarse Particles			
Clay (%)	Silt (%)	Sand (%)	Gravel (%)	Cobble (%)	Boulder (%)
-	66,7	11,1	22,3	0,0	0,0

D ₁₀ (mm)	D ₃₀ (mm)	D ₆₀ (mm)	C _u	C _c	W _n (%)
N/A	N/A	N/A	N/A	N/A	15

PERCENT PASSING					
(mm)	(%)	(mm)	(%)	(mm)	(%)
80,00	100	2,500	75		
56,00	100	1,250	72		
40,00	100	0,630	71		
31,50	100	0,315	70		
20,00	100	0,160	69		
14,00	100	0,080	66,7		
10,00	100				
5,00	78				

SAMBLE IDENTIFICATION	
Sample	10BH-06 (SS-11)
Depth	8,84 - 9,45 m
Soil Description	
Silt, some gravel and sand	

Prepared by Benoit St-Pierre **Approved by** Ibrahim Ja'far, ing. **Date** 2010-04-08

CLIENT TransAlta **N/D** G1-09-1532
PROJECT Geotechnical study - Wind energy converters (WEC)
LOCATION St-Valentin (Québec) **NO. LAB.** 36426

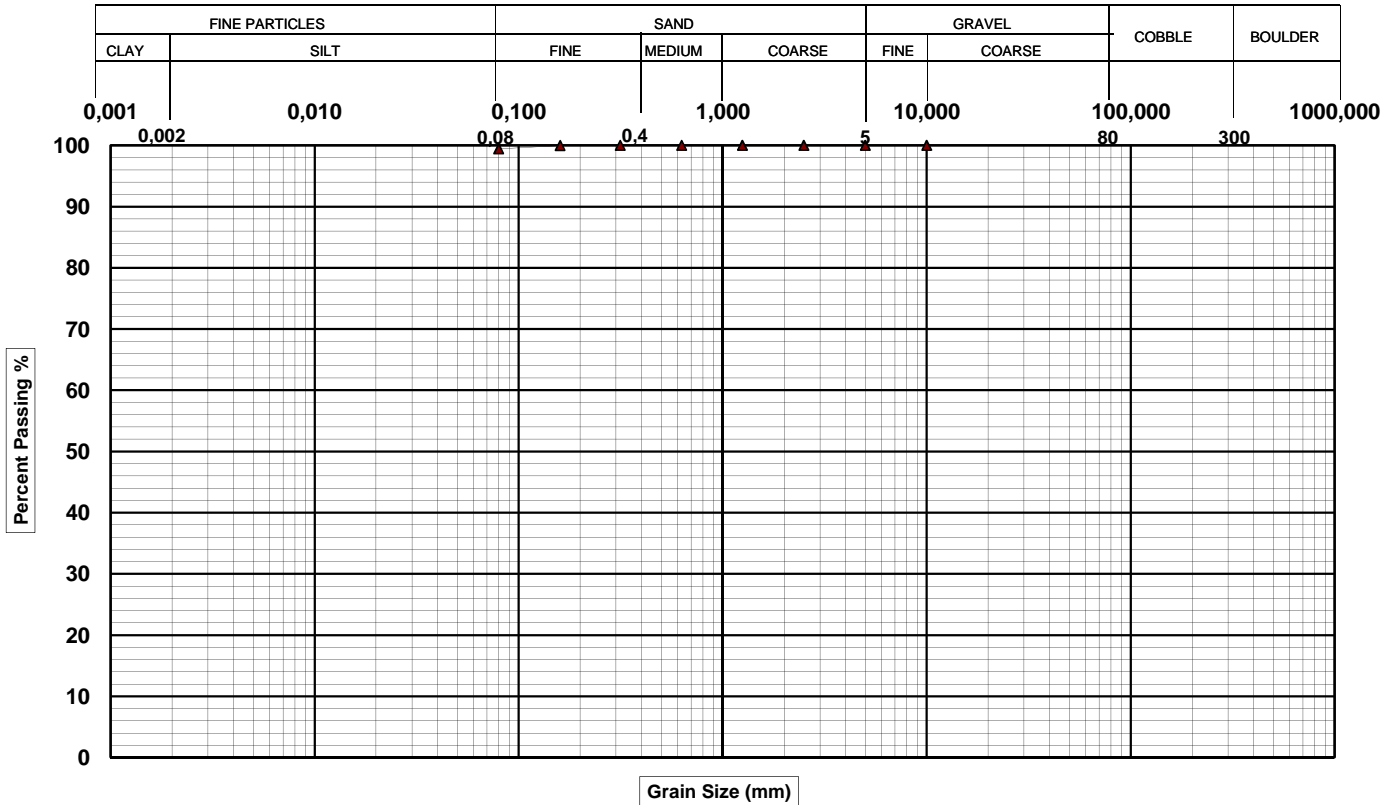

GRAIN-SIZE DISTRIBUTION					
Fine Particles		Coarse Particles			
Clay (%)	Silt (%)	Sand (%)	Gravel (%)	Cobble (%)	Boulder (%)
-	99,4	0,6	0,0	0,0	0,0

D ₁₀ (mm)	D ₃₀ (mm)	D ₆₀ (mm)	C _u	C _c	W _n (%)
N/A	N/A	N/A	N/A	N/A	12

PERCENT PASSING					
(mm)	(%)	(mm)	(%)	(mm)	(%)
80,00	100	2,500	100		
56,00	100	1,250	100		
40,00	100	0,630	100		
31,50	100	0,315	100		
20,00	100	0,160	100		
14,00	100	0,080	99,4		
10,00	100				
5,00	100				

SAMBLE IDENTIFICATION	
Sample	10BH-11 (SS-05)
Depth	3,05 - 3,66 m
Soil Description	
Silt	

Prepared by Benoit St-Pierre **Approved by** Ibrahim Ja'far, ing. **Date** 2010-04-08

CLIENT TransAlta **N/D** G1-09-1532
PROJECT Geotechnical study - Wind energy converters (WEC)
LOCATION St-Valentin (Québec) **NO. LAB.** 36427

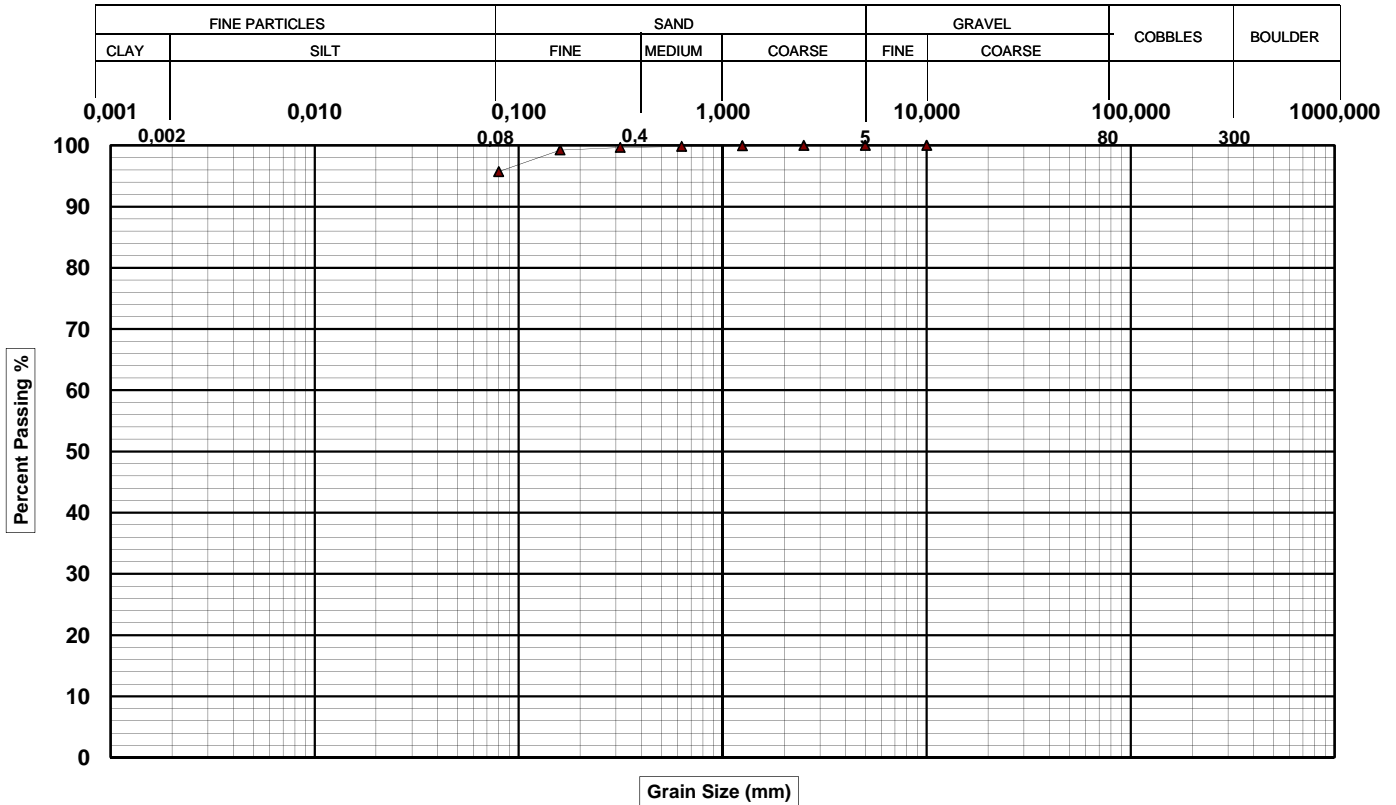

GRAIN-SIZE DISTRIBUTION					
Fine Particles		Coarse Particles			
Clay (%)	Silt (%)	Sand (%)	Gravel (%)	Cobble (%)	Boulder (%)
-	95,7	4,3	0,0	0,0	0,0

D ₁₀ (mm)	D ₃₀ (mm)	D ₆₀ (mm)	C _u	C _c	W _n (%)
N/A	N/A	N/A	N/A	N/A	18

PERCENT PASSING					
(mm)	(%)	(mm)	(%)	(mm)	(%)
80,00	100	2,500	100		
56,00	100	1,250	100		
40,00	100	0,630	100		
31,50	100	0,315	100		
20,00	100	0,160	99		
14,00	100	0,080	95,7		
10,00	100				
5,00	100				

SAMBLE IDENTIFICATION	
Sample	10BH-11 (SS-11)
Depth	8,53 - 9,14 m
Soil Description	
Silt, traces of sand	

Prepared by Benoit St-Pierre **Approved by** Ibrahim Ja'far, ing. **Date** 2010-04-08

CLIENT	TransAlta	N/D G1-09-1532
PROJECT	Geotechnical study - Wind energy converters (WEC)	
LOCATION	St-Valentin (Québec)	NO. LAB. 36421

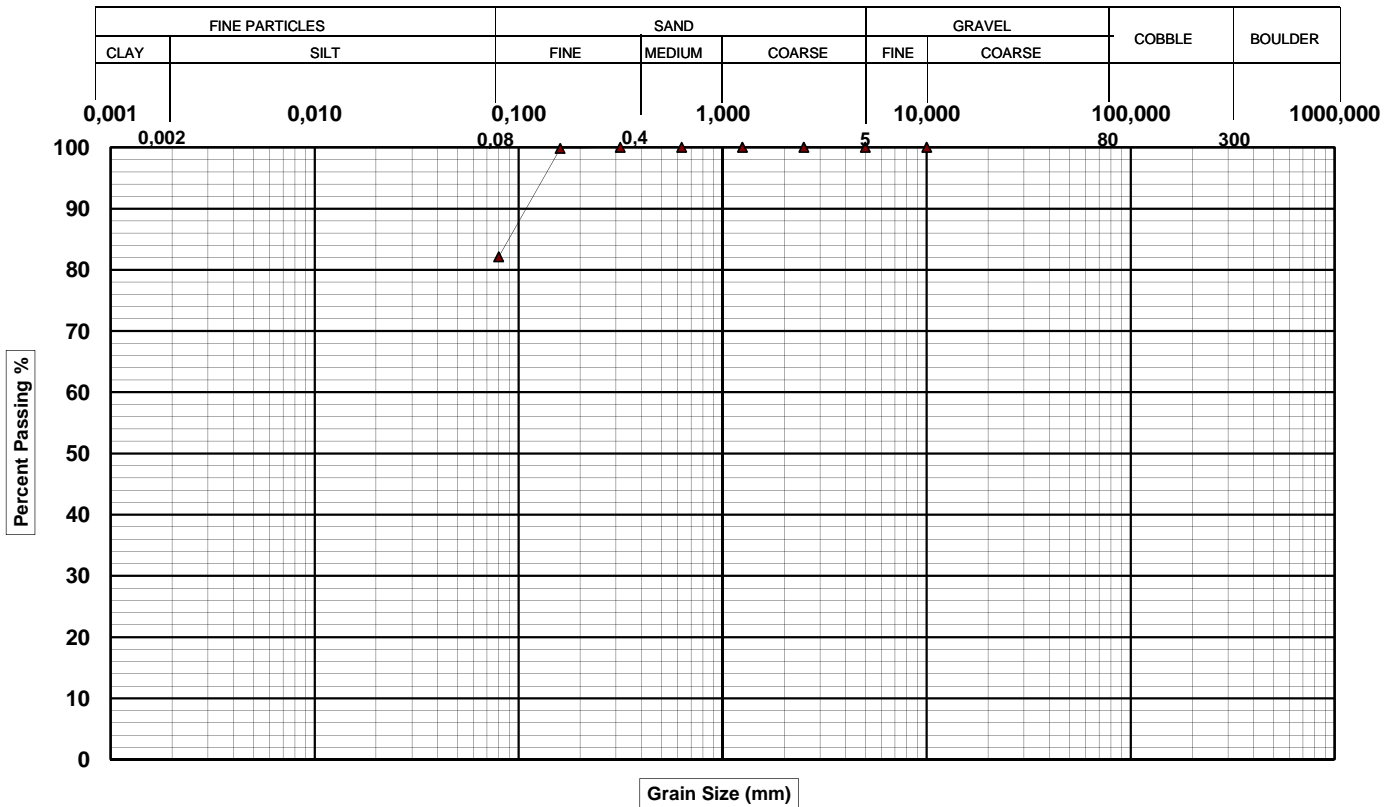

GRAIN-SIZE DISTRIBUTION					
Fine Particles		Coarse Particles			
Clay (%)	Silt (%)	Sand (%)	Gravel (%)	Cobble (%)	Boulder (%)
-	82,1	17,9	0,0	0,0	0,0

D ₁₀ (mm)	D ₃₀ (mm)	D ₆₀ (mm)	C _u	C _c	W _n (%)
N/A	N/A	N/A	N/A	N/A	19

PERCENT PASSING					
(mm)	(%)	(mm)	(%)	(mm)	(%)
80,00	100	2,500	100		
56,00	100	1,250	100		
40,00	100	0,630	100		
31,50	100	0,315	100		
20,00	100	0,160	100		
14,00	100	0,080	82,1		
10,00	100				
5,00	100				

SAMBLE IDENTIFICATION	
Sample	10BH-06 (SS-06)
Depth	4,27 - 4,88 m
Soil Description	
Silt, some sand	

Prepared by Benoit St-Pierre	Approved by Ibrahim Ja'far, ing.	Date 2010-04-08
-------------------------------------	---	------------------------

CLIENT TransAlta **N/D** G1-09-1532
PROJECT Geotechnical study - Wind energy converters (WEC)
LOCATION St-Valentin (Québec) **NO. LAB.** 36431

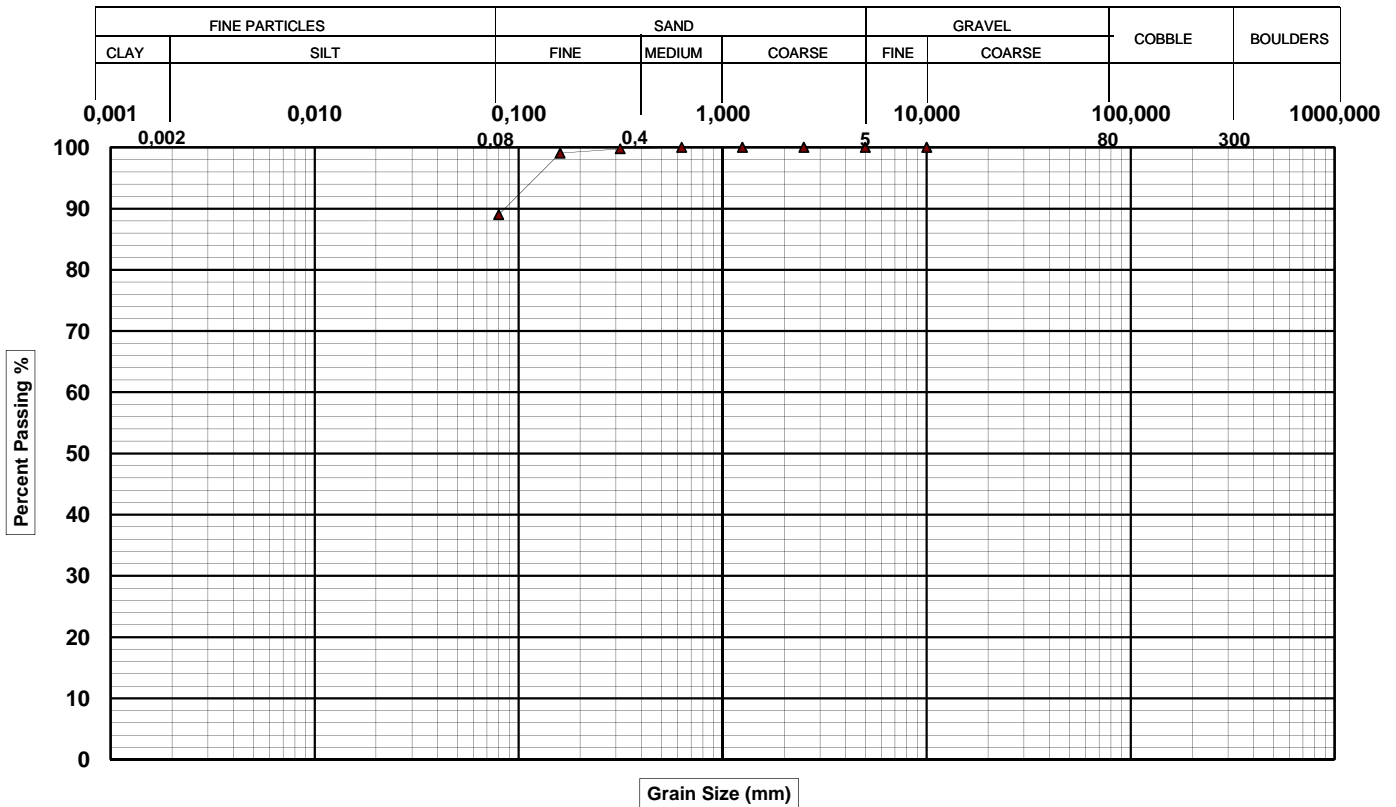

GRAIN-SIZE DISTRIBUTION					
Fine Particles		Coarse Particles			
Clay (%)	Silt (%)	Sand (%)	Gravel (%)	Cobble (%)	Boulder (%)
-	89,0	11,0	0,0	0,0	0,0

D ₁₀ (mm)	D ₃₀ (mm)	D ₆₀ (mm)	C _u	C _c	W _n (%)
N/A	N/A	N/A	N/A	N/A	16

PERCENT PASSING					
(mm)	(%)	(mm)	(%)	(mm)	(%)
80,00	100	2,500	100		
56,00	100	1,250	100		
40,00	100	0,630	100		
31,50	100	0,315	100		
20,00	100	0,160	99		
14,00	100	0,080	89,0		
10,00	100				
5,00	100				

SAMBLE IDENTIFICATION	
Sample	10BH-08 (SS-12)
Depth	9,75 - 10,36 m
Soil Description	
Silt, some sand	

Prepared by Benoit St-Pierre **Approved by** Ibrahim Ja'far, ing. **Date** 2010-04-08

CLIENT TransAlta **N/D** G1-09-1532
PROJECT Geotechnical study - Wind energy converters (WEC)
LOCATION St-Valentin (Québec) **NO. LAB.** 36434

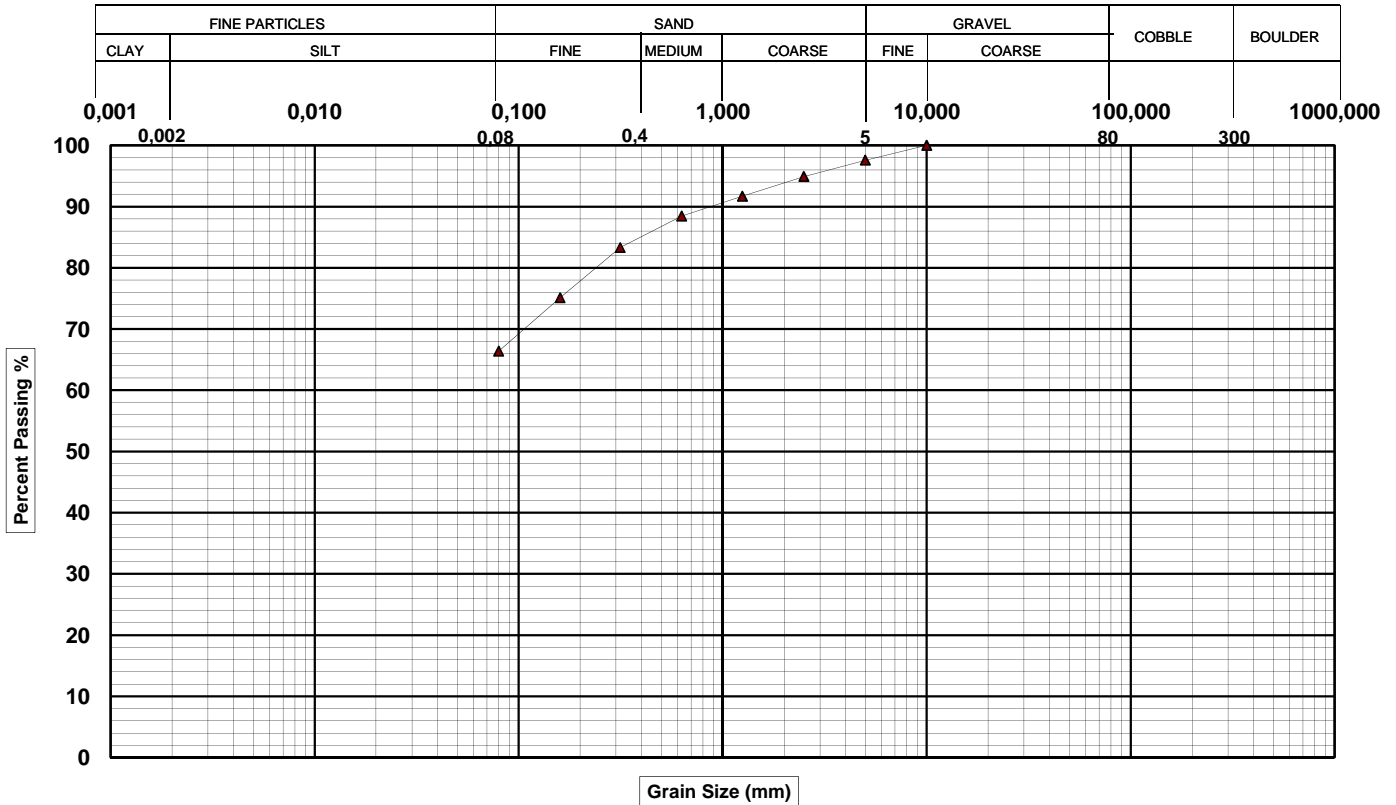

GRAIN-SIZE DISTRIBUTION					
Fine Particles		Coarse Particles			
Clay (%)	Silt (%)	Sand (%)	Gravel (%)	Cobble (%)	Boulder (%)
-	66,4	31,2	2,4	0,0	0,0

D ₁₀ (mm)	D ₃₀ (mm)	D ₆₀ (mm)	C _u	C _c	W _n (%)
N/A	N/A	N/A	N/A	N/A	13

PERCENT PASSING					
(mm)	(%)	(mm)	(%)	(mm)	(%)
80,00	100	2,500	95		
56,00	100	1,250	92		
40,00	100	0,630	88		
31,50	100	0,315	83		
20,00	100	0,160	75		
14,00	100	0,080	66,4		
10,00	100				
5,00	98				

SAMBLE IDENTIFICATION	
Sample	10BH-13 (SS-09)
Depth	7,01 - 7,62 m
Soil Description	
Sandy silt, traces of gravel	

Prepared by Benoit St-Pierre **Approved by** Ibrahim Ja'far, ing. **Date** 2010-04-08

CLIENT	TransAlta	N/D G1-09-1532
PROJECT	Geotechnical study - Wind energy converters (WEC)	
LOCATION	St-Valentin (Québec)	NO. LAB. 36435

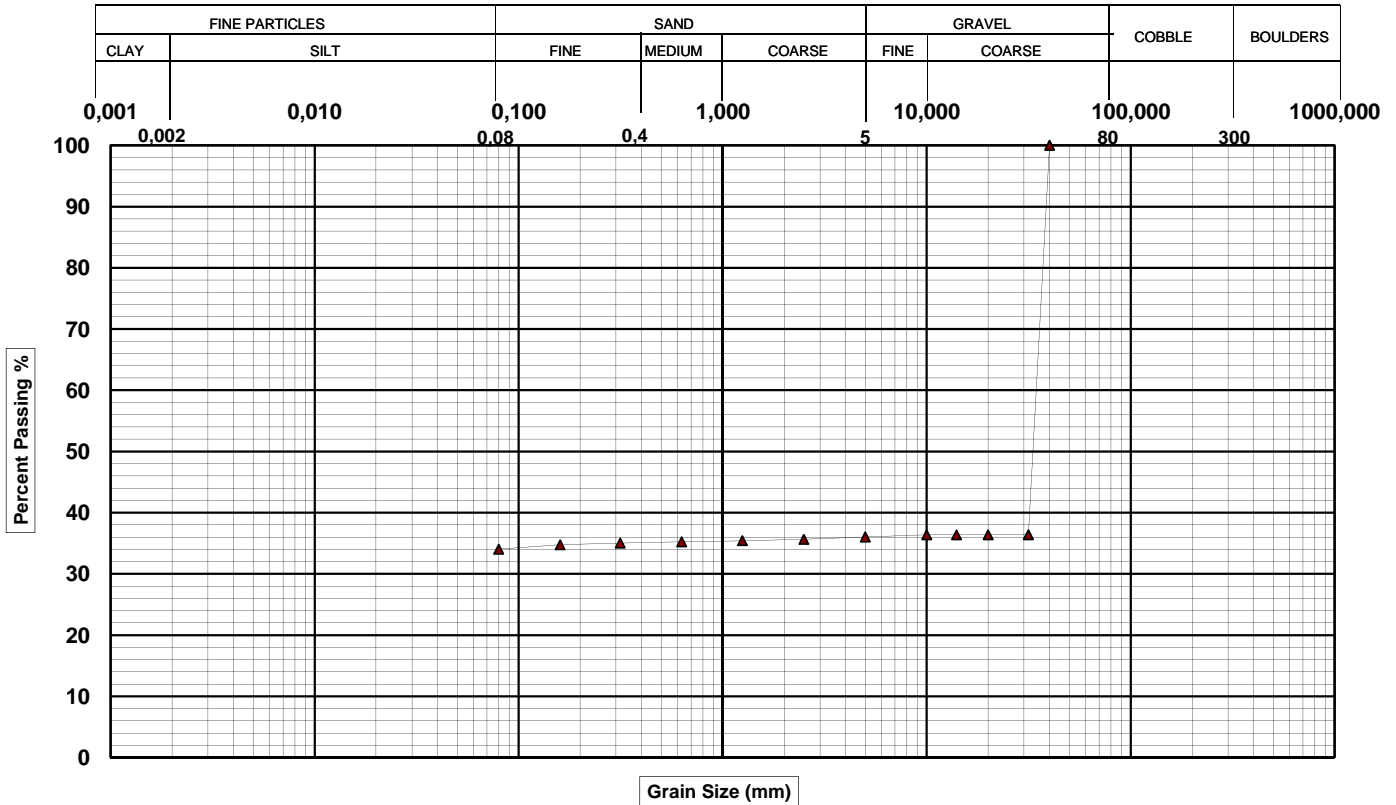

GRAIN-SIZE DISTRIBUTION					
Fine Particles		Coarse Particles			
Clay (%)	Silt (%)	Sand (%)	Gravel (%)	Cobble (%)	Boulder (%)
-	34,0	2,0	64,0	0,0	0,0

D ₁₀ (mm)	D ₃₀ (mm)	D ₆₀ (mm)	C _u	C _c	W _n (%)
N/A	N/A	N/A	N/A	N/A	7

PERCENT PASSING					
(mm)	(%)	(mm)	(%)	(mm)	(%)
80,00	100	2,500	36		
56,00	100	1,250	35		
40,00	100	0,630	35		
31,50	36	0,315	35		
20,00	36	0,160	35		
14,00	36	0,080	34,0		
10,00	36				
5,00	36				

SAMBLE IDENTIFICATION	
Sample	10F-13 (CF-13)
Depth	10,67 - 11,28 m
Soil Description	
Gravel silteux, traces of sand	

Prepared by Benoit St-Pierre	Approved by Ibrahim Ja'far, ing.	Date 2010-04-08
-------------------------------------	---	------------------------

CLIENT	TransAlta	N/D G1-09-1532
PROJECT	Geotechnical study - Wind energy converters (WEC)	
LOCATION	St-Valentin (Québec)	NO. LAB. 34633

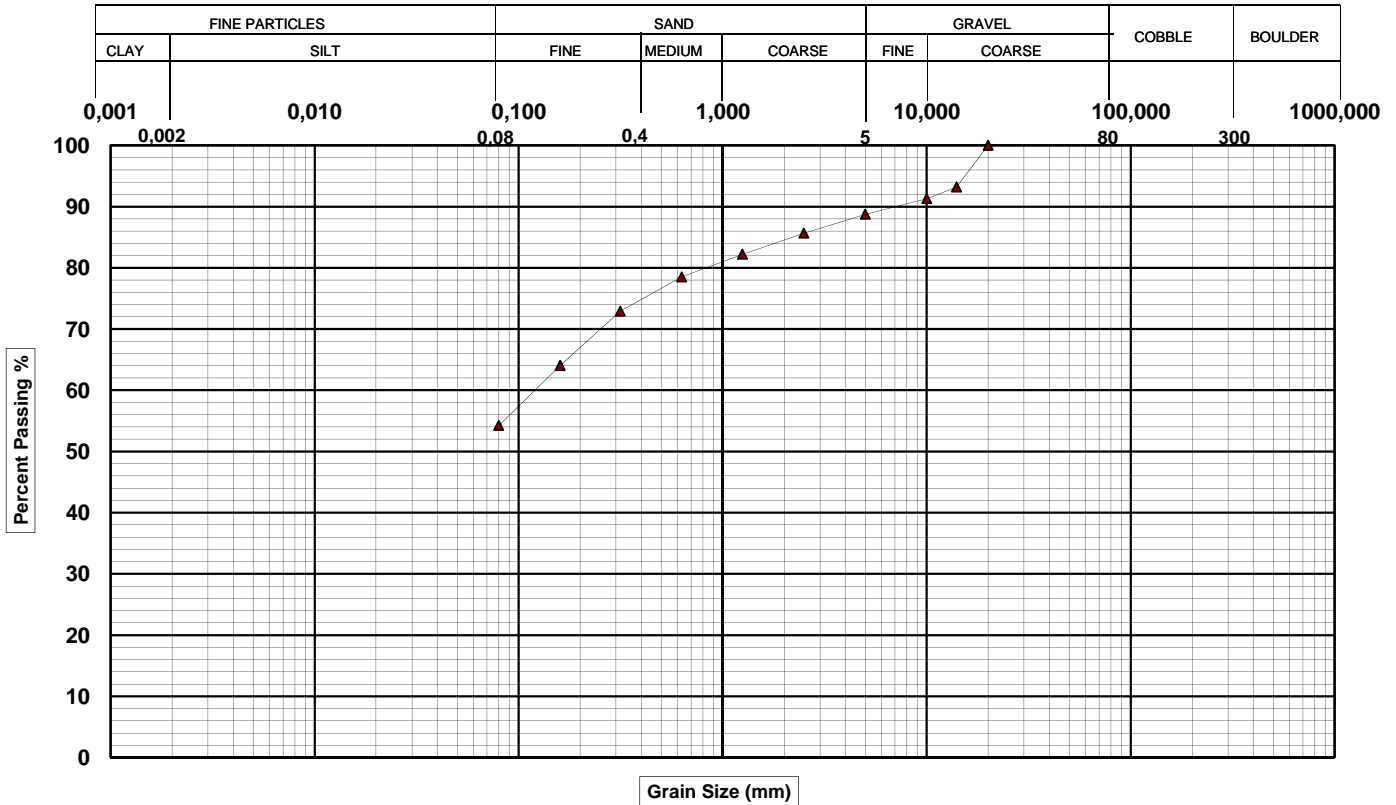

GRAIN-SIZE DISTRIBUTION					
Fine Particles		Coarse Particles			
Clay (%)	Silt (%)	Sand (%)	Gravel (%)	Cobble (%)	Boulder (%)
-	54,2	34,5	11,3	0,0	0,0

D ₁₀ (mm)	D ₃₀ (mm)	D ₆₀ (mm)	C _u	C _c	W _n (%)
N/A	N/A	0,12	N/A	N/A	10

PERCENT PASSING					
(mm)	(%)	(mm)	(%)	(mm)	(%)
80,00	100	2,500	86		
56,00	100	1,250	82		
40,00	100	0,630	79		
31,50	100	0,315	73		
20,00	100	0,160	64		
14,00	93	0,080	54,2		
10,00	91				
5,00	89				

SAMBLE IDENTIFICATION	
Sample	10BH-13 (SS-05)
Depth	3,35 - 3, 96 m
Soil Description	
Sandy silt, some gravel	

Prepared by Benoit St-Pierre	Approved by Ibrahim Ja'far, ing.	Date 2010-04-08
-------------------------------------	---	------------------------

CLIENT TransAlta **N/D** G1-09-1532
PROJECT Geotechnical study - Wind energy converters (WEC)
LOCATION St-Valentin (Québec) **NO. LAB.** 36432

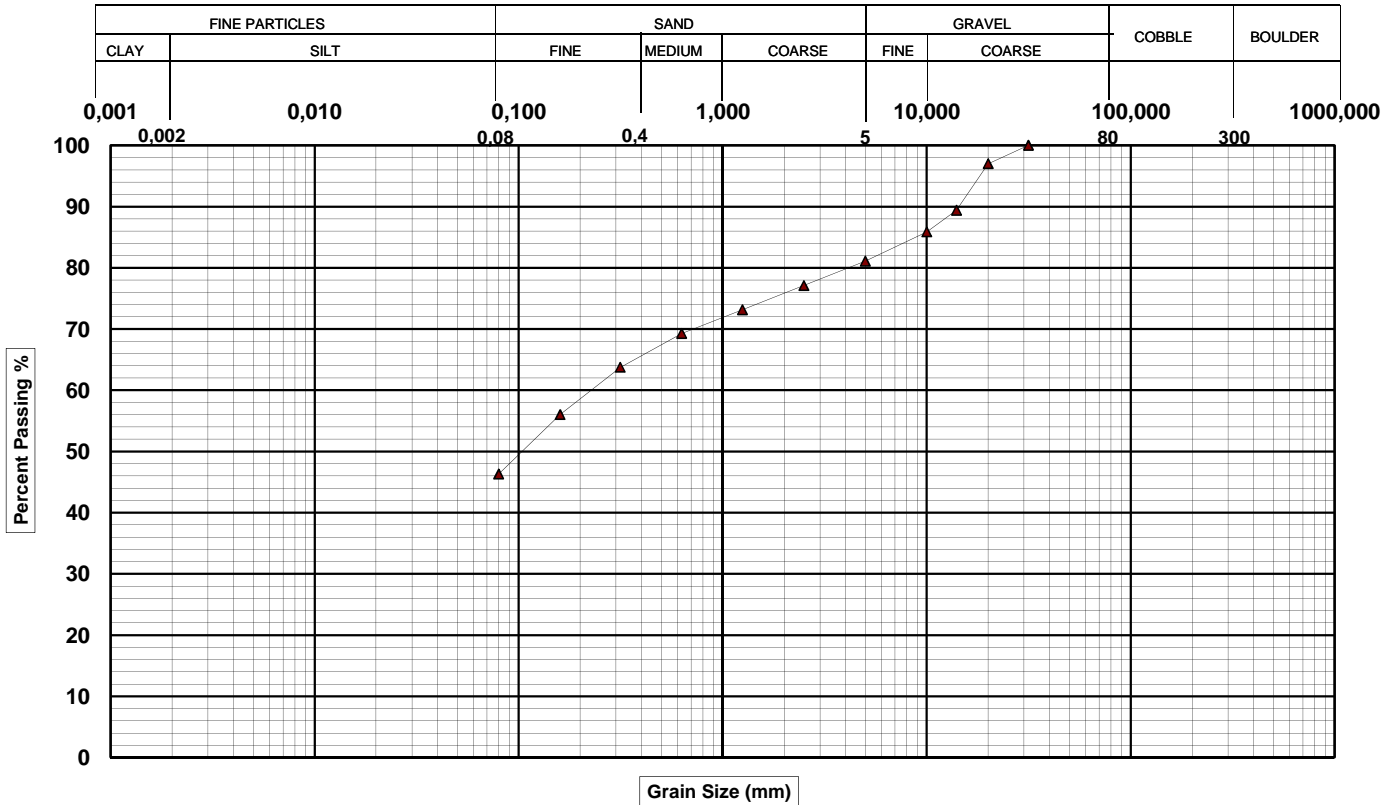

GRAIN-SIZE DISTRIBUTION					
Fine Particles		Coarse Particles			
Clay (%)	Silt (%)	Sand (%)	Gravel (%)	Cobble (%)	Boulder (%)
-	46,3	34,8	18,9	0,0	0,0

D₁₀ (mm)	D₃₀ (mm)	D₆₀ (mm)	C_u	C_c	W_n (%)
N/A	N/A	0,23	N/A	N/A	8

PERCENT PASSING					
(mm)	(%)	(mm)	(%)	(mm)	(%)
80,00	100	2,500	77		
56,00	100	1,250	73		
40,00	100	0,630	69		
31,50	100	0,315	64		
20,00	97	0,160	56		
14,00	89	0,080	46,3		
10,00	86				
5,00	81				

SAMBLE IDENTIFICATION	
Sample	10BH-08 (SS-16)
Depth	15,00 - 15,61 m
Soil Description	
Sandy silt, some gravel	

Prepared by Benoit St-Pierre **Approved by** Ibrahim Ja'far, ing. **Date** 2010-04-08

CLIENT TransAlta **N/D** G1-09-1532
PROJECT Geotechnical study - Wind energy converters (WEC)
LOCATION St-Valentin (Québec) **NO. LAB.** 36436

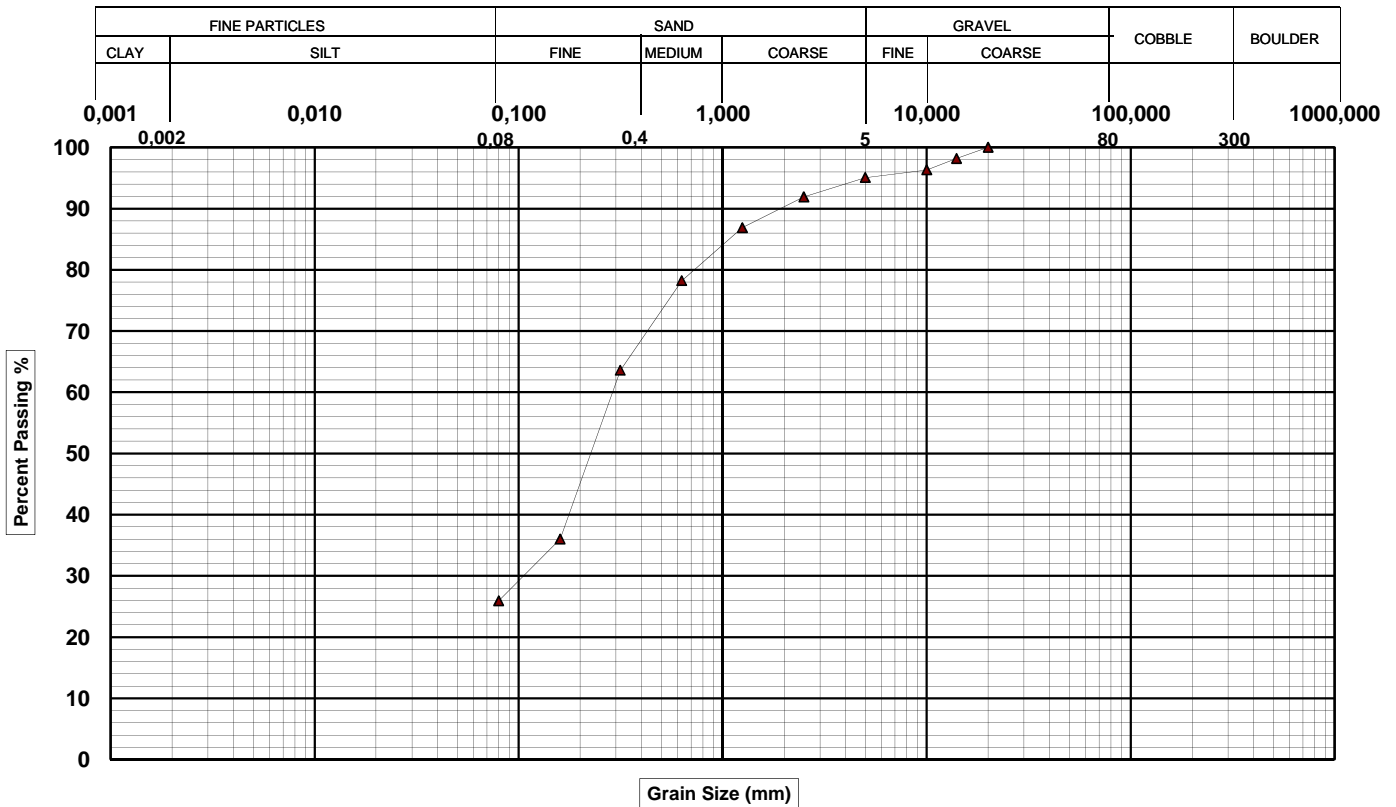

GRAIN-SIZE DISTRIBUTION					
Fine Particles		Coarse Particles			
Clay (%)	Silt (%)	Sand (%)	Gravel (%)	Cobble (%)	Boulder (%)
-	25,9	69,1	4,9	0,0	0,0

D₁₀ (mm)	D₃₀ (mm)	D₆₀ (mm)	C_u	C_c	W_n (%)
N/A	0,10	0,30	N/A	N/A	16

PERCENT PASSING					
(mm)	(%)	(mm)	(%)	(mm)	(%)
80,00	100	2,500	92		
56,00	100	1,250	87		
40,00	100	0,630	78		
31,50	100	0,315	64		
20,00	100	0,160	36		
14,00	98	0,080	25,9		
10,00	96				
5,00	95				

SAMBLE IDENTIFICATION	
Sample	10BH-13 (SS-16)
Depth	15,24 - 15,85 m
Soil Description	
Silty sand, traces of gravel	

Prepared by Benoit St-Pierre **Approved by** Ibrahim Ja'far, ing. **Date** 2010-04-08

CLIENT TransAlta **N/D** G1-09-1532
PROJECT Geotechnical study - Wind energy converters (WEC)
LOCATION St-Valentin (Québec) **NO. LAB.** 36424

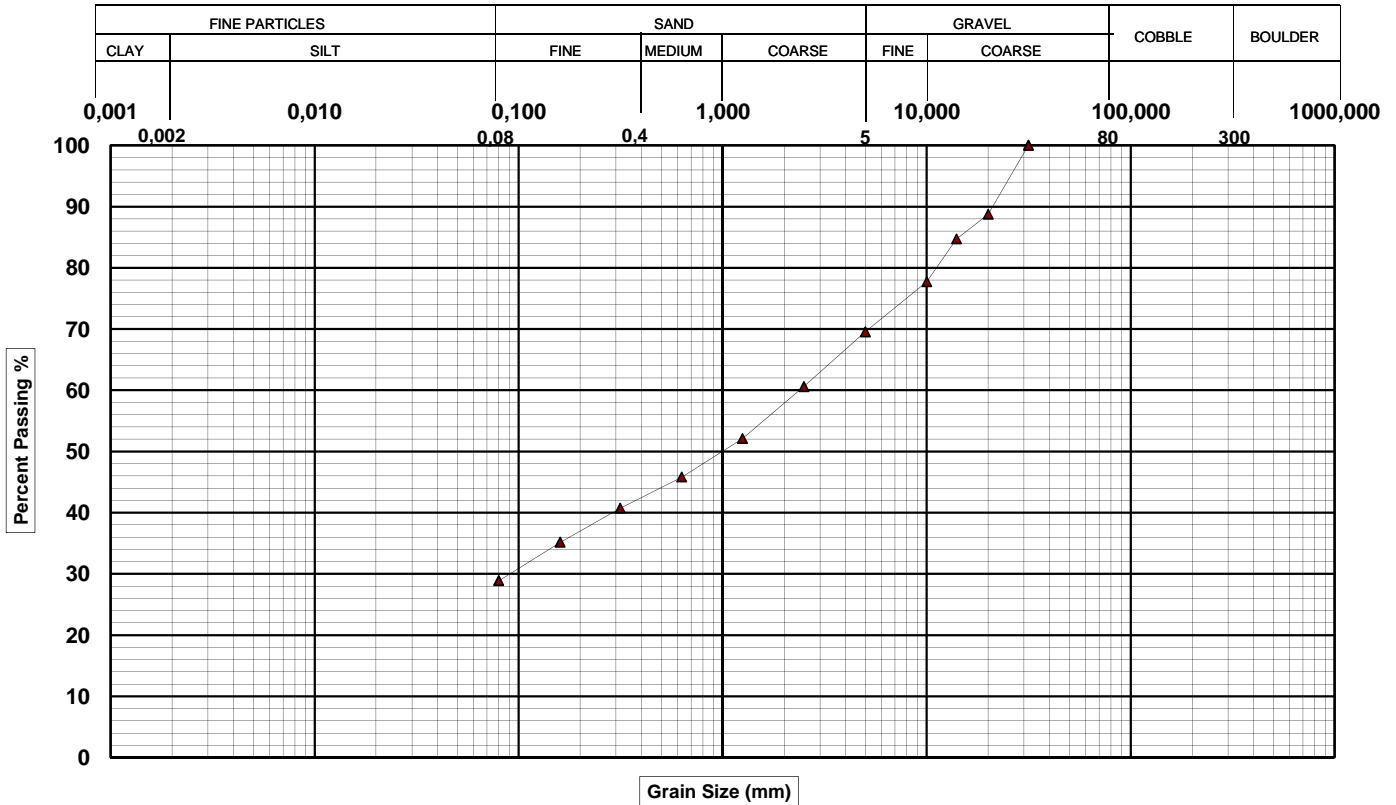

GRAIN-SIZE DISTRIBUTION

Fine Particles		Coarse Particles			
Clay (%)	Silt (%)	Sand (%)	Gravel (%)	Cobble (%)	Boulder (%)
-	28,9	40,6	30,5	0,0	0,0

D₁₀ (mm)	D₃₀ (mm)	D₆₀ (mm)	C_u	C_c	W_n (%)
N/A	0,09	0,25	N/A	N/A	8

PERCENT PASSING

(mm)	(%)	(mm)	(%)	(mm)	(%)
80,00	100	2,500	61		
56,00	100	1,250	52		
40,00	100	0,630	46		
31,50	100	0,315	41		
20,00	89	0,160	35		
14,00	85	0,080	28,9		
10,00	78				
5,00	70				

SAMBLE IDENTIFICATION

Sample	10BH-07 (SS-07)
Depth	5,18 - 5,79 m
Soil Description	
Silty gravelly sand	

Prepared by Benoit St-Pierre **Approved by** Ibrahim Ja'far, ing. **Date** 2010-04-08

CLIENT TransAlta **N/D** G1-09-1532
PROJECT Geotechnical study - Wind energy converters (WEC)
LOCATION St-Valentin (Québec) **NO. LAB.** 36429

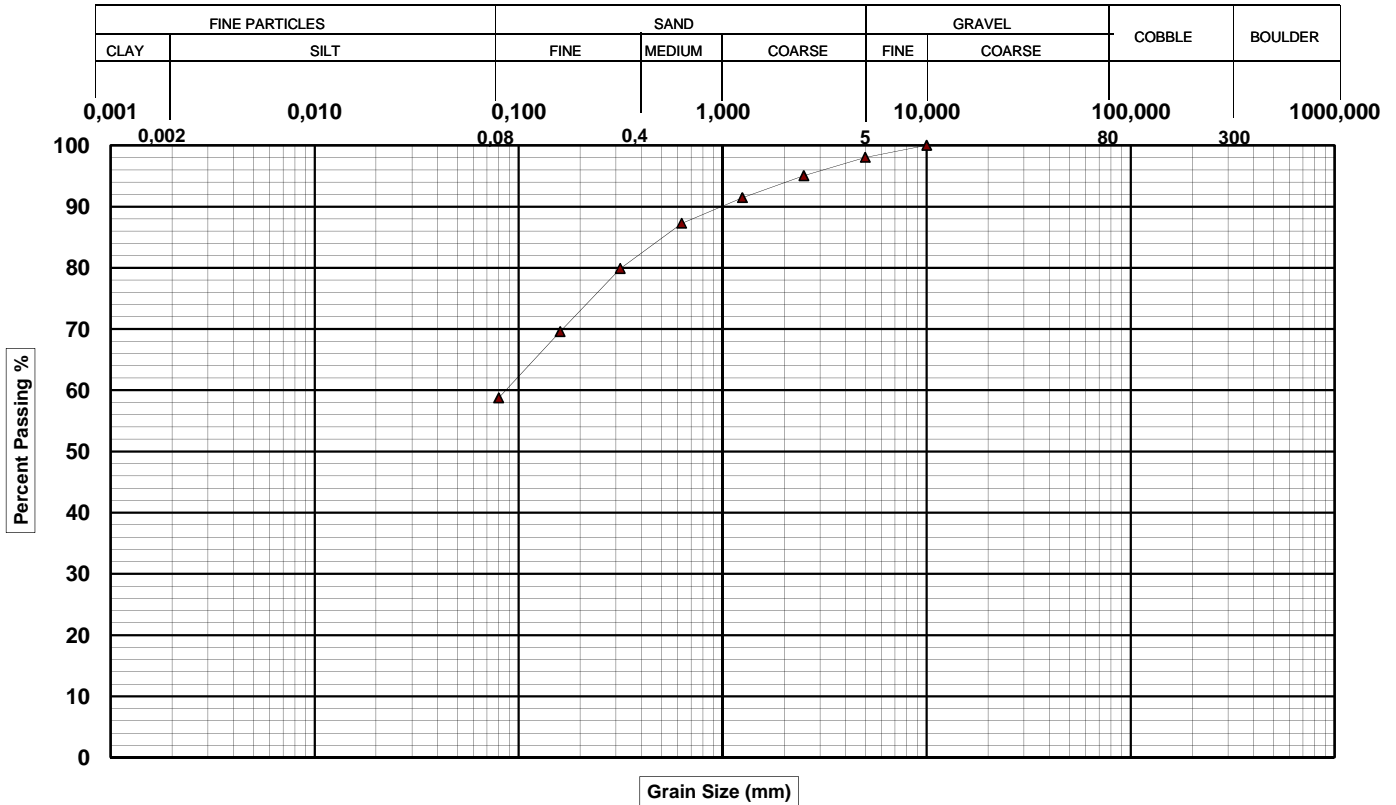

GRAIN-SIZE DISTRIBUTION					
Fine Particles		Coarse Particles			
Clay (%)	Silt (%)	Sand (%)	Gravel (%)	Cobble (%)	Boulder (%)
-	58,7	39,3	2,0	0,0	0,0

D₁₀ (mm)	D₃₀ (mm)	D₆₀ (mm)	C_u	C_c	W_n (%)
N/A	N/A	0,09	N/A	N/A	4

PERCENT PASSING					
(mm)	(%)	(mm)	(%)	(mm)	(%)
80,00	100	2,500	95		
56,00	100	1,250	91		
40,00	100	0,630	87		
31,50	100	0,315	80		
20,00	100	0,160	70		
14,00	100	0,080	58,7		
10,00	100				
5,00	98				

SAMBLE IDENTIFICATION	
Sample	10BH-08 (SS-04)
Depth	2,44 - 3,05 m
Soil Description	
Silt and sand, traces of gravel	

Prepared by Benoit St-Pierre **Approved by** Ibrahim Ja'far, ing. **Date** 2010-04-08

CLIENT	TransAlta	N/D G1-09-1532
PROJECT	Geotechnical study - Wind energy converters (WEC)	
LOCATION	St-Valentin (Québec)	NO. LAB. 36428

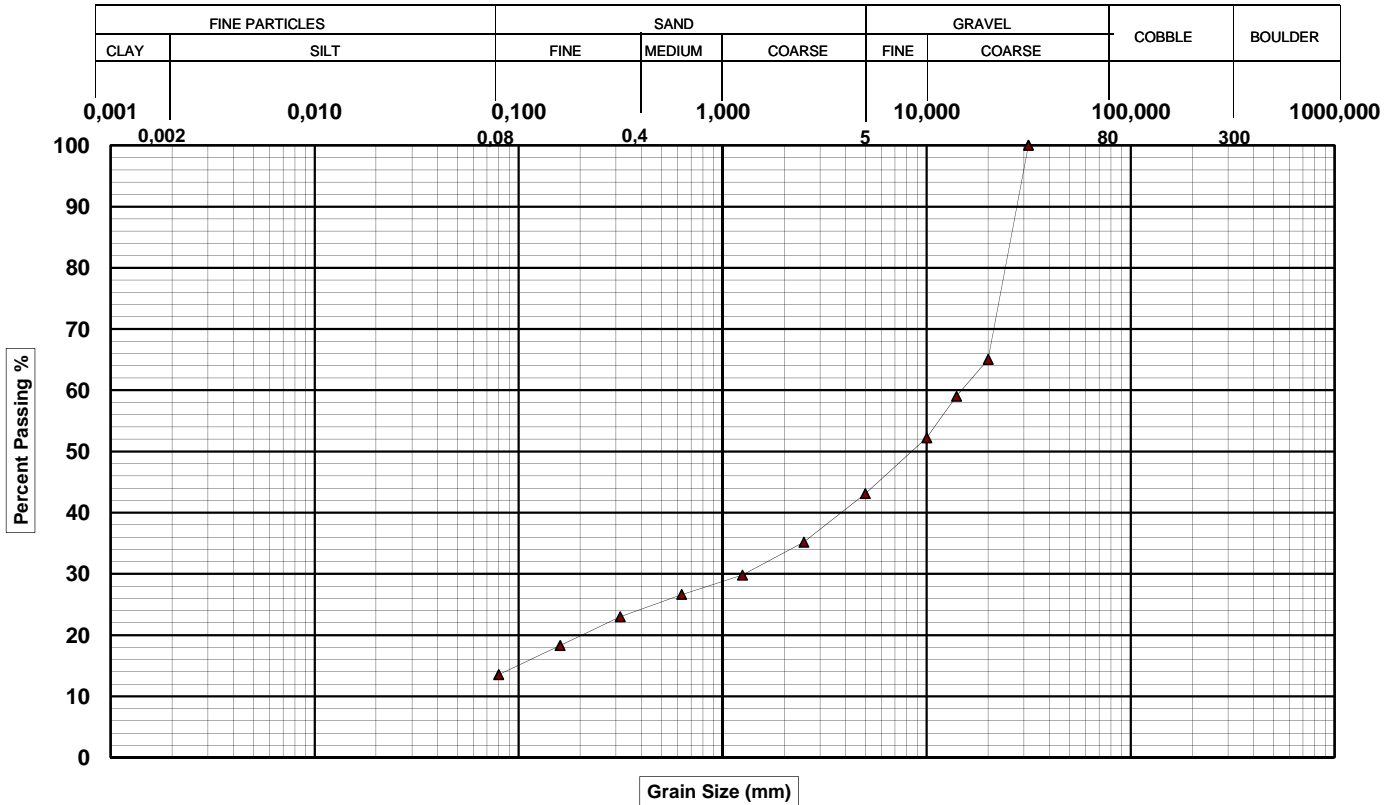

GRAIN-SIZE DISTRIBUTION					
Fine Particles		Coarse Particles			
Clay (%)	Silt (%)	Sand (%)	Gravel (%)	Cobble (%)	Boulder (%)
-	13,5	29,6	56,9	0,0	0,0

D ₁₀ (mm)	D ₃₀ (mm)	D ₆₀ (mm)	C _u	C _c	W _n (%)
N/A	1,40	N/A	N/A	N/A	6

PERCENT PASSING					
(mm)	(%)	(mm)	(%)	(mm)	(%)
80,00	100	2,500	35		
56,00	100	1,250	30		
40,00	100	0,630	27		
31,50	100	0,315	23		
20,00	65	0,160	18		
14,00	59	0,080	13,5		
10,00	52				
5,00	43				

SAMBLE IDENTIFICATION	
Sample	10BH-11 (SS-13)
Depth	10,67 - 11,28 m
Soil Description	
Sandy gravel, some silt	

Prepared by Benoit St-Pierre	Approved by Ibrahim Ja'far, ing.	Date 2010-04-08
-------------------------------------	---	------------------------

CLIENT TransAlta **N/D** G1-09-1532
PROJECT Geotechnical study - Wind energy converters (WEC)
LOCATION St-Valentin (Québec) **NO. LAB.** 36430

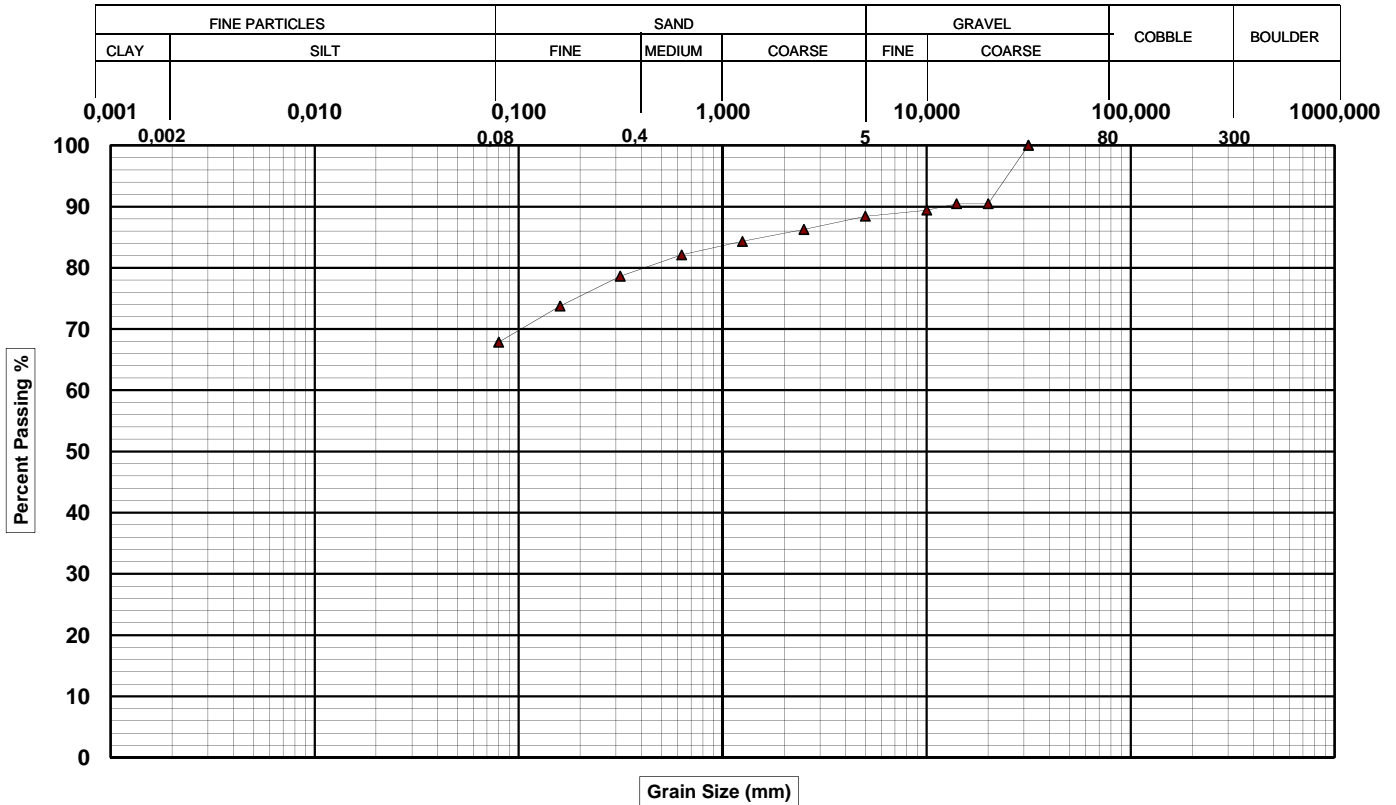

GRAIN-SIZE DISTRIBUTION					
Fine Particles		Coarse Particles			
Clay (%)	Silt (%)	Sand (%)	Gravel (%)	Cobble (%)	Boulder (%)
-	67,9	20,6	11,6	0,0	0,0

D₁₀ (mm)	D₃₀ (mm)	D₆₀ (mm)	C_u	C_c	W_n (%)
N/A	N/A	N/A	N/A	N/A	13

PERCENT PASSING					
(mm)	(%)	(mm)	(%)	(mm)	(%)
80,00	100	2,500	86		
56,00	100	1,250	84		
40,00	100	0,630	82		
31,50	100	0,315	79		
20,00	90	0,160	74		
14,00	90	0,080	67,9		
10,00	89				
5,00	88				

SAMBLE IDENTIFICATION	
Sample	10BH-08 (SS-09)
Depth	7,01 - 7,62 m
Soil Description	
Sandy silt, some gravel	

Prepared by Benoit St-Pierre **Approved by** Ibrahim Ja'far, ing. **Date** 2010-04-08

CLIENT TransAlta **N/D** G1-09-1532
PROJECT Geotechnical study - Wind energy converters (WEC)
LOCATION St-Valentin (Québec) **NO. LAB.** 36525

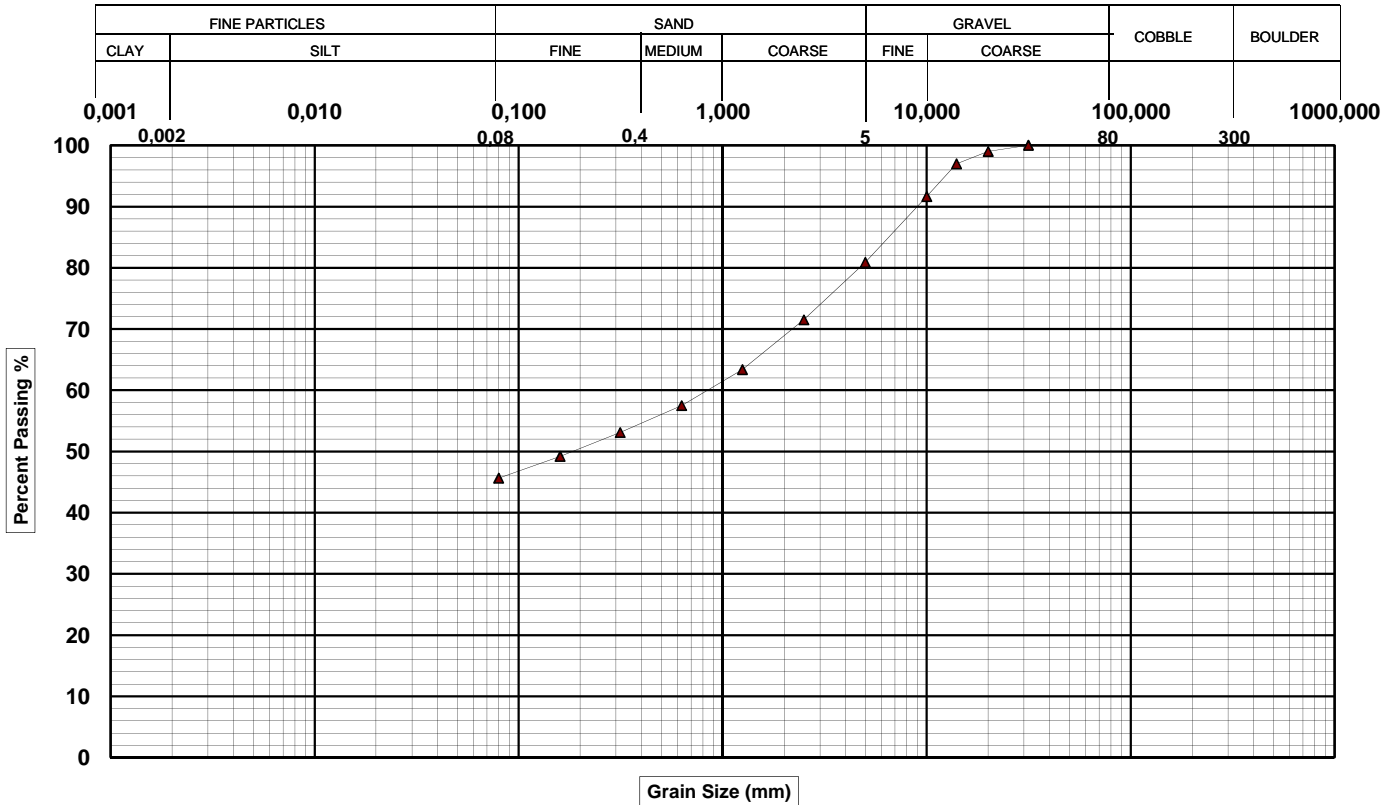

GRAIN-SIZE DISTRIBUTION					
Fine Particles		Coarse Particles			
Clay (%)	Silt (%)	Sand (%)	Gravel (%)	Cobble (%)	Boulder (%)
-	45,7	35,2	19,1	0,0	0,0

D ₁₀ (mm)	D ₃₀ (mm)	D ₆₀ (mm)	C _u	C _c	W _n (%)
N/A	N/A	0,86	N/A	N/A	10

PERCENT PASSING					
(mm)	(%)	(mm)	(%)	(mm)	(%)
80,00	100	2,500	72		
56,00	100	1,250	63		
40,00	100	0,630	58		
31,50	100	0,315	53		
20,00	99	0,160	49		
14,00	97	0,080	45,7		
10,00	92				
5,00	81				

SAMBLE IDENTIFICATION	
Sample	10BH-29 (SS-05)
Depth	3,35 - 3,86 m
Soil Description	
Silt and sand, a little gravel	

Prepared by Benoit St-Pierre **Approved by** Ibrahim Ja'far, ing. **Date** 2010-04-12

CLIENT TransAlta **N/D** G1-09-1532
PROJECT Geotechnical study - Wind energy converters (WEC)
LOCATION St-Valentin (Québec) **NO. LAB.** 36524

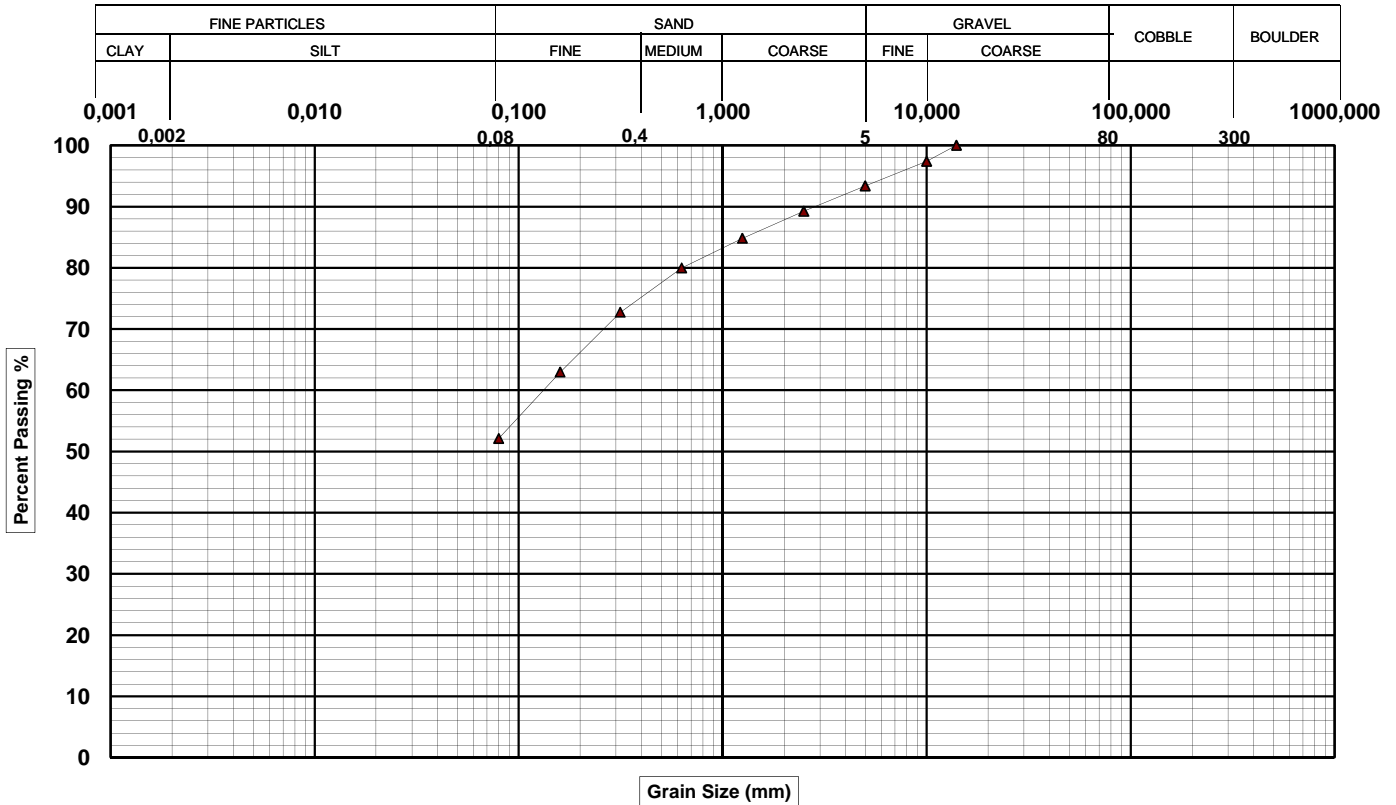

GRAIN-SIZE DISTRIBUTION					
Fine Particles		Coarse Particles			
Clay (%)	Silt (%)	Sand (%)	Gravel (%)	Cobble (%)	Boulder (%)
-	52,1	41,2	6,6	0,0	0,0

D ₁₀ (mm)	D ₃₀ (mm)	D ₆₀ (mm)	C _u	C _c	W _n (%)
N/A	N/A	0,15	N/A	N/A	11

PERCENT PASSING					
(mm)	(%)	(mm)	(%)	(mm)	(%)
80,00	100	2,500	89		
56,00	100	1,250	85		
40,00	100	0,630	80		
31,50	100	0,315	73		
20,00	100	0,160	63		
14,00	100	0,080	52,1		
10,00	97				
5,00	93				

SAMBLE IDENTIFICATION	
Sample	10BH-29 (SS-03)
Depth	1,52 - 2,13 m
Soil Description	
Silt and sand, traces of gravel	

Prepared by Benoit St-Pierre **Approved by** Ibrahim Ja'far, ing. **Date** 2010-04-12

CLIENT	TransAlta	N/D G1-09-1532
PROJECT	Geotechnical study - Wind energy converters (WEC)	
LOCATION	St-Valentin (Québec)	NO. LAB. 36527

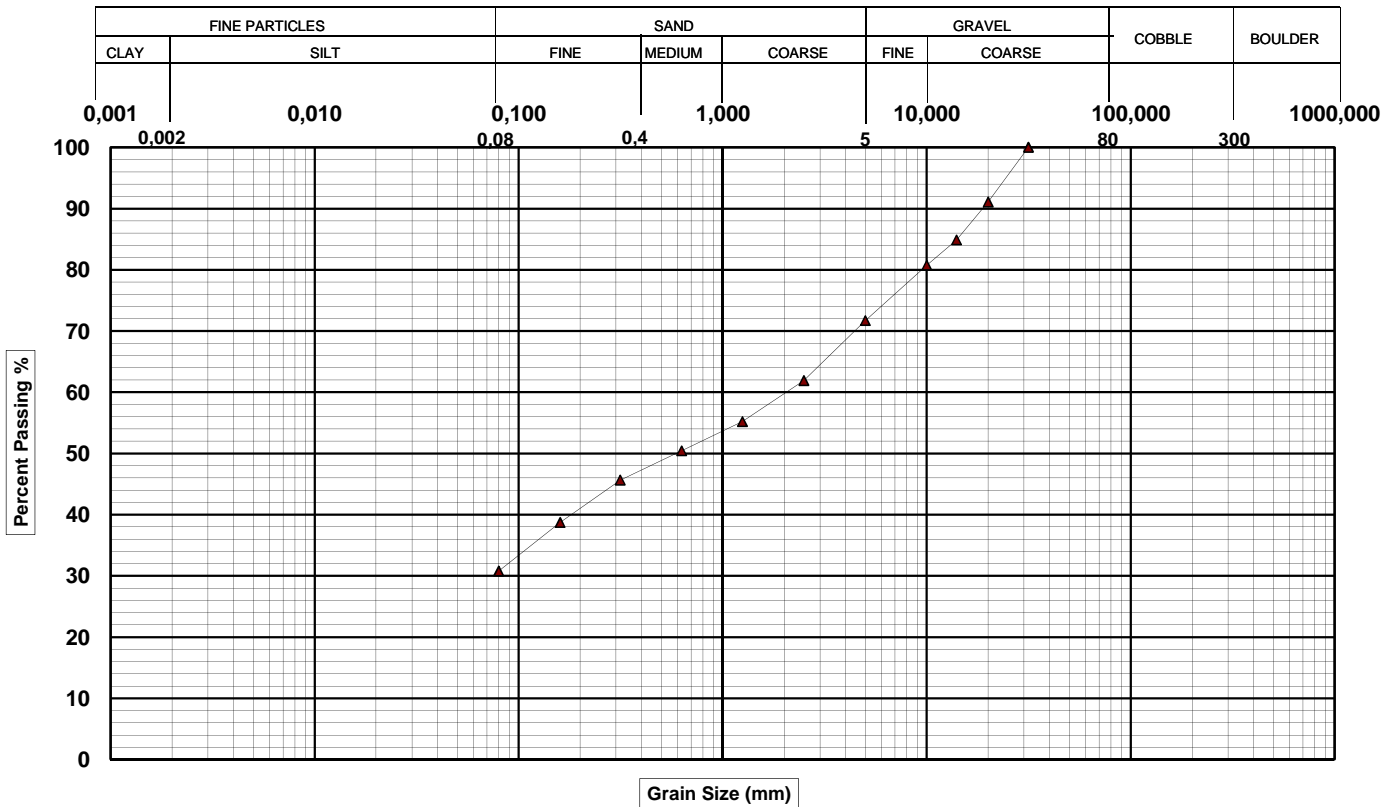

GRAIN-SIZE DISTRIBUTION					
Fine Particles		Coarse Particles			
Clay (%)	Silt (%)	Sand (%)	Gravel (%)	Cobble (%)	Boulder (%)
-	30,8	40,9	28,3	0,0	0,0

D ₁₀ (mm)	D ₃₀ (mm)	D ₆₀ (mm)	C _u	C _c	W _n (%)
N/A	N/A	2,00	N/A	N/A	11

PERCENT PASSING					
(mm)	(%)	(mm)	(%)	(mm)	(%)
80,00	100	2,500	62		
56,00	100	1,250	55		
40,00	100	0,630	50		
31,50	100	0,315	46		
20,00	91	0,160	39		
14,00	85	0,080	30,8		
10,00	81				
5,00	72				

SAMBLE IDENTIFICATION	
Sample	10BH-30 (SS-03)
Depth	1,52 - 2,13 m
Soil Description	
Silty gravelly sand	

Prepared by Benoit St-Pierre **Approved by** Ibrahim Ja'far, ing. **Date** 2010-04-12

CLIENT TransAlta **N/D** G1-09-1532
PROJECT Geotechnical study - Wind energy converters (WEC)
LOCATION St-Valentin (Québec) **NO. LAB.** 36522

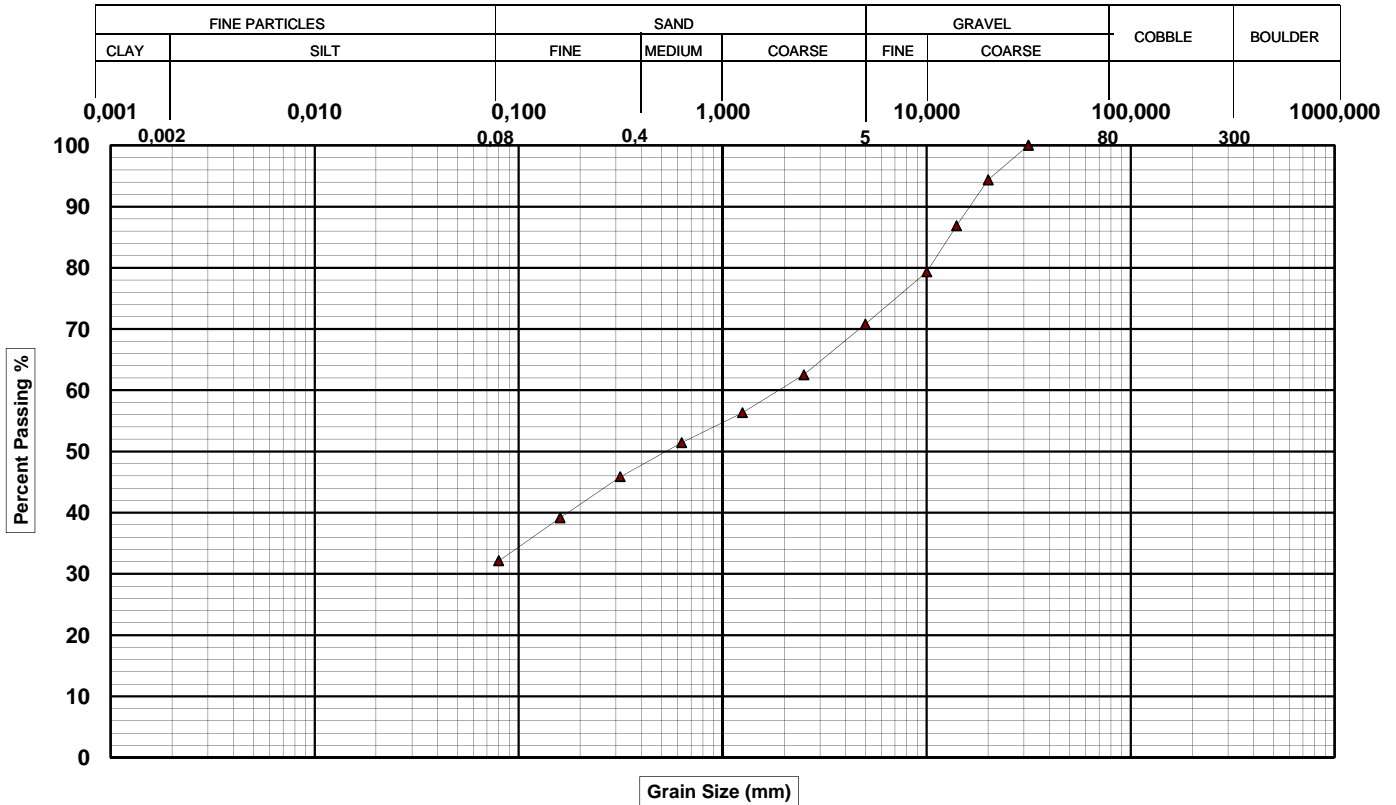

GRAIN-SIZE DISTRIBUTION

Fine Particles		Coarse Particles			
Clay (%)	Silt (%)	Sand (%)	Gravel (%)	Cobble (%)	Boulder (%)
-	32,1	38,7	29,2	0,0	0,0

D ₁₀ (mm)	D ₃₀ (mm)	D ₆₀ (mm)	C _u	C _c	W _n (%)
N/A	N/A	2,00	N/A	N/A	8

PERCENT PASSING

(mm)	(%)	(mm)	(%)	(mm)	(%)
80,00	100	2,500	63		
56,00	100	1,250	56		
40,00	100	0,630	51		
31,50	100	0,315	46		
20,00	94	0,160	39		
14,00	87	0,080	32,1		
10,00	79				
5,00	71				

SAMBLE IDENTIFICATION

Sample	10BH-25 (SS-06)
Depth	4,27 - 4,88 m
Soil Description	
Gravelly silty sand	

Prepared by Benoit St-Pierre

Approved by Ibrahim Ja'far, ing.

Date 2010-04-12

CLIENT TransAlta **N/D** G1-09-1532
PROJECT Geotechnical study - Wind energy converters (WEC)
LOCATION St-Valentin (Québec) **NO. LAB.** 36528

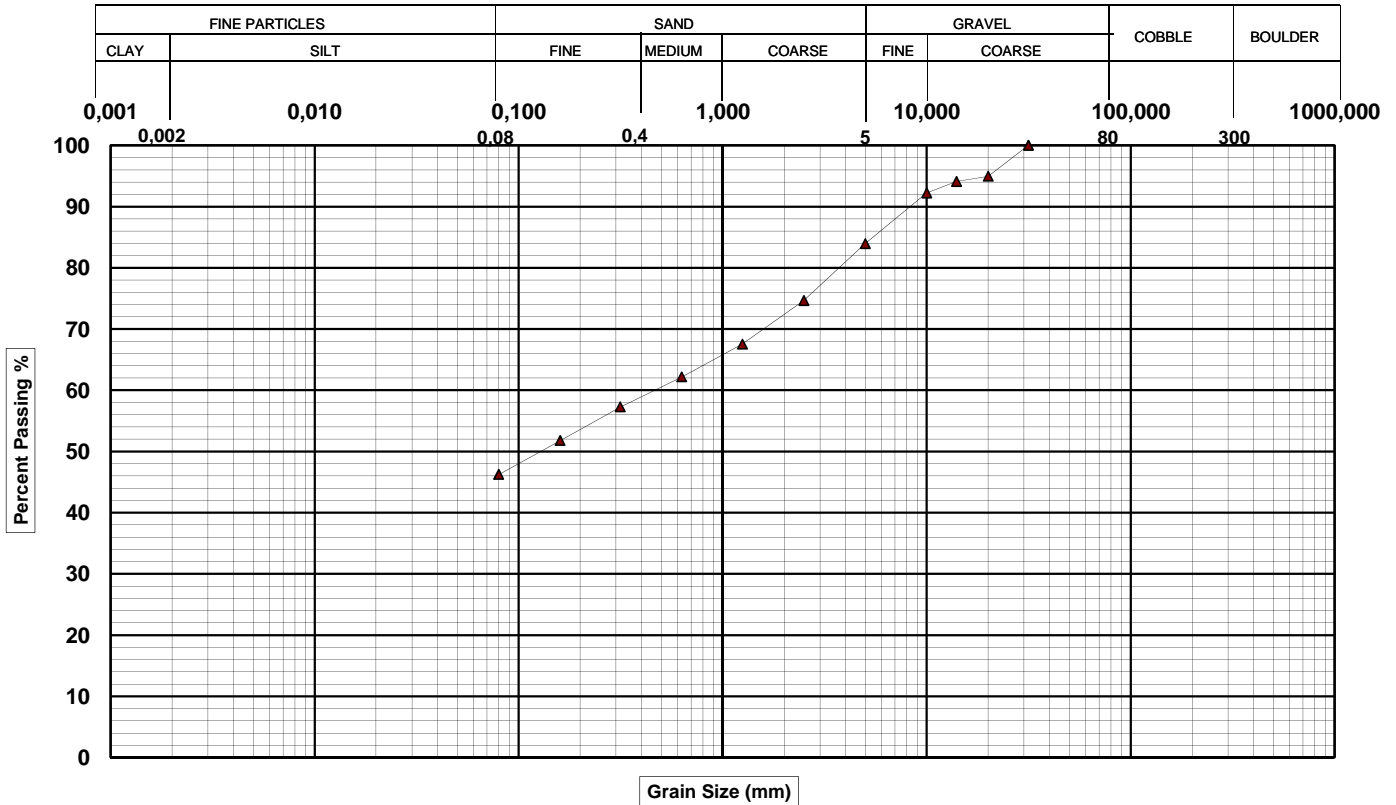

GRAIN-SIZE DISTRIBUTION					
Fine Particles		Coarse Particles			
Clay (%)	Silt (%)	Sand (%)	Gravel (%)	Cobble (%)	Boulder (%)
-	46,2	37,7	16,1	0,0	0,0

D ₁₀ (mm)	D ₃₀ (mm)	D ₆₀ (mm)	C _u	C _c	W _n (%)
N/A	N/A	0,49	N/A	N/A	10

PERCENT PASSING					
(mm)	(%)	(mm)	(%)	(mm)	(%)
80,00	100	2,500	75		
56,00	100	1,250	68		
40,00	100	0,630	62		
31,50	100	0,315	57		
20,00	95	0,160	52		
14,00	94	0,080	46,2		
10,00	92				
5,00	84				

SAMBLE IDENTIFICATION	
Sample	10BH-30 (SS-06)
Depth	4,57 - 5,18 m
Soil Description	
Silt and sand, some gravel	

Prepared by Benoit St-Pierre **Approved by** Ibrahim Ja'far, ing. **Date** 2010-04-12

CLIENT	TransAlta	N/D G1-09-1532
PROJECT	Geotechnical study - Wind energy converters (WEC)	
LOCATION	St-Valentin (Québec)	NO. LAB. 36521

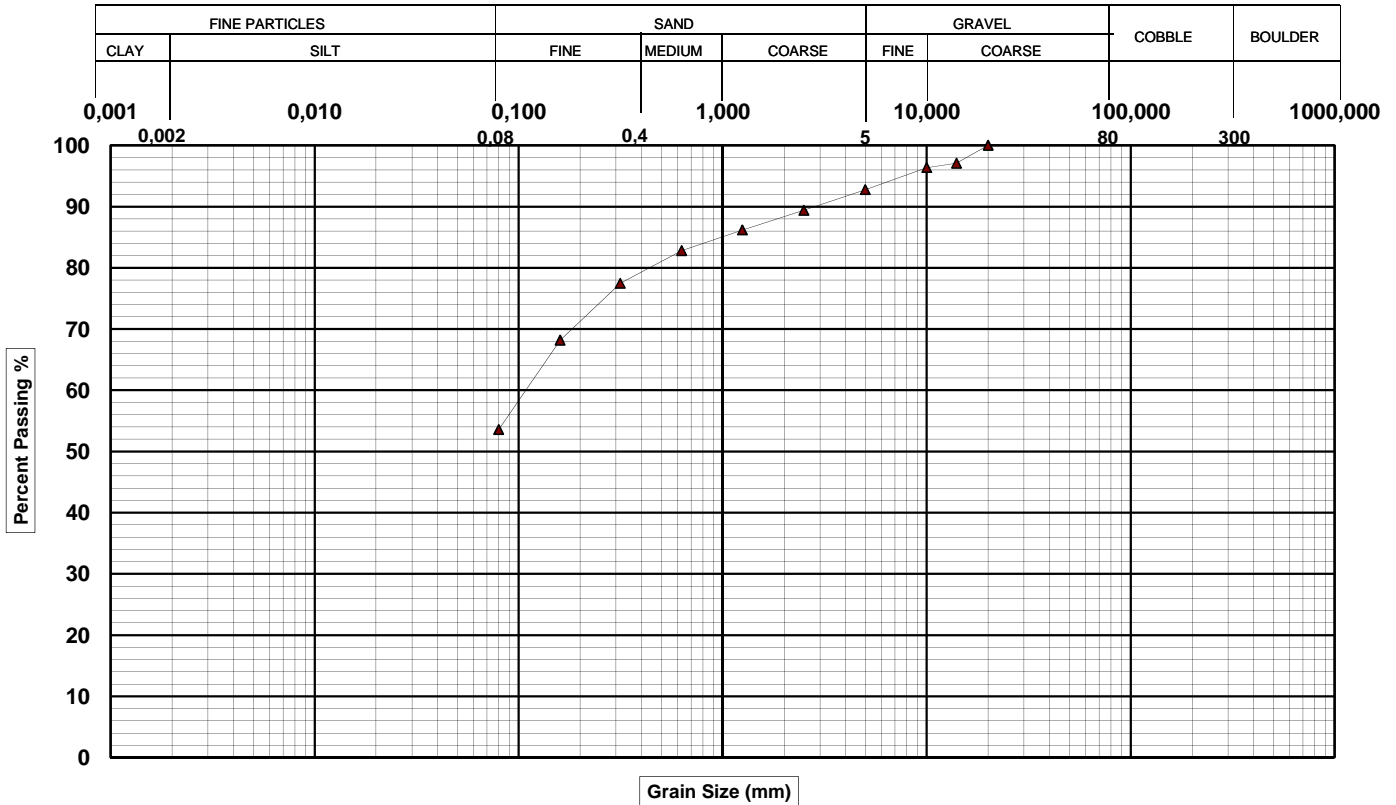

GRAIN-SIZE DISTRIBUTION					
Fine Particles		Coarse Particles			
Clay (%)	Silt (%)	Sand (%)	Gravel (%)	Cobble (%)	Boulder (%)
-	53,6	39,2	7,2	0,0	0,0

D₁₀ (mm)	D₃₀ (mm)	D₆₀ (mm)	C_u	C_c	W_n (%)
N/A	N/A	0,11	N/A	N/A	11

PERCENT PASSING					
(mm)	(%)	(mm)	(%)	(mm)	(%)
80,00	100	2,500	89		
56,00	100	1,250	86		
40,00	100	0,630	83		
31,50	100	0,315	77		
20,00	100	0,160	68		
14,00	97	0,080	53,6		
10,00	96				
5,00	93				

SAMBLE IDENTIFICATION	
Sample	10BH-26 (SS-03)
Depth	1,52 - 2,13 m
Soil Description	
Silt and sand, taces of gravel	

Prepared by Benoit St-Pierre **Approved by** Ibrahim Ja'far, ing. **Date** 2010-04-12

CLIENT TransAlta **N/D** G1-09-1532
PROJECT Geotechnical study - Wind energy converters (WEC)
LOCATION St-Valentin (Québec) **NO. LAB.** 36529

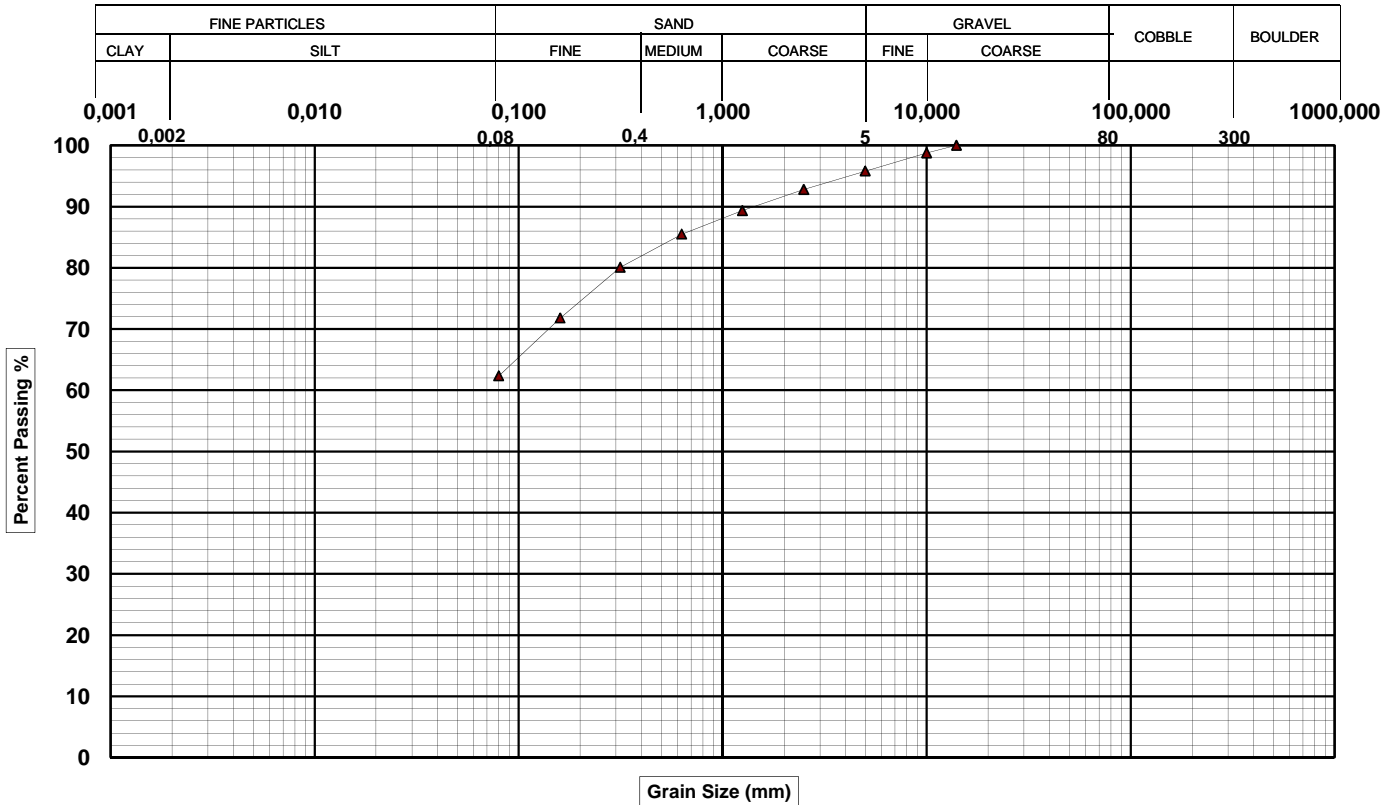

GRAIN-SIZE DISTRIBUTION					
Fine Particles		Coarse Particles			
Clay (%)	Silt (%)	Sand (%)	Gravel (%)	Cobble (%)	Boulder (%)
-	62,3	33,4	4,2	0,0	0,0

D ₁₀ (mm)	D ₃₀ (mm)	D ₆₀ (mm)	C _u	C _c	W _n (%)
N/A	N/A	N/A	N/A	N/A	6

PERCENT PASSING					
(mm)	(%)	(mm)	(%)	(mm)	(%)
80,00	100	2,500	93		
56,00	100	1,250	89		
40,00	100	0,630	86		
31,50	100	0,315	80		
20,00	100	0,160	72		
14,00	100	0,080	62,3		
10,00	99				
5,00	96				

SAMBLE IDENTIFICATION	
Sample	10BH-32 (SS-02)
Depth	0,61 - 1,22
Soil Description	
Silt and sand, traces of gravel	

Prepared by Benoit St-Pierre **Approved by** Ibrahim Ja'far, ing. **Date** 2010-04-12

CLIENT TransAlta **N/D** G1-09-1532
PROJECT Geotechnical study - Wind energy converters (WEC)
LOCATION St-Valentin (Québec) **NO. LAB.** 36530

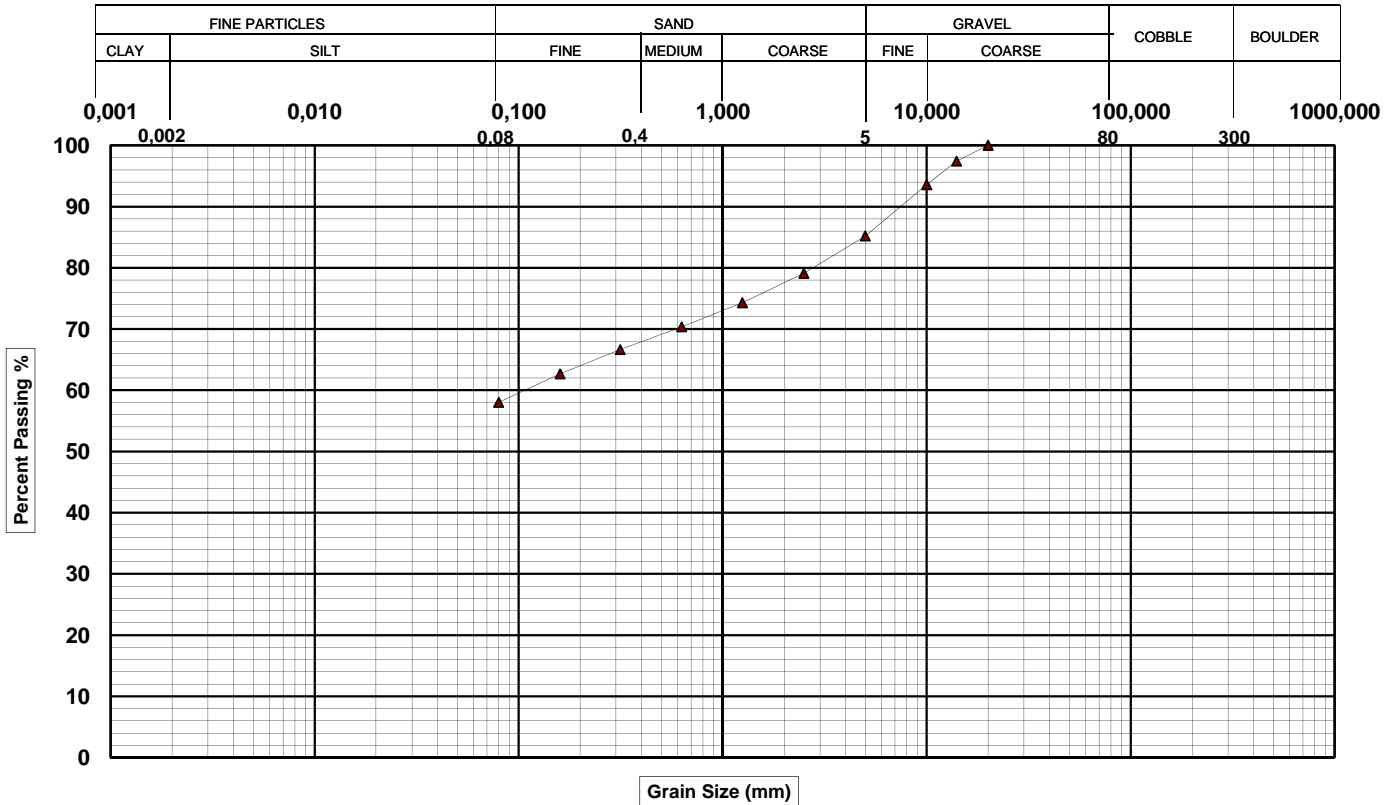

GRAIN-SIZE DISTRIBUTION					
Fine Particles			Coarse Particles		
Clay (%)	Silt (%)	Sand (%)	Gravel (%)	Cobble (%)	Boulder (%)
-	58,1	27,1	14,8	0,0	0,0

D₁₀ (mm)	D₃₀ (mm)	D₆₀ (mm)	C_u	C_c	W_n (%)
N/A	N/A	0,11	N/A	N/A	12

PERCENT PASSING					
(mm)	(%)	(mm)	(%)	(mm)	(%)
80,00	100	2,500	79		
56,00	100	1,250	74		
40,00	100	0,630	70		
31,50	100	0,315	67		
20,00	100	0,160	63		
14,00	97	0,080	58,1		
10,00	94				
5,00	85				

SAMBLE IDENTIFICATION	
Sample	10BH-32 (SS-07)
Depth	4,57 - 5,18 m
Soil Description	
Sandy silt, some gravel	

Prepared by Benoit St-Pierre **Approved by** Ibrahim Ja'far, ing. **Date** 2010-04-12

CLIENT TransAlta **N/D** G1-09-1532
PROJECT Geotechnical study - Wind energy converters (WEC)
LOCATION St-Valentin **NO. LAB.** 36545

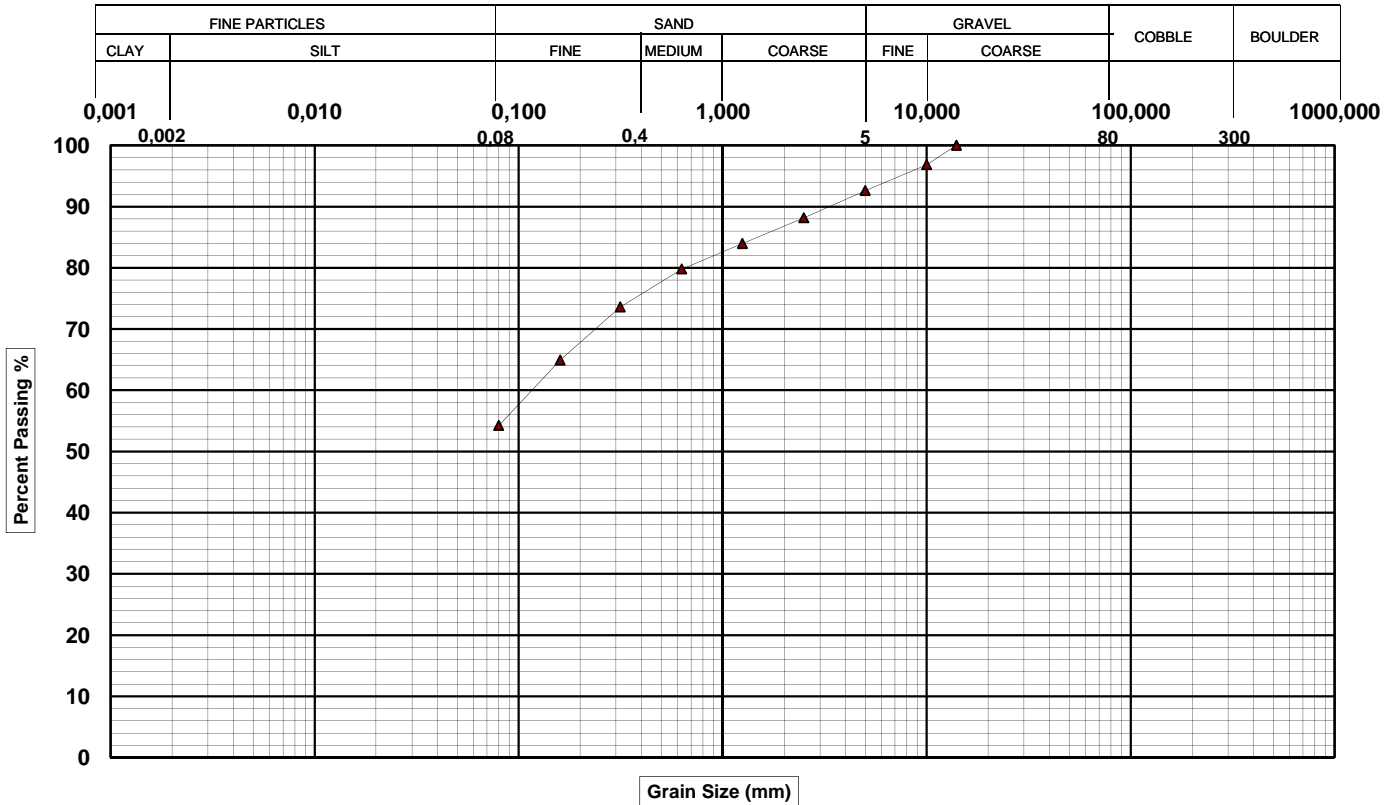

GRAIN-SIZE DISTRIBUTION					
Fine Particles			Coarse Particles		
Clay (%)	Silt (%)	Sand (%)	Gravel (%)	Cobble (%)	Boulder (%)
-	54,2	38,4	7,4	0,0	0,0

D₁₀ (mm)	D₃₀ (mm)	D₆₀ (mm)	C_u	C_c	W_n (%)
N/A	N/A	0,12	N/A	N/A	10

PERCENT PASSING					
(mm)	(%)	(mm)	(%)	(mm)	(%)
80,00	100	2,500	88		
56,00	100	1,250	84		
40,00	100	0,630	80		
31,50	100	0,315	74		
20,00	100	0,160	65		
14,00	100	0,080	54,2		
10,00	97				
5,00	93				

SAMBLE IDENTIFICATION	
Sample	10BH-17A (SS-07)
Depth	5,18 - 5,79 m
Soil Description	
Silt and sand, traces of gravel	

Prepared by Benoit St-Pierre **Approved by** Ibrahim Ja'far, ing. **Date** 2010-04-14

CLIENT	TransAlta	N/D G1-09-1532
PROJECT	Geotechnical study - Wind energy converters (WEC)	
LOCATION	St-Valentin	NO. LAB. 36535

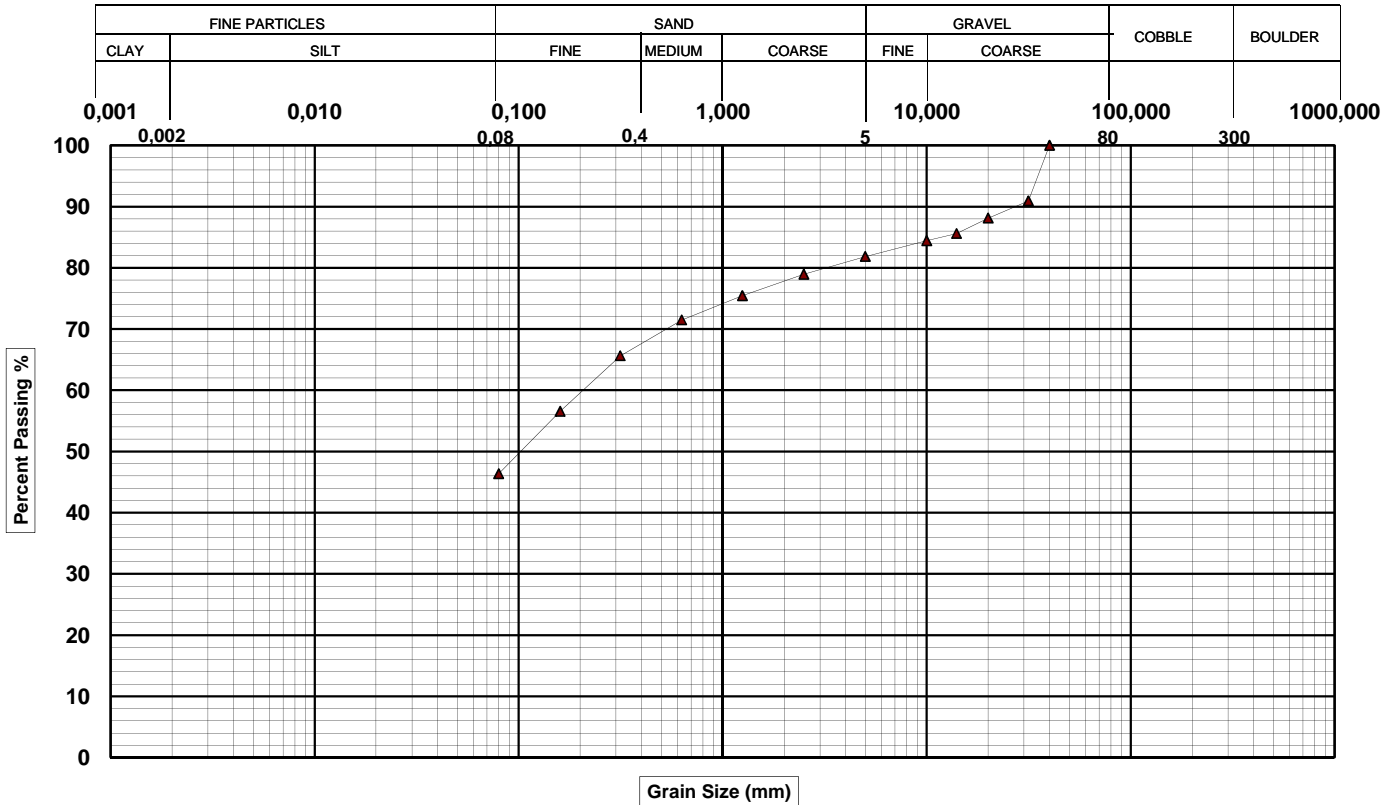

GRAIN-SIZE DISTRIBUTION					
Fine Particles		Coarse Particles			
Clay (%)	Silt (%)	Sand (%)	Gravel (%)	Cobble (%)	Boulder (%)
-	46,4	35,5	18,2	0,0	0,0

D₁₀ (mm)	D₃₀ (mm)	D₆₀ (mm)	C_u	C_c	W_n (%)
N/A	N/A	0,20	N/A	N/A	9

PERCENT PASSING					
(mm)	(%)	(mm)	(%)	(mm)	(%)
80,00	100	2,500	79		
56,00	100	1,250	75		
40,00	100	0,630	71		
31,50	91	0,315	66		
20,00	88	0,160	57		
14,00	86	0,080	46,4		
10,00	84				
5,00	82				

SAMBLE IDENTIFICATION	
Sample	10BH-10 (SS-04)
Depth	2,44 - 3,05 m
Soil Description	
Silt and sand, some gravel	

Prepared by Benoit St-Pierre	Approved by Ibrahim Ja'far, ing.	Date 2010-04-14
-------------------------------------	---	------------------------

CLIENT TransAlta **N/D** G1-09-1532
PROJECT Geotechnical study - Wind energy converters (WEC)
LOCATION St-Valentin **NO. LAB.** 36536

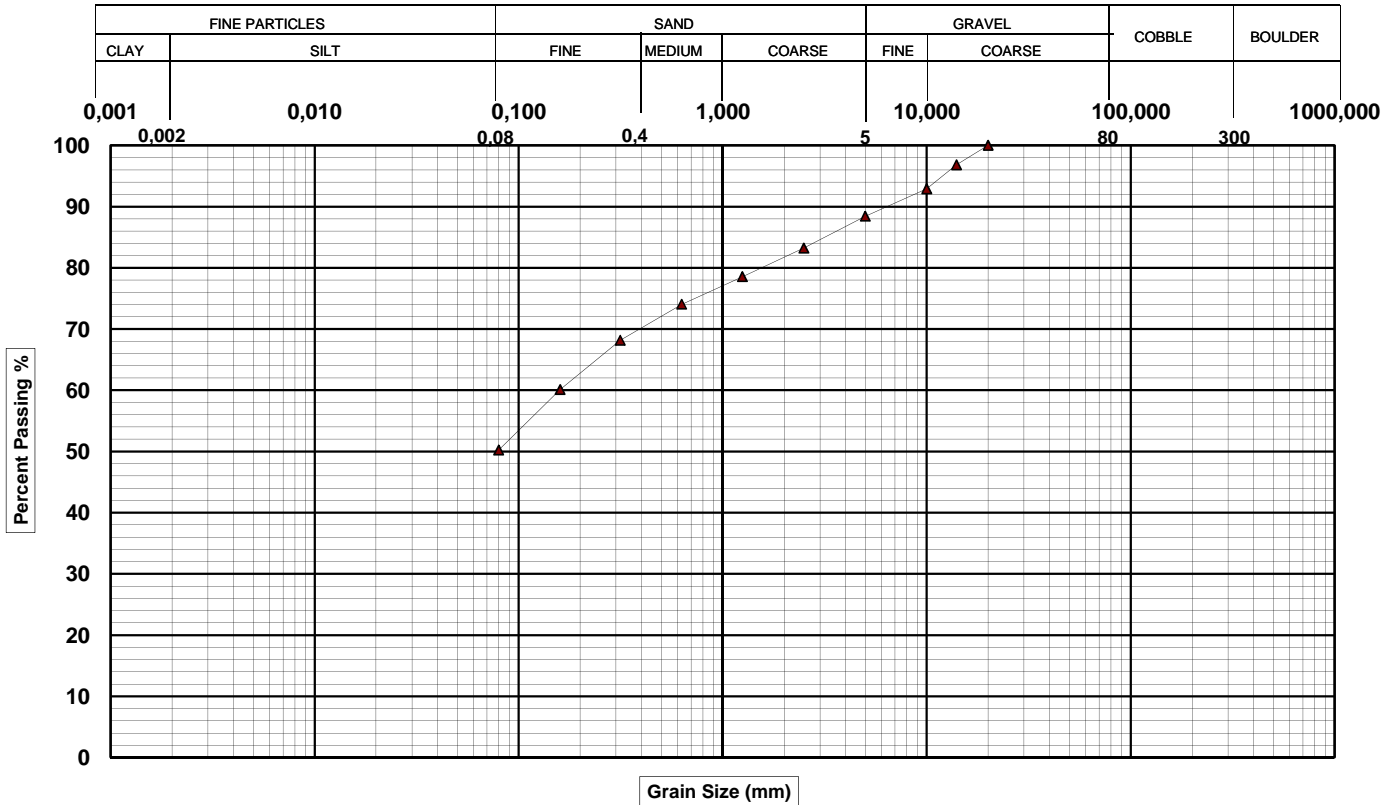

GRAIN-SIZE DISTRIBUTION					
Fine Particles		Coarse Particles			
Clay (%)	Silt (%)	Sand (%)	Gravel (%)	Cobble (%)	Boulder (%)
-	50,2	38,2	11,6	0,0	0,0

D ₁₀ (mm)	D ₃₀ (mm)	D ₆₀ (mm)	C _u	C _c	W _n (%)
N/A	N/A	0,17	N/A	N/A	8

PERCENT PASSING					
(mm)	(%)	(mm)	(%)	(mm)	(%)
80,00	100	2,500	83		
56,00	100	1,250	79		
40,00	100	0,630	74		
31,50	100	0,315	68		
20,00	100	0,160	60		
14,00	97	0,080	50,2		
10,00	93				
5,00	88				

SAMBLE IDENTIFICATION	
Sample	10BH-10 (SS-08)
Depth	6,10 - 6,71 m
Soil Description	
Silt and sand, some gravel	

Prepared by Benoit St-Pierre **Approved by** Ibrahim Ja'far, ing. **Date** 2010-04-14

CLIENT TransAlta **N/D** G1-09-1532
PROJECT Geotechnical study - Wind energy converters (WEC)
LOCATION St-Valentin **NO. LAB.** 36539

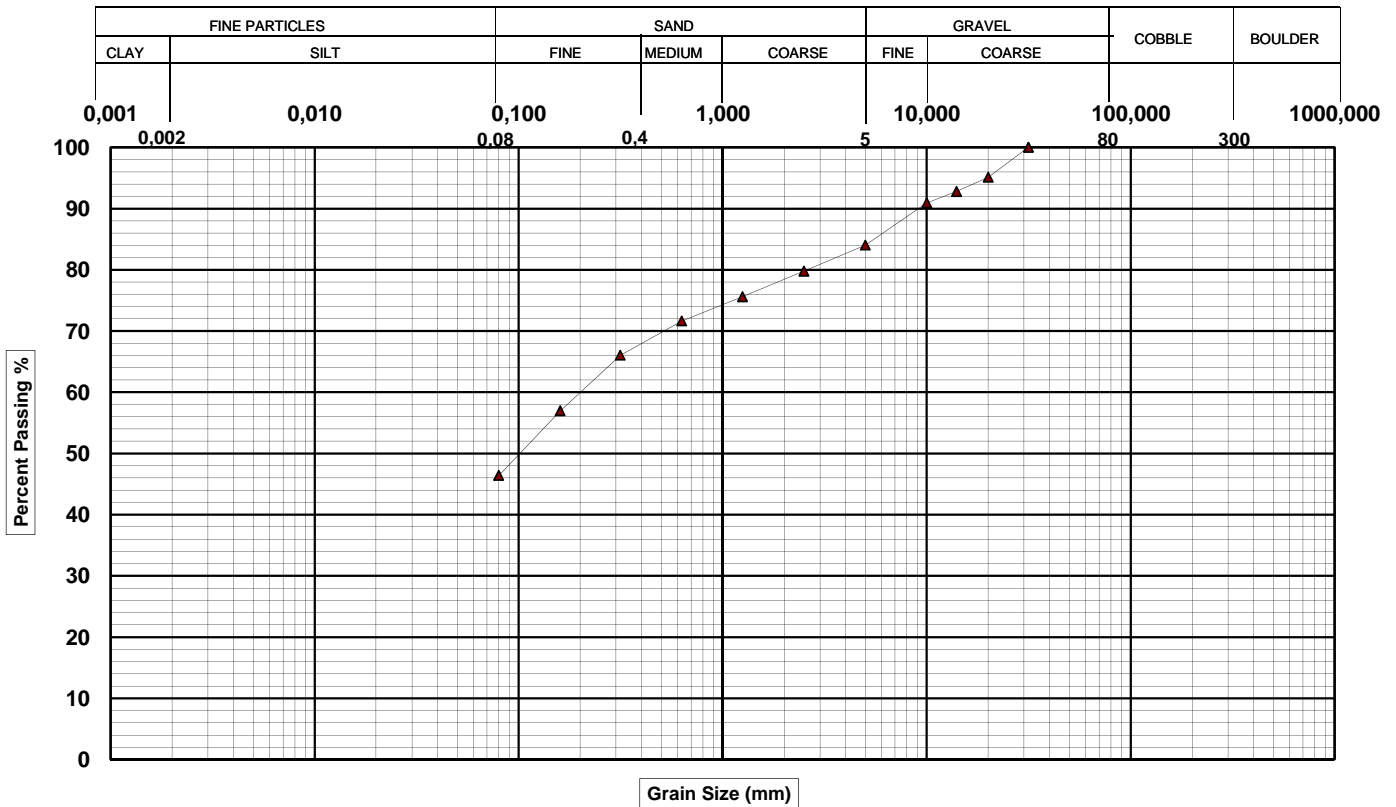

GRAIN-SIZE DISTRIBUTION					
Fine Particles		Coarse Particles			
Clay (%)	Silt (%)	Sand (%)	Gravel (%)	Cobble (%)	Boulder (%)
-	46,4	37,6	16,0	0,0	0,0

D ₁₀ (mm)	D ₃₀ (mm)	D ₆₀ (mm)	C _u	C _c	W _n (%)
N/A	N/A	0,20	N/A	N/A	9

PERCENT PASSING					
(mm)	(%)	(mm)	(%)	(mm)	(%)
80,00	100	2,500	80		
56,00	100	1,250	76		
40,00	100	0,630	72		
31,50	100	0,315	66		
20,00	95	0,160	57		
14,00	93	0,080	46,4		
10,00	91				
5,00	84				

SAMBLE IDENTIFICATION	
Sample	10BH-16 (SS-08)
Depth	6,10 - 6,71 m
Soil Description	
Silt and sand, a little gravel	

Prepared by Benoit St-Pierre **Approved by** Ibrahim Ja'far, ing. **Date** 2010-04-14

CLIENT TransAlta **N/D** G1-09-1532
PROJECT Geotechnical study - Wind energy converters (WEC)
LOCATION St-Valentin **NO. LAB.** 36534

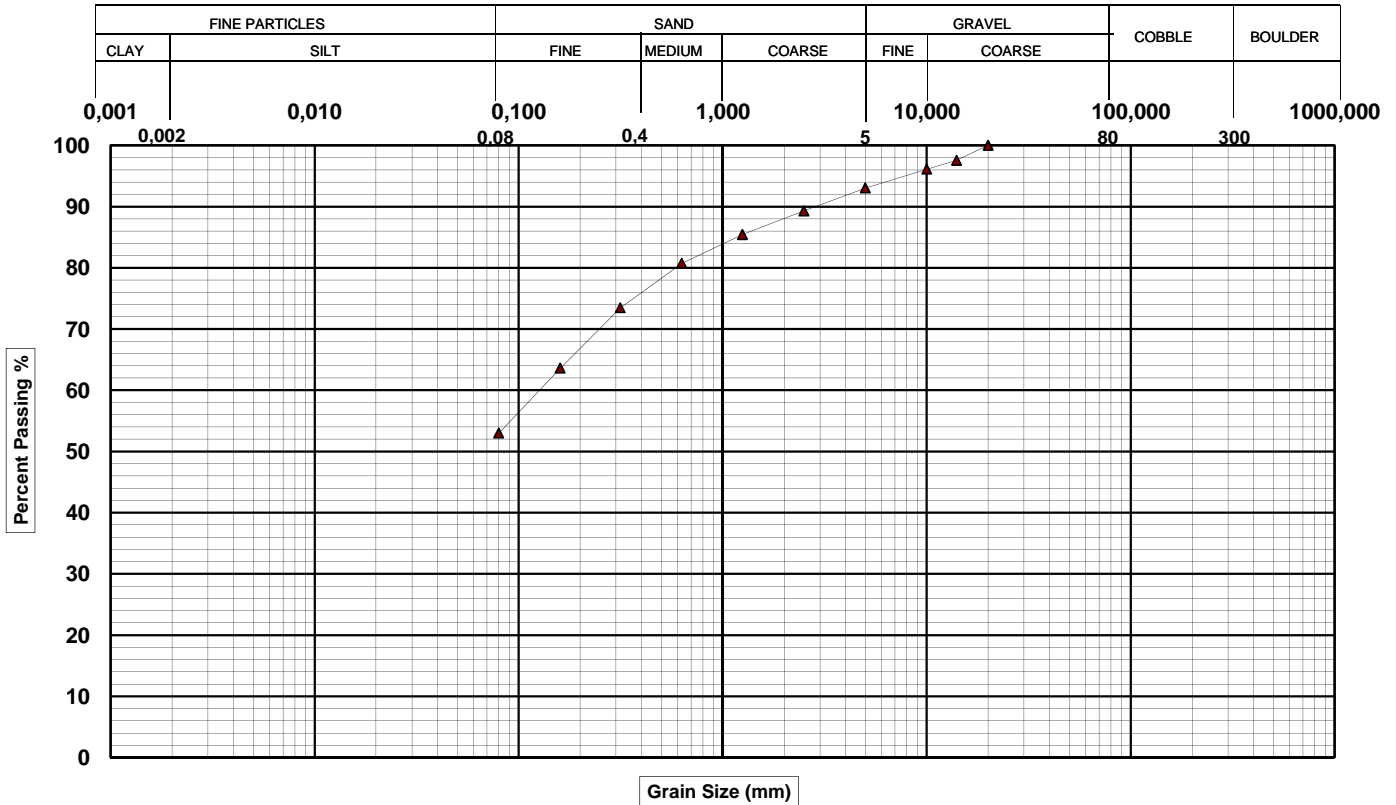

GRAIN-SIZE DISTRIBUTION

Fine Particles		Coarse Particles			
Clay (%)	Silt (%)	Sand (%)	Gravel (%)	Cobble (%)	Boulder (%)
-	53,0	40,0	7,0	0,0	0,0

D ₁₀ (mm)	D ₃₀ (mm)	D ₆₀ (mm)	C _u	C _c	W _n (%)
N/A	N/A	0,13	N/A	N/A	10

PERCENT PASSING

(mm)	(%)	(mm)	(%)	(mm)	(%)
80,00	100	2,500	89		
56,00	100	1,250	85		
40,00	100	0,630	81		
31,50	100	0,315	73		
20,00	100	0,160	64		
14,00	98	0,080	53,0		
10,00	96				
5,00	93				

SAMBLE IDENTIFICATION

Sample	10BH-10 (SS-02)
Depth	0,61 - 1,22 m
Soil Description	
Silt and sand, traces of gravel	

Prepared by Benoit St-Pierre **Approved by** Ibrahim Ja'far, ing. **Date** 2010-04-14

CLIENT	TransAlta	N/D G1-09-1532
PROJECT	Geotechnical study - Wind energy converters (WEC)	
LOCATION	St-Valentin	NO. LAB. 36537

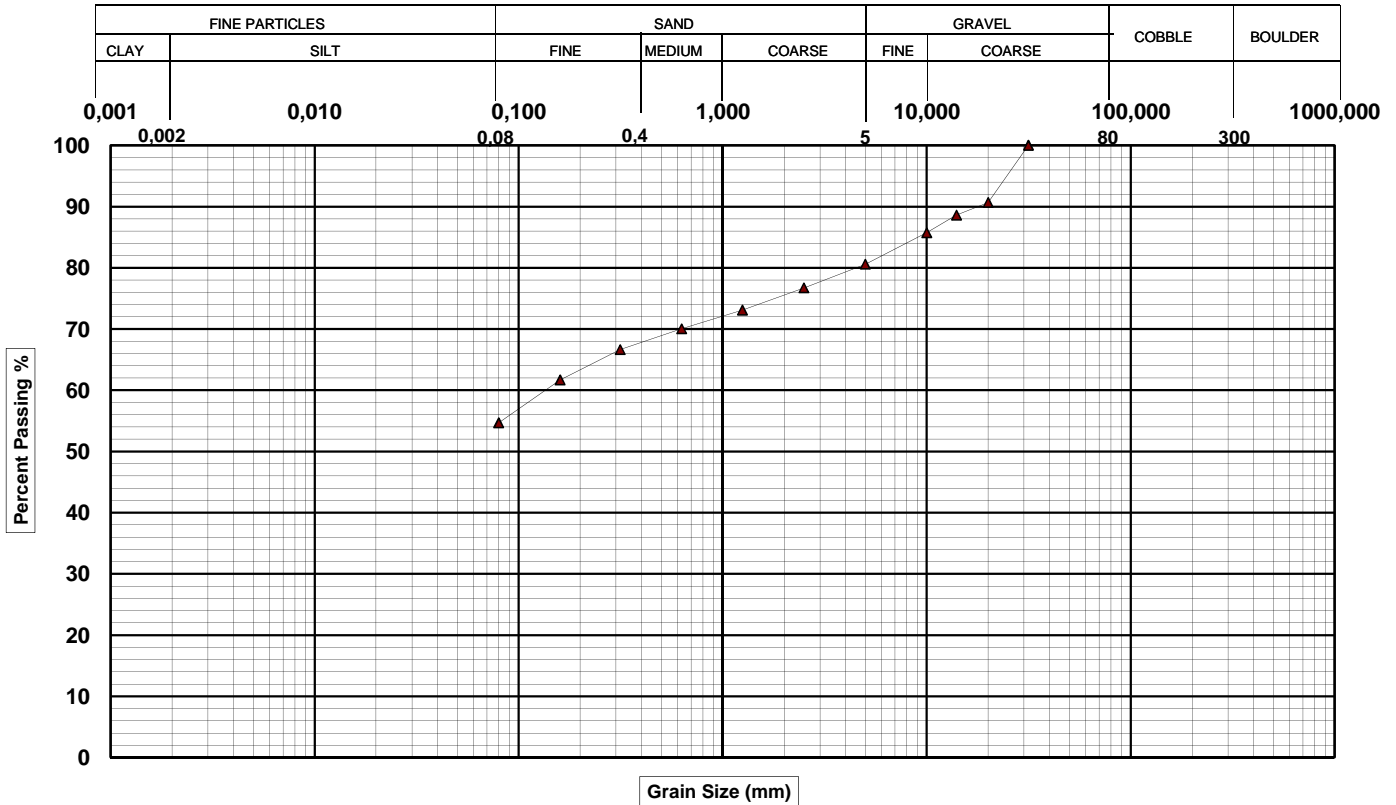

GRAIN-SIZE DISTRIBUTION					
Fine Particles			Coarse Particles		
Clay (%)	Silt (%)	Sand (%)	Gravel (%)	Cobble (%)	Boulder (%)
-	54,7	25,9	19,4	0,0	0,0

D₁₀ (mm)	D₃₀ (mm)	D₆₀ (mm)	C_u	C_c	W_n (%)
N/A	N/A	0,15	N/A	N/A	11

PERCENT PASSING					
(mm)	(%)	(mm)	(%)	(mm)	(%)
80,00	100	2,500	77		
56,00	100	1,250	73		
40,00	100	0,630	70		
31,50	100	0,315	67		
20,00	91	0,160	62		
14,00	89	0,080	54,7		
10,00	86				
5,00	81				

SAMBLE IDENTIFICATION	
Sample	10BH-10 (SS-16)
Depth	16,5 - 16,927 m
Soil Description	
Sandy silt, some gravel	

Prepared by Benoit St-Pierre Approved by Ibrahim Ja'far, ing. Date 2010-04-14

CLIENT TransAlta **N/D** G1-09-1532
PROJECT Geotechnical study - Wind energy converters (WEC)
LOCATION St-Valentin **NO. LAB.** 36542

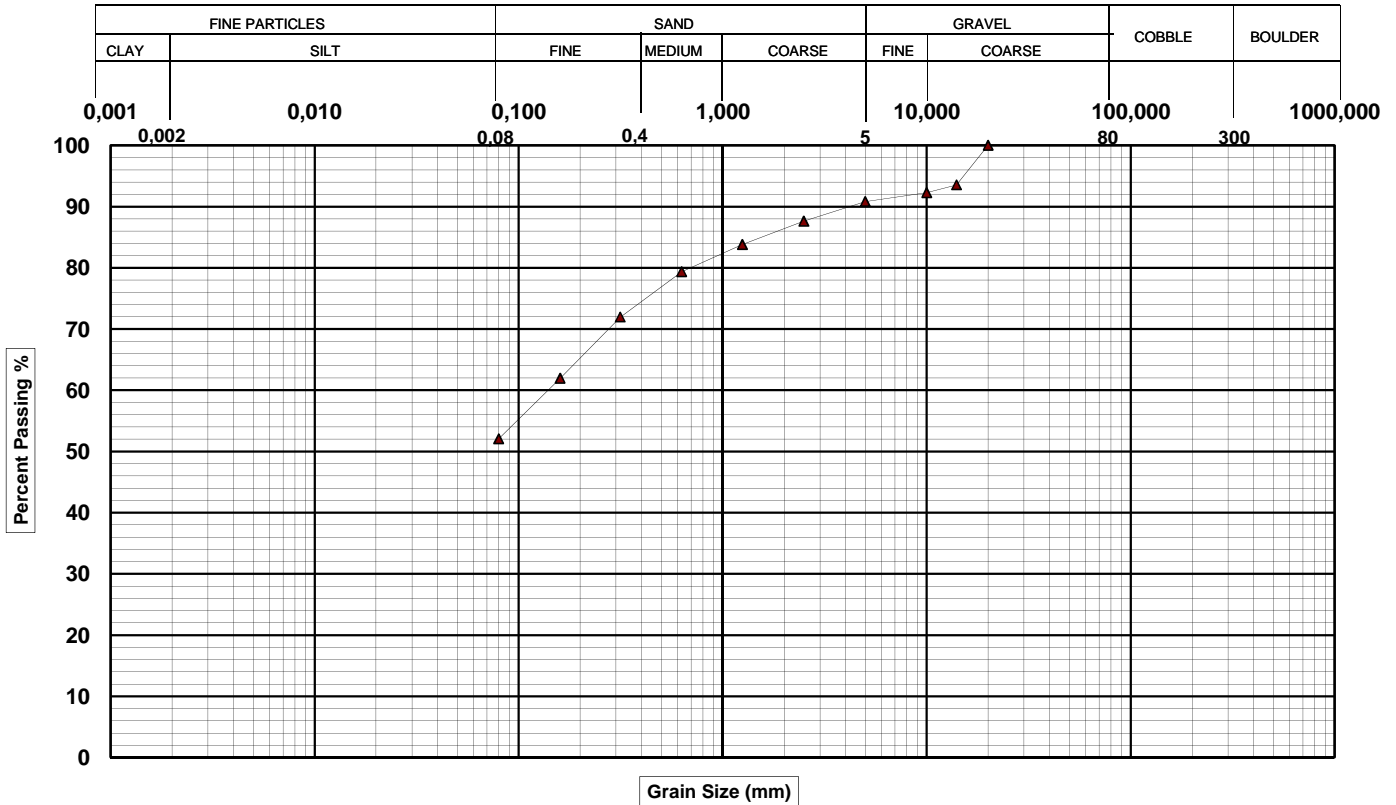

GRAIN-SIZE DISTRIBUTION					
Fine Particles		Coarse Particles			
Clay (%)	Silt (%)	Sand (%)	Gravel (%)	Cobble (%)	Boulder (%)
-	52,1	38,8	9,2	0,0	0,0

D ₁₀ (mm)	D ₃₀ (mm)	D ₆₀ (mm)	C _u	C _c	W _n (%)
N/A	N/A	0,15	N/A	N/A	11

PERCENT PASSING					
(mm)	(%)	(mm)	(%)	(mm)	(%)
80,00	100	2,500	88		
56,00	100	1,250	84		
40,00	100	0,630	79		
31,50	100	0,315	72		
20,00	100	0,160	62		
14,00	94	0,080	52,1		
10,00	92				
5,00	91				

SAMBLE IDENTIFICATION	
Sample	10BH-09 (SS-03)
Depth	1,22 - 1,83 m
Soil Description	
Silt and sand, traces of gravel	

Prepared by Benoit St-Pierre **Approved by** Ibrahim Ja'far, ing. **Date** 2010-04-14

CLIENT TransAlta **N/D** G1-09-1532
PROJECT Geotechnical study - Wind energy converters (WEC)
LOCATION St-Valentin **NO. LAB.** 36543

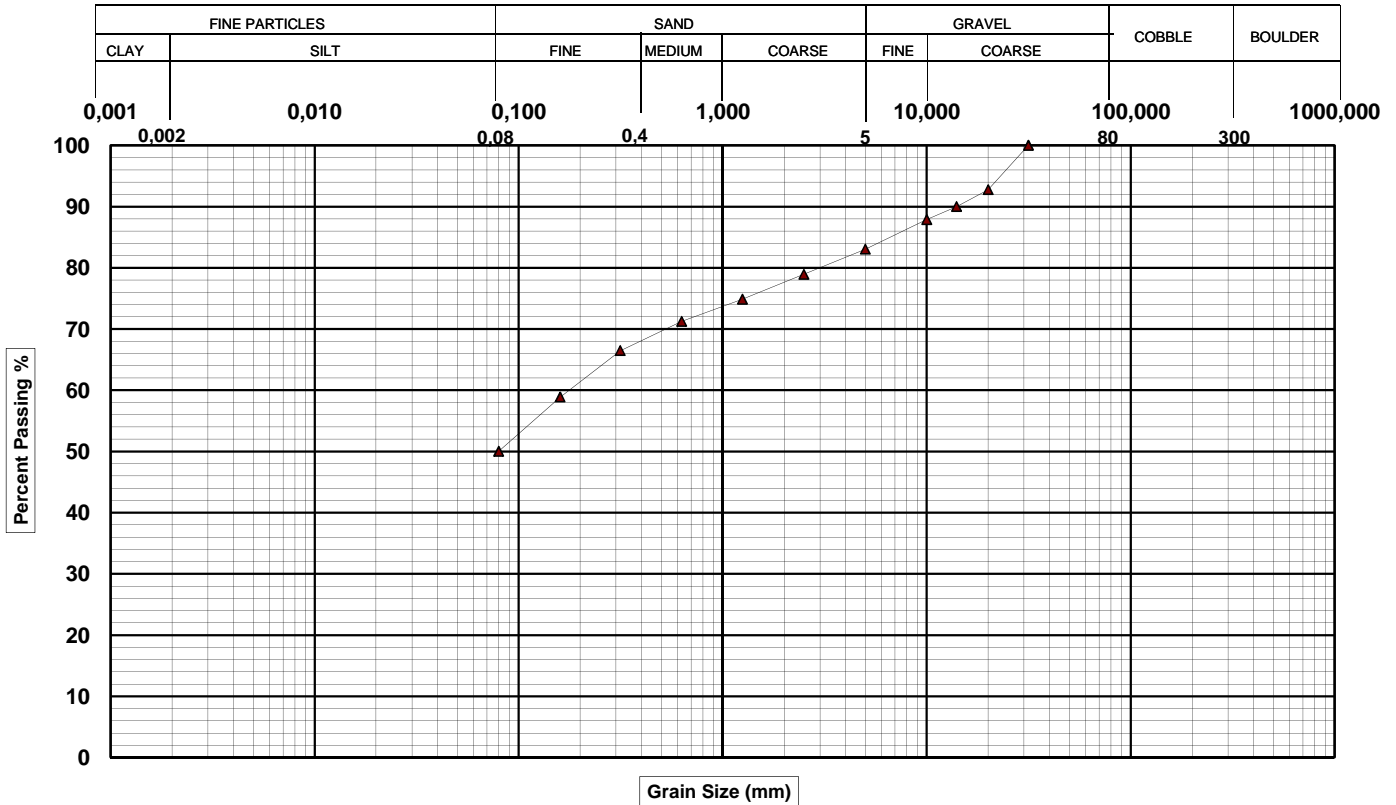

GRAIN-SIZE DISTRIBUTION					
Fine Particles		Coarse Particles			
Clay (%)	Silt (%)	Sand (%)	Gravel (%)	Cobble (%)	Boulder (%)
-	50,0	33,0	17,0	0,0	0,0

D ₁₀ (mm)	D ₃₀ (mm)	D ₆₀ (mm)	C _u	C _c	W _n (%)
N/A	N/A	0,19	N/A	N/A	10

PERCENT PASSING					
(mm)	(%)	(mm)	(%)	(mm)	(%)
80,00	100	2,500	79		
56,00	100	1,250	75		
40,00	100	0,630	71		
31,50	100	0,315	66		
20,00	93	0,160	59		
14,00	90	0,080	50,0		
10,00	88				
5,00	83				

SAMBLE IDENTIFICATION	
Sample	10BH-09 (SS-07)
Depth	4,57 - 5,18 m
Soil Description	
Sandy silt, some gravel	

Prepared by Benoit St-Pierre **Approved by** Ibrahim Ja'far, ing. **Date** 2010-04-14

CLIENT	TransAlta	N/D G1-09-1532
PROJECT	Geotechnical study - Wind energy converters (WEC)	
LOCATION	St-Valentin	NO. LAB. 36547

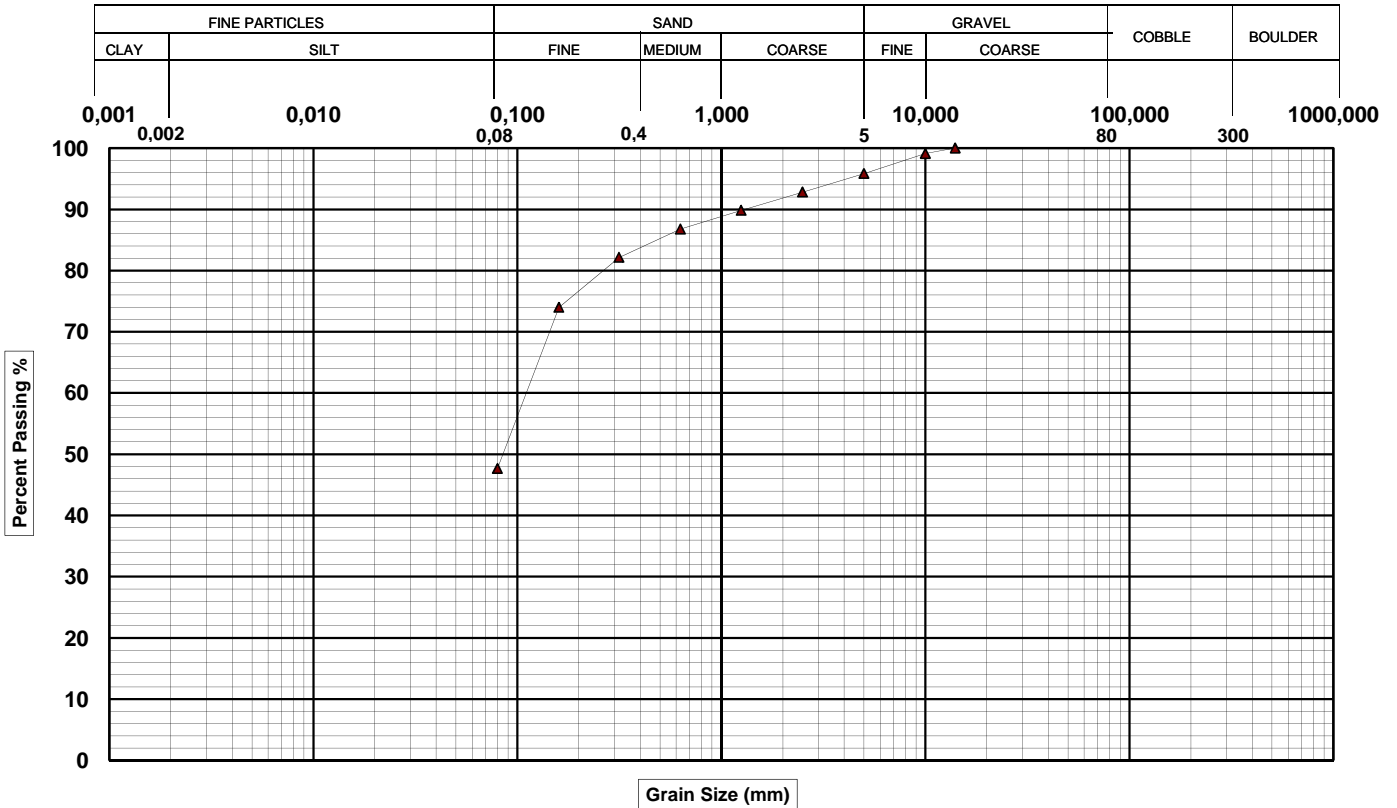

-	47,7	48,2	4,2	0,0	0,0
---	------	------	-----	-----	-----

D₁₀ (mm)	D₃₀ (mm)	D₆₀ (mm)	C_u	C_c	W_n (%)
N/A	N/A	0,11	N/A	N/A	9

PERCENT PASSING					
(mm)	(%)	(mm)	(%)	(mm)	(%)
80,00	100	2,500	93		
56,00	100	1,250	90		
40,00	100	0,630	87		
31,50	100	0,315	82		
20,00	100	0,160	74		
14,00	100	0,080	47,7		
10,00	99				
5,00	96				

SAMBLE IDENTIFICATION	
Sample	10BH-17A (SS-10)
Depth	7,92 - 8,53 m
Soil Description	
Sand and silt, traces of gravel	

Prepared by Benoit St-Pierre Approved by Ibrahim Ja'far, ing. Date 2010-04-14

CLIENT TransAlta **N/D** G1-09-1532
PROJECT Geotechnical study - Wind energy converters (WEC)
LOCATION St-Valentin **NO. LAB.** 36546

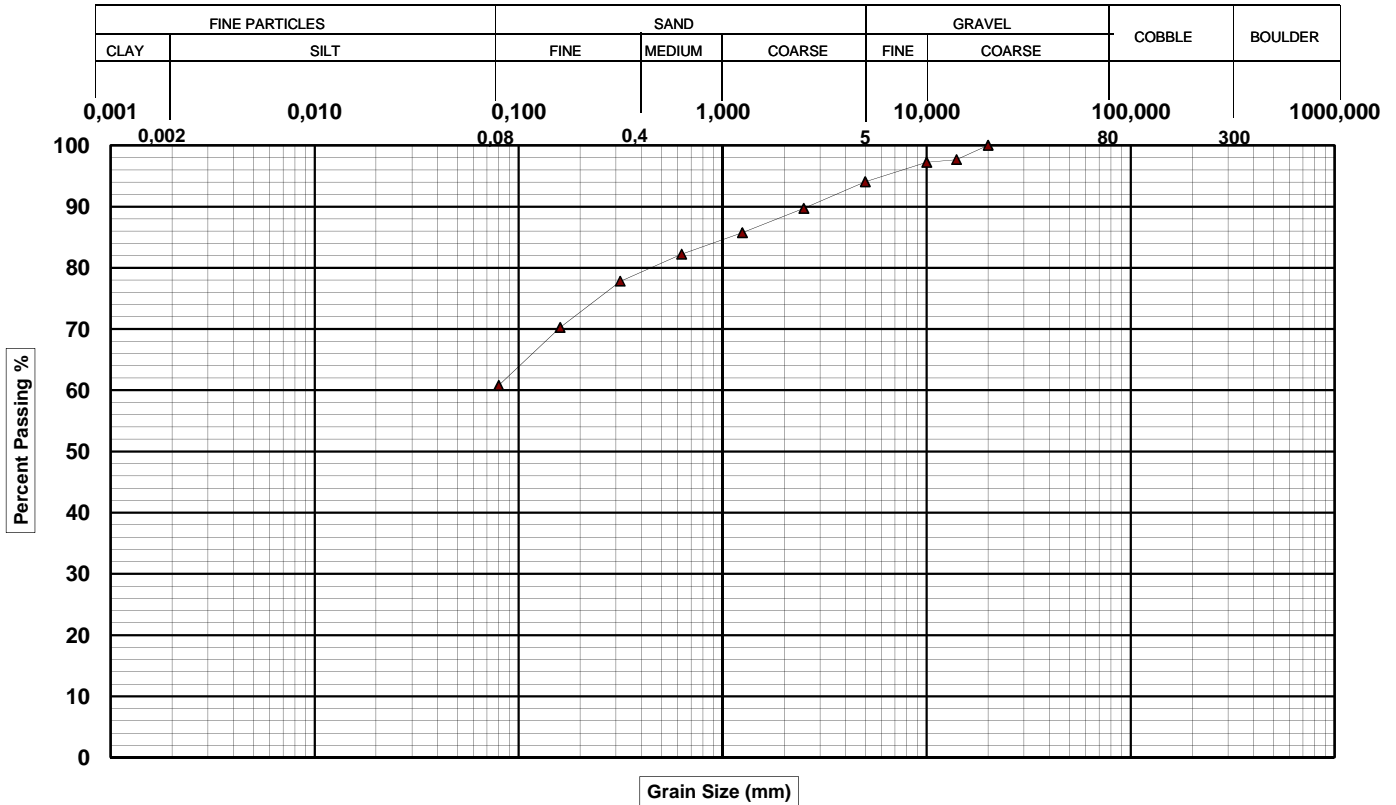

GRAIN-SIZE DISTRIBUTION					
Fine Particles		Coarse Particles			
Clay (%)	Silt (%)	Sand (%)	Gravel (%)	Cobble (%)	Boulder (%)
-	60,8	33,2	6,0	0,0	0,0

D ₁₀ (mm)	D ₃₀ (mm)	D ₆₀ (mm)	C _u	C _c	W _n (%)
N/A	N/A	N/A	N/A	N/A	9

PERCENT PASSING					
(mm)	(%)	(mm)	(%)	(mm)	(%)
80,00	100	2,500	90		
56,00	100	1,250	86		
40,00	100	0,630	82		
31,50	100	0,315	78		
20,00	100	0,160	70		
14,00	98	0,080	60,8		
10,00	97				
5,00	94				

SAMBLE IDENTIFICATION	
Sample	10BH-17A (SS-12)
Depth	9,75 - 10,36 m
Soil Description	
Sandy silt, traces of gravel	

Prepared by Benoit St-Pierre **Approved by** Ibrahim Ja'far, ing. **Date** 2010-04-14

CLIENT TransAlta **N/D** G1-09-1532
PROJECT Geotechnical study - Wind energy converters (WEC)
LOCATION St-Valentin **NO. LAB.** 36538

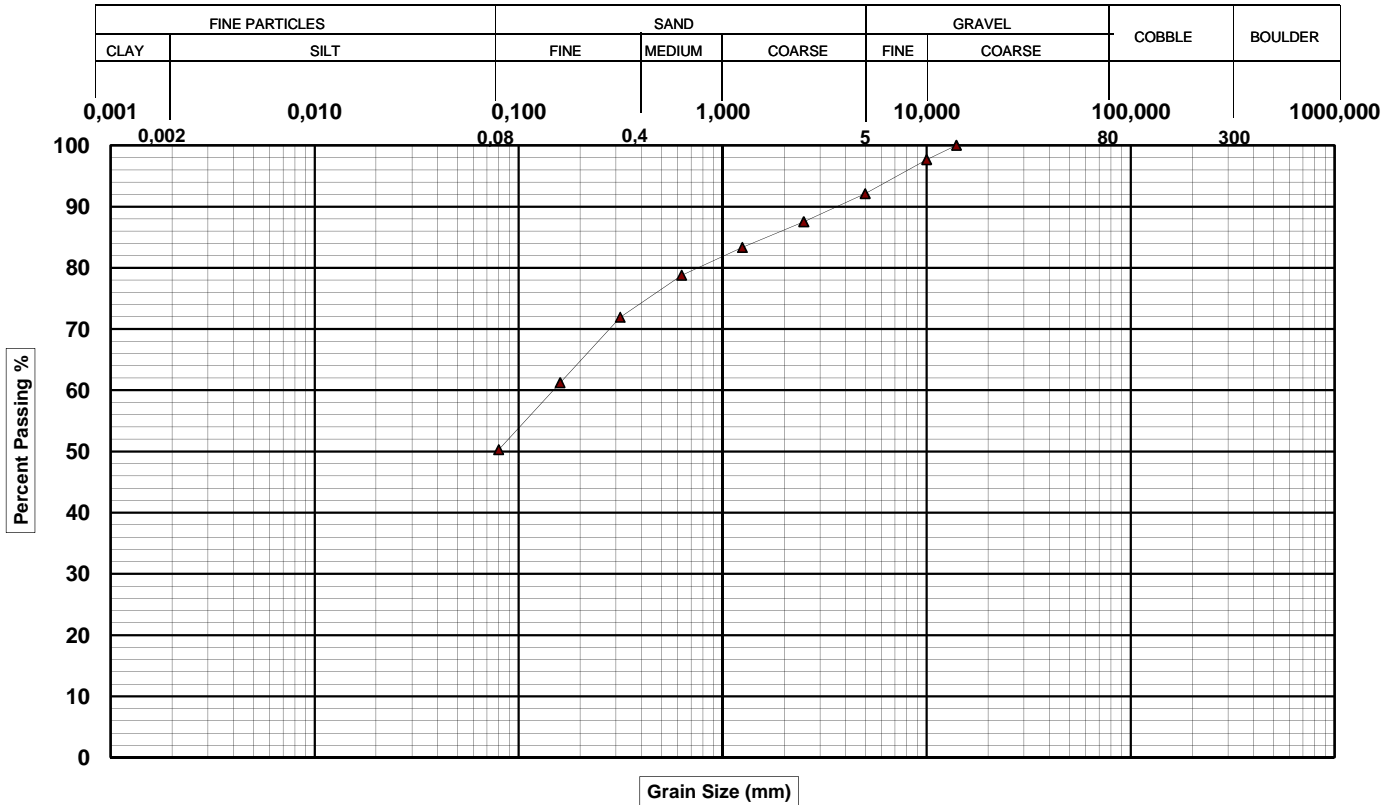

GRAIN-SIZE DISTRIBUTION					
Fine Particles		Coarse Particles			
Clay (%)	Silt (%)	Sand (%)	Gravel (%)	Cobble (%)	Boulder (%)
-	50,3	41,8	7,9	0,0	0,0

D₁₀ (mm)	D₃₀ (mm)	D₆₀ (mm)	C_u	C_c	W_n (%)
N/A	N/A	0,16	N/A	N/A	11

PERCENT PASSING					
(mm)	(%)	(mm)	(%)	(mm)	(%)
80,00	100	2,500	88		
56,00	100	1,250	83		
40,00	100	0,630	79		
31,50	100	0,315	72		
20,00	100	0,160	61		
14,00	100	0,080	50,3		
10,00	98				
5,00	92				

SAMBLE IDENTIFICATION	
Sample	10BH-16 (SS-03)
Depth	1,52 - 2,13 m
Soil Description	
Silt and sand, traces of gravel	

Prepared by Benoit St-Pierre **Approved by** Ibrahim Ja'far, ing. **Date** 2010-04-14

CLIENT TransAlta **N/D** G1-09-1532
PROJECT Geotechnical study - wind energy converters (WEC)
LOCATION St-Valentin (Québec) **NO. LAB.** 36553

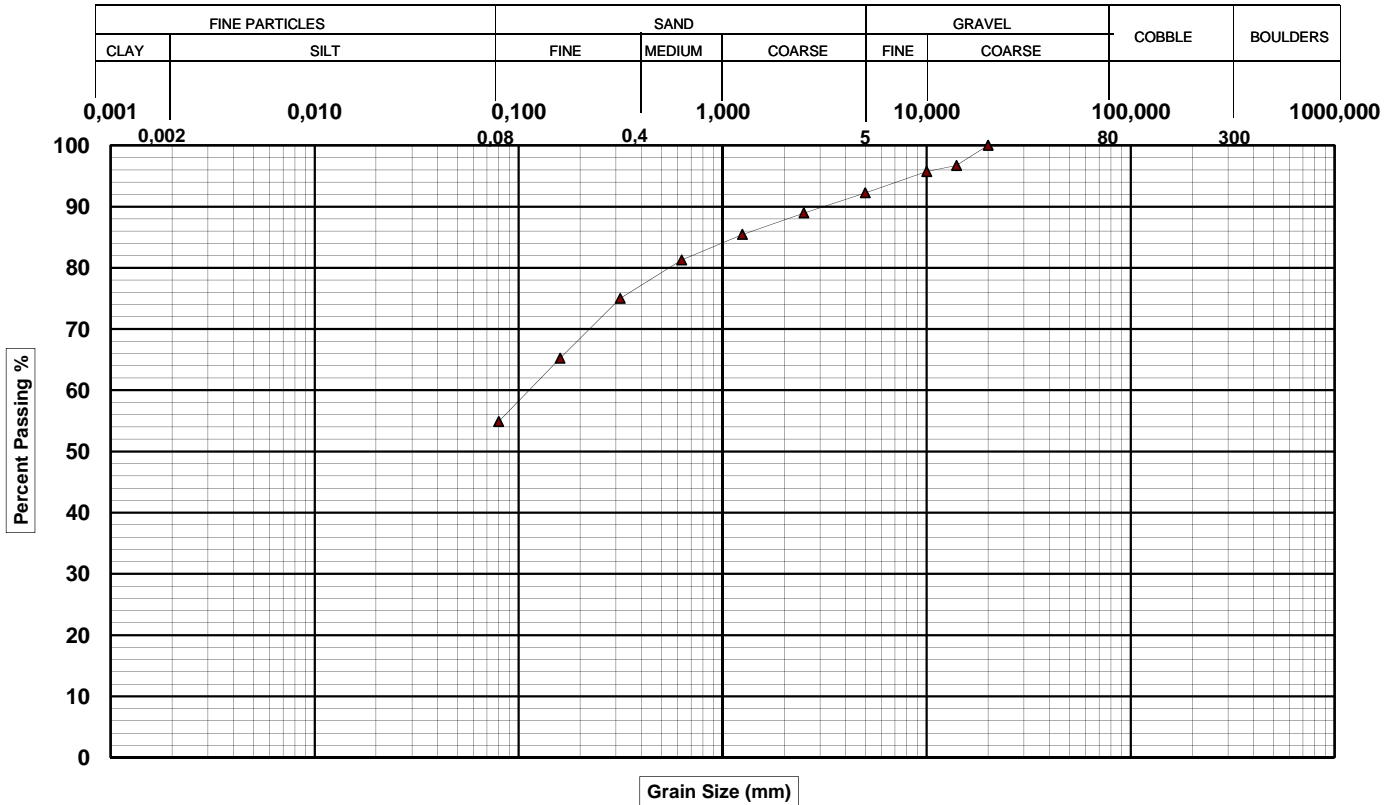

GRAIN-SIZE DISTRIBUTION					
Fine Particles		Coarse Particles			
Clay (%)	Silt (%)	Sand (%)	Gravel (%)	Cobble (%)	Boulder (%)
-	54,9	37,3	7,8	0,0	0,0

D ₁₀ (mm)	D ₃₀ (mm)	D ₆₀ (mm)	C _u	C _c	W _n (%)
N/A	N/A	0,12	N/A	N/A	4

PERCENT PASSING					
(mm)	(%)	(mm)	(%)	(mm)	(%)
80,00	100	2,500	89		
56,00	100	1,250	85		
40,00	100	0,630	81		
31,50	100	0,315	75		
20,00	100	0,160	65		
14,00	97	0,080	54,9		
10,00	96				
5,00	92				

SAMBLE IDENTIFICATION	
Sample	10BH-08 (SS-04)
Depth	2,44 - 3,05 m
Soil Description	
Silt and sand, traces of gravel	

Prepared by Benoit St-Pierre **Approved by** Ibrahim Ja'far, ing. **Date** 2010-04-14

CLIENT TransAlta **N/D** G1-09-1532
PROJECT Geotechnical study - wind energy converters (WEC)
LOCATION St-Valentin (Québec) **NO. LAB.** 36554

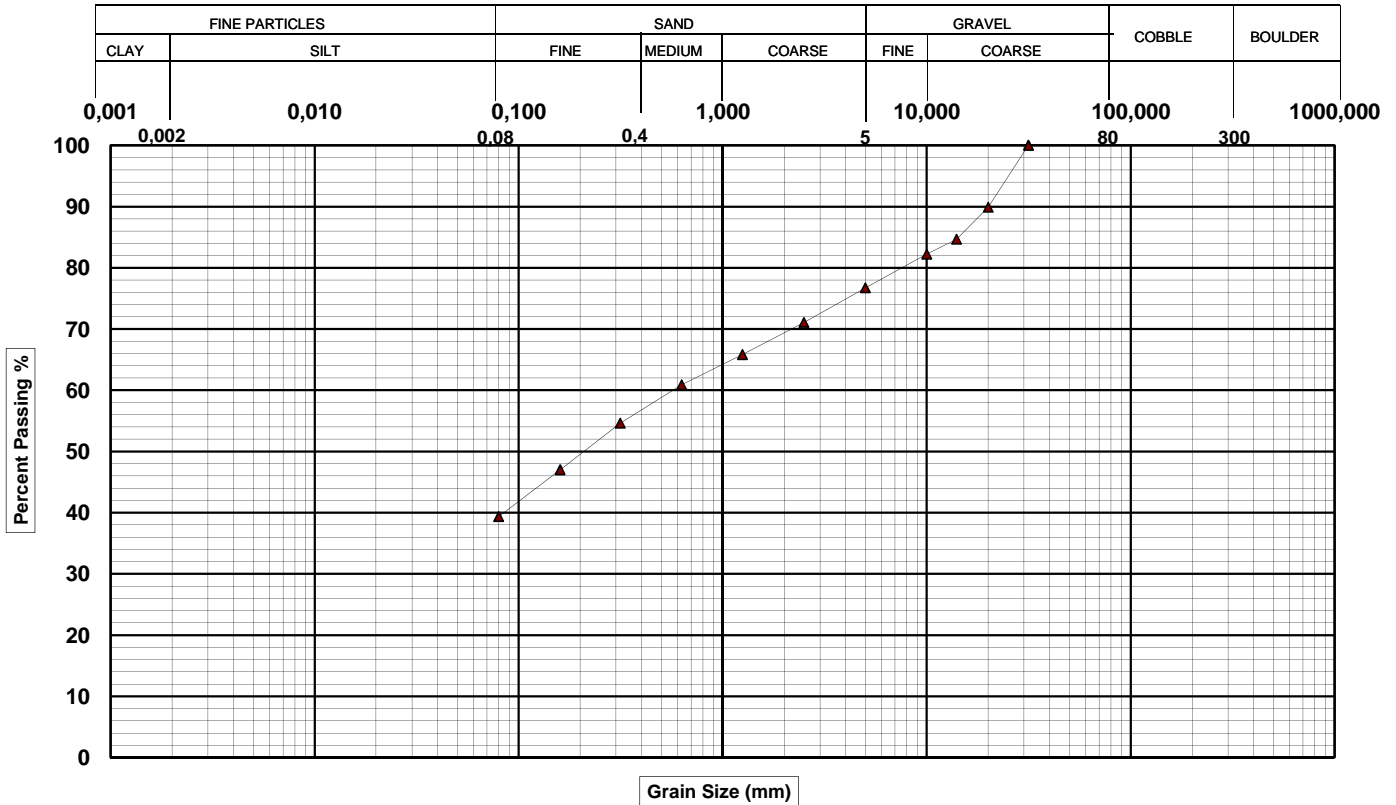

GRAIN-SIZE DISTRIBUTION					
Fine Particles		Coarse Particles			
Clay (%)	Silt (%)	Sand (%)	Gravel (%)	Cobble (%)	Boulder (%)
-	39,4	37,4	23,3	0,0	0,0

D₁₀ (mm)	D₃₀ (mm)	D₆₀ (mm)	C_u	C_c	W_n (%)
N/A	N/A	0,60	N/A	N/A	8

PERCENT PASSING					
(mm)	(%)	(mm)	(%)	(mm)	(%)
80,00	100	2,500	71		
56,00	100	1,250	66		
40,00	100	0,630	61		
31,50	100	0,315	55		
20,00	90	0,160	47		
14,00	85	0,080	39,4		
10,00	82				
5,00	77				

SAMBLE IDENTIFICATION	
Sample	10BH-07 (SS-09)
Depth	7,01 - 7,62 m
Soil Description	
Gravelly silt and sand	

Prepared by Benoit St-Pierre **Approved by** Ibrahim Ja'far, ing. **Date** 2010-04-14

CLIENT TransAlta **N/D** G1-09-1532
PROJECT Geotechnical study - wind energy converters (WEC)
LOCATION St-Valentin (Québec) **NO. LAB.** 36552

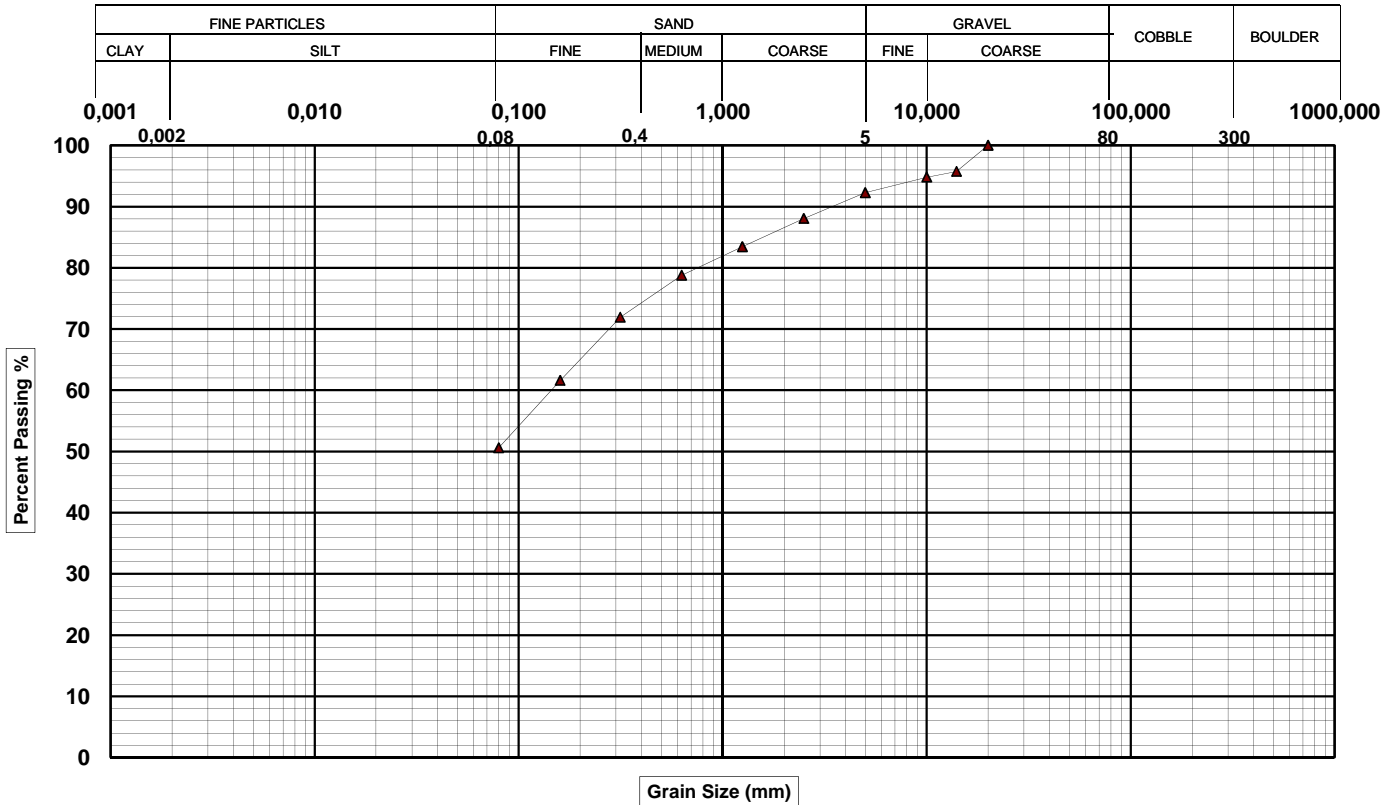

GRAIN-SIZE DISTRIBUTION					
Fine Particles		Coarse Particles			
Clay (%)	Silt (%)	Sand (%)	Gravel (%)	Cobble (%)	Boulder (%)
-	50,6	41,7	7,7	0,0	0,0

D₁₀ (mm)	D₃₀ (mm)	D₆₀ (mm)	C_u	C_c	W_n (%)
N/A	N/A	0,15	N/A	N/A	11

PERCENT PASSING					
(mm)	(%)	(mm)	(%)	(mm)	(%)
80,00	100	2,500	88		
56,00	100	1,250	83		
40,00	100	0,630	79		
31,50	100	0,315	72		
20,00	100	0,160	62		
14,00	96	0,080	50,6		
10,00	95				
5,00	92				

SAMBLE IDENTIFICATION	
Sample	10BH-07 (SS-02)
Depth	0,61 - 1,22 m
Soil Description	
Silt and sand, traces of gravel	

Prepared by Benoit St-Pierre **Approved by** Ibrahim Ja'far, ing. **Date** 2010-04-14

CLIENT	TransAlta	N/D G1-09-1532
PROJECT	Geotechnical study - wind energy converters (WEC)	
LOCATION	St-Valentin (Québec)	NO. LAB. 36550

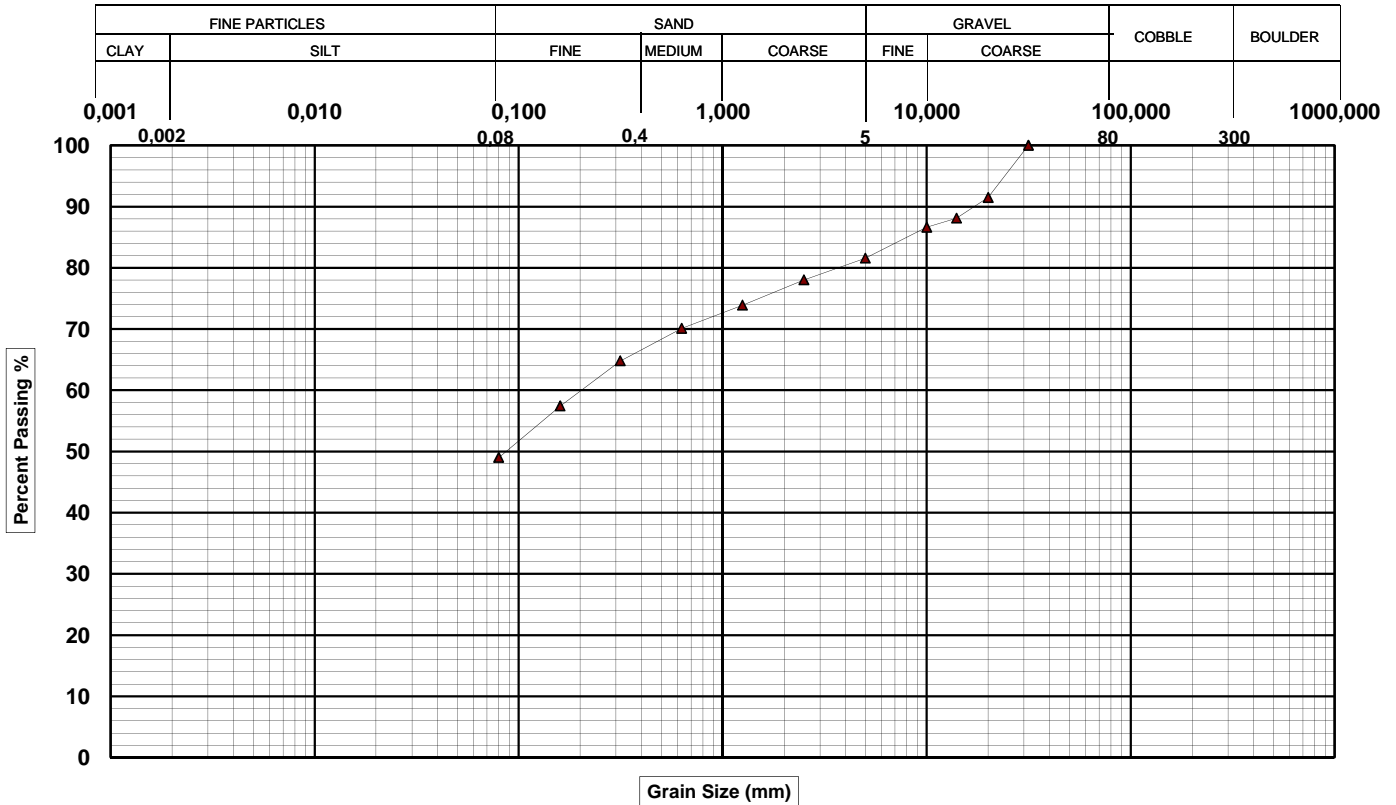

GRAIN-SIZE DISTRIBUTION					
Fine Particles		Coarse Particles			
Clay (%)	Silt (%)	Sand (%)	Gravel (%)	Cobble (%)	Boulder (%)
-	49,0	32,6	18,4	0,0	0,0

D ₁₀ (mm)	D ₃₀ (mm)	D ₆₀ (mm)	C _u	C _c	W _n (%)
N/A	N/A	0,20	N/A	N/A	7

PERCENT PASSING					
(mm)	(%)	(mm)	(%)	(mm)	(%)
80,00	100	2,500	78		
56,00	100	1,250	74		
40,00	100	0,630	70		
31,50	100	0,315	65		
20,00	91	0,160	57		
14,00	88	0,080	49,0		
10,00	87				
5,00	82				

SAMBLE IDENTIFICATION	
Sample	10BH-18 (SS-07)
Depth	5,18 - 5,74 m
Soil Description	
Sandy silt some gravel	

Prepared by Benoit St-Pierre	Approved by Ibrahim Ja'far, ing.	Date 2010-04-14
-------------------------------------	---	------------------------

CLIENT TransAlta **N/D** G1-09-1532
PROJECT Geotechnical study - wind energy converters (WEC)
LOCATION St-Valentin (Québec) **NO. LAB.** 36548

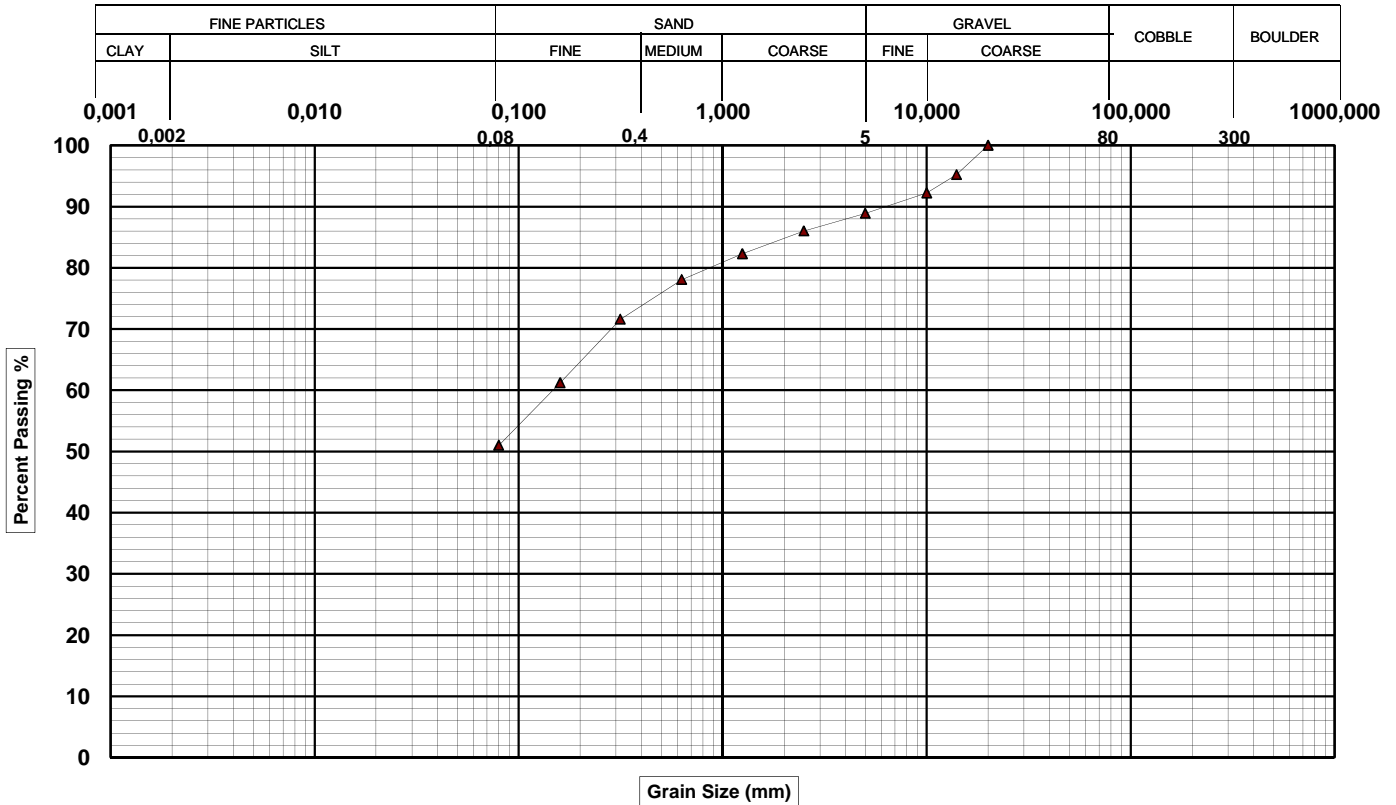

GRAIN-SIZE DISTRIBUTION					
Fine Particles		Coarse Particles			
Clay (%)	Silt (%)	Sand (%)	Gravel (%)	Cobble (%)	Boulder (%)
-	51,0	37,9	11,1	0,0	0,0

D₁₀ (mm)	D₃₀ (mm)	D₆₀ (mm)	C_u	C_c	W_n (%)
N/A	N/A	0,15	N/A	N/A	10

PERCENT PASSING					
(mm)	(%)	(mm)	(%)	(mm)	(%)
80,00	100	2,500	86		
56,00	100	1,250	82		
40,00	100	0,630	78		
31,50	100	0,315	72		
20,00	100	0,160	61		
14,00	95	0,080	51,0		
10,00	92				
5,00	89				

SAMBLE IDENTIFICATION	
Sample	10BH-18 (SS-02)
Depth	0,61 - 1,22 m
Soil Description	
Silt and sand, some gravel	

Prepared by Benoit St-Pierre **Approved by** Ibrahim Ja'far, ing. **Date** 2010-04-14

CLIENT TransAlta **N/D** G1-09-1532
PROJECT Geotechnical study - wind energy converters (WEC)
LOCATION St-Valentin (Québec) **NO. LAB.** 36549

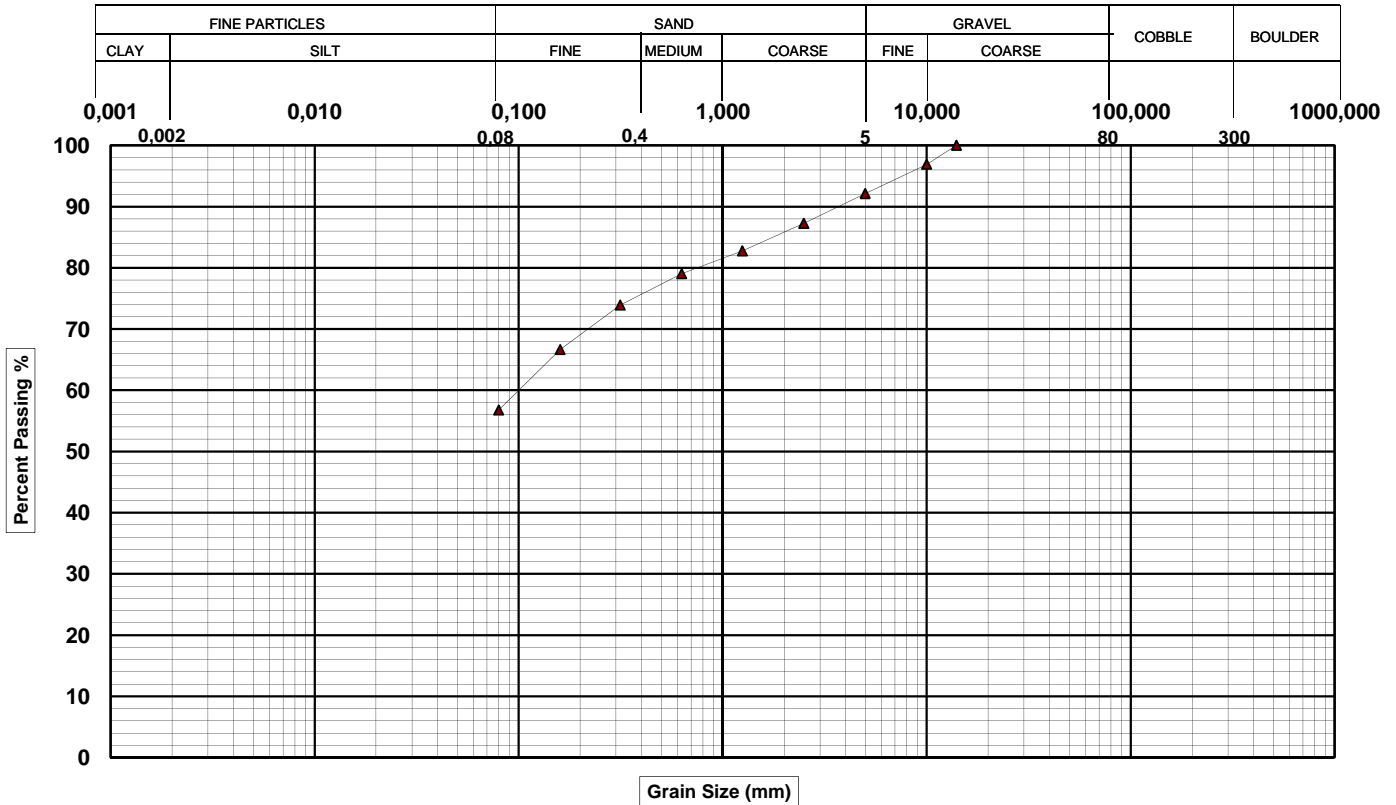

GRAIN-SIZE DISTRIBUTION

Fine Particles		Coarse Particles			
Clay (%)	Silt (%)	Sand (%)	Gravel (%)	Cobble (%)	Boulder (%)
-	56,8	35,3	7,9	0,0	0,0

D ₁₀ (mm)	D ₃₀ (mm)	D ₆₀ (mm)	C _u	C _c	W _n (%)
N/A	N/A	0,10	N/A	N/A	10

PERCENT PASSING

(mm)	(%)	(mm)	(%)	(mm)	(%)
80,00	100	2,500	87		
56,00	100	1,250	83		
40,00	100	0,630	79		
31,50	100	0,315	74		
20,00	100	0,160	67		
14,00	100	0,080	56,8		
10,00	97				
5,00	92				

SAMBLE IDENTIFICATION

Sample	10BH-18 (SS-05)
Depth	3,35 - 3,96 m
Soil Description	
Silt and sand, traces of gravel	

Prepared by Benoit St-Pierre **Approved by** Ibrahim Ja'far, ing. **Date** 2010-04-14

CLIENT TransAlta **N/D** G1-09-1532
PROJECT Geotechnical study - Wind energy converters (WEC)
LOCATION St-Valentin (Québec) **NO. LAB.** 36887

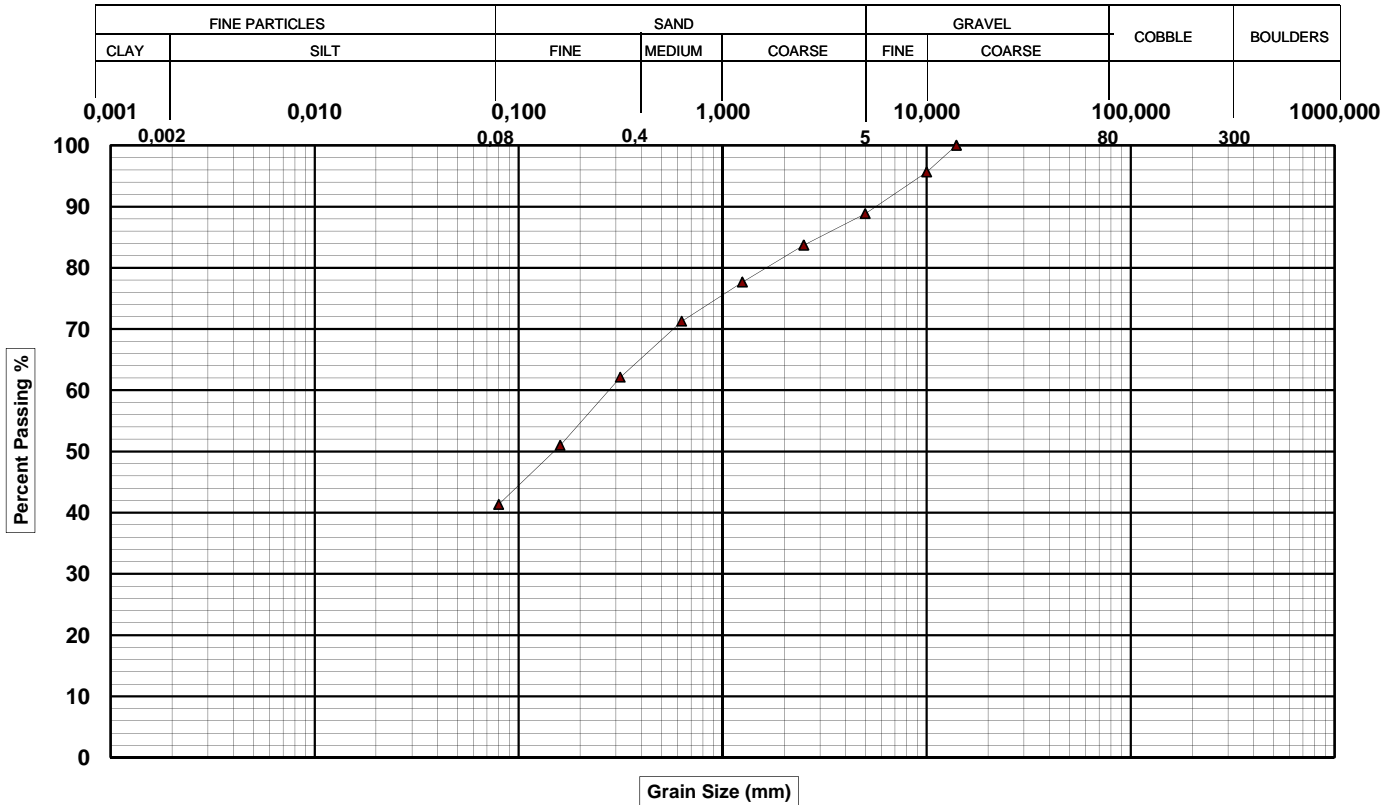

GRAIN-SIZE DISTRIBUTION

Fine Particles		Coarse Particles			
Clay (%)	Silt (%)	Sand (%)	Gravel (%)	Cobble (%)	Boulder (%)
-	41,3	47,5	11,2	0,0	0,0

D₁₀ (mm)	D₃₀ (mm)	D₆₀ (mm)	C_u	C_c	W_n (%)
N/A	N/A	0,29	N/A	N/A	11

PERCENT PASSING

(mm)	(%)	(mm)	(%)	(mm)	(%)
80,00	100	2,500	84		
56,00	100	1,250	78		
40,00	100	0,630	71		
31,50	100	0,315	62		
20,00	100	0,160	51		
14,00	100	0,080	41,3		
10,00	96				
5,00	89				

SAMBLE IDENTIFICATION

Sample	10BH-27 (SS-06)
Depth	5,18 - 5,79 m
Soil Description	
Sand and silt, some gravel	

Prepared by Benoit St-Pierre, tech. **Approved by** Ibrahim Ja'far, ing. **Date** 2010-05-05

CLIENT TransAlta **N/D** G1-09-1532
PROJECT Geotechnical study - Wind energy converters (WEC)
LOCATION St-Valentin (Québec) **NO. LAB.** 36888

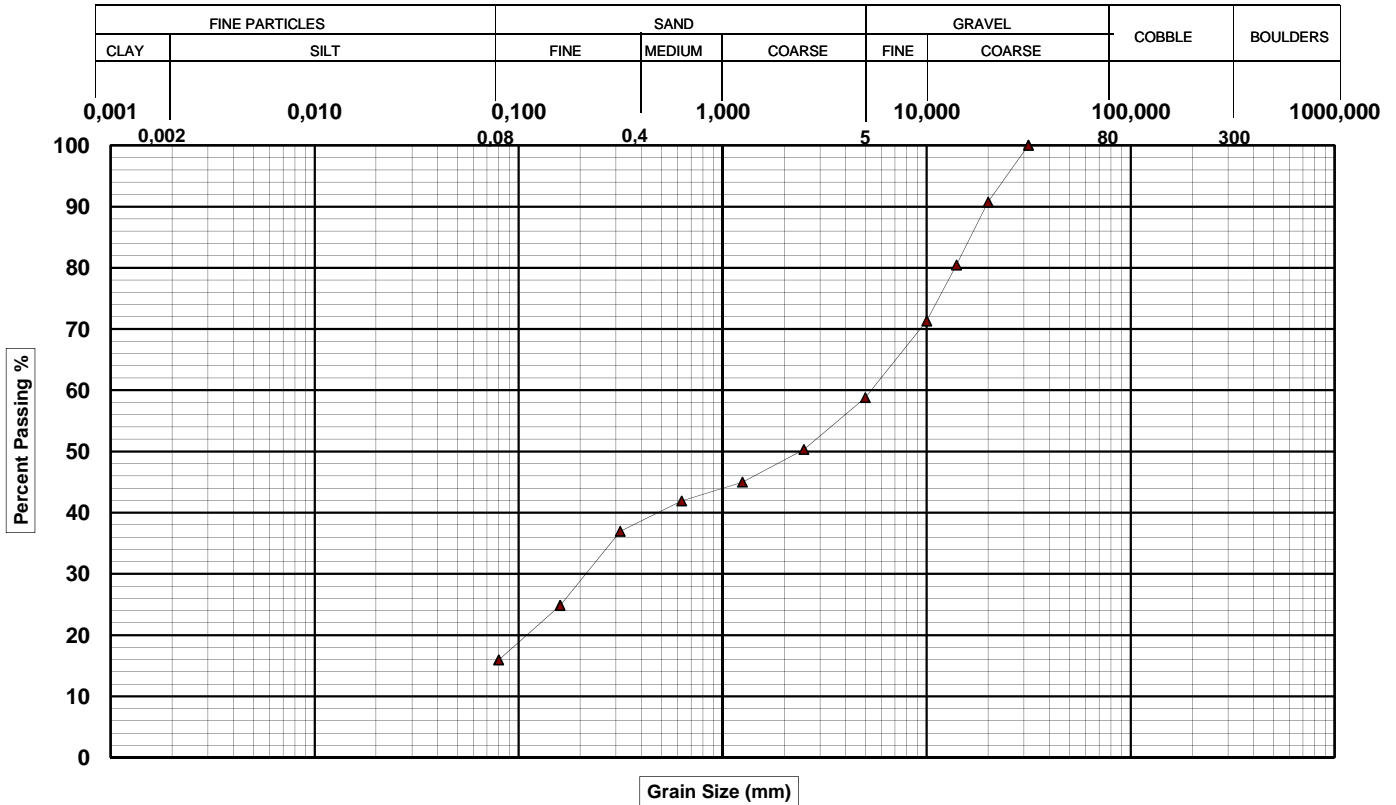

GRAIN-SIZE DISTRIBUTION

Fine Particles		Coarse Particles			
Clay (%)	Silt (%)	Sand (%)	Gravel (%)	Cobble (%)	Boulder (%)
-	16,0	42,8	41,2	0,0	0,0

D₁₀ (mm)	D₃₀ (mm)	D₆₀ (mm)	C_u	C_c	W_n (%)
N/A	0,22	5,30	N/A	N/A	9

PERCENT PASSING

(mm)	(%)	(mm)	(%)	(mm)	(%)
80,00	100	2,500	50		
56,00	100	1,250	45		
40,00	100	0,630	42		
31,50	100	0,315	37		
20,00	91	0,160	25		
14,00	80	0,080	16,0		
10,00	71				
5,00	59				

SAMBLE IDENTIFICATION

Sample	10BH-27 (SS-10)
Depth	9,14 - 9,75 m
Soil Description	
sand and gravel, some silt	

Prepared by Benoit St-Pierre, tech. **Approved by** Ibrahim Ja'far, ing. **Date** 2010-05-05

CLIENT	TransAlta	N/D G1-09-1532
PROJECT	Geotechnical study - Wind energy converters (WEC)	
LOCATION	St-Valentin (Québec)	NO. LAB. 36891

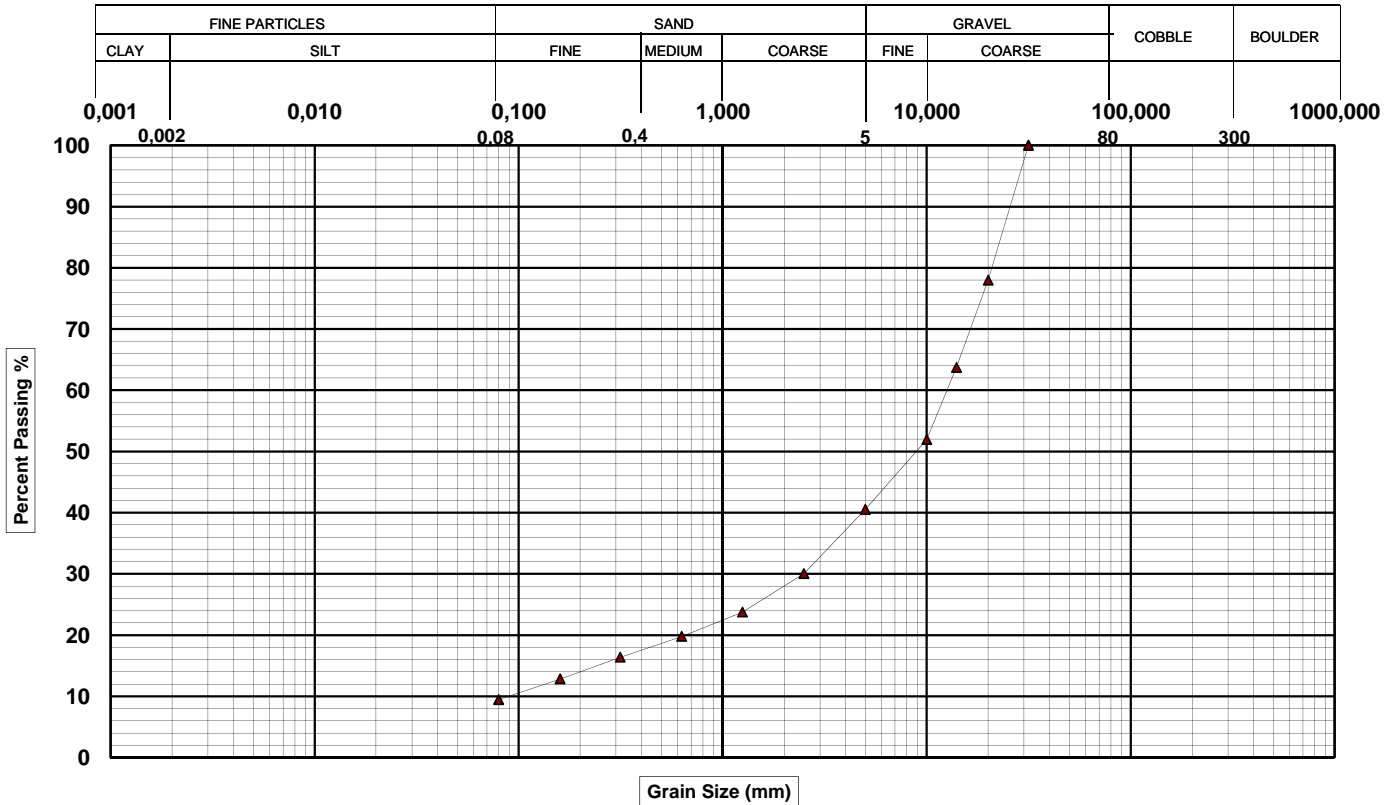

GRAIN-SIZE DISTRIBUTION					
Fine Particles			Coarse Particles		
Clay (%)	Silt (%)	Sand (%)	Gravel (%)	Cobble (%)	Boulder (%)
-	9,4	31,1	59,5	0,0	0,0

D₁₀ (mm)	D₃₀ (mm)	D₆₀ (mm)	C_u	C_c	W_n (%)
0,090	2,50	13,00	144,44	5,34	7

PERCENT PASSING					
(mm)	(%)	(mm)	(%)	(mm)	(%)
80,00	100	2,500	30		
56,00	100	1,250	24		
40,00	100	0,630	20		
31,50	100	0,315	16		
20,00	78	0,160	13		
14,00	64	0,080	9,4		
10,00	52				
5,00	41				

SAMBLE IDENTIFICATION	
Sample	10BH-28A (SS-08)
Depth	6,48 - 7,09 m
Soil Description	
Sandy gravel, traces of silt	

Prepared by Benoit St-Pierre, tech. **Approved by** Ibrahim Ja'far, ing. **Date** 2010-05-05

CLIENT TransAlta **N/D** G1-09-1532
PROJECT Geotechnical study - Wind energy converters (WEC)
LOCATION St-Valentin (Québec) **NO. LAB.** 36892

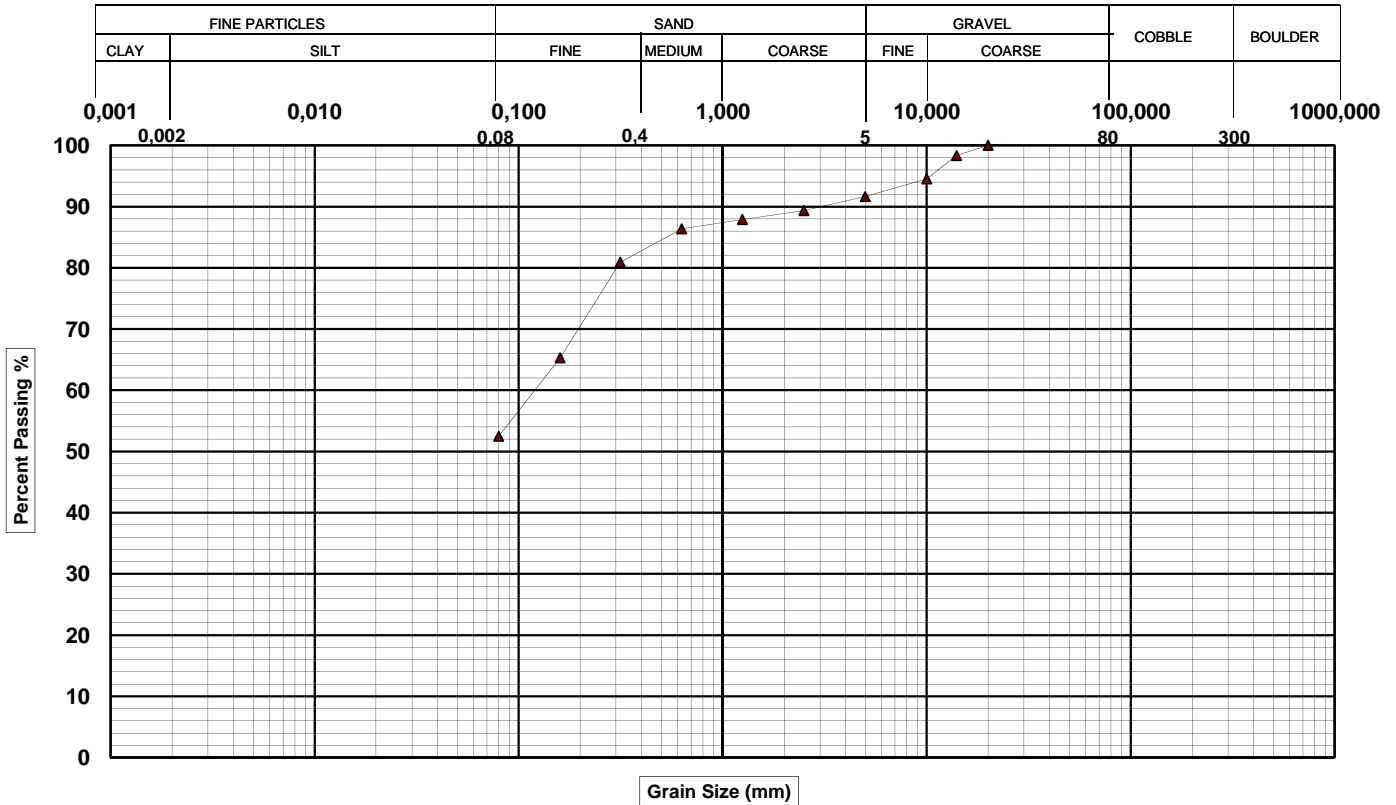

GRAIN-SIZE DISTRIBUTION					
Fine Particles		Coarse Particles			
Clay (%)	Silt (%)	Sand (%)	Gravel (%)	Cobble (%)	Boulder (%)
-	52,5	39,2	8,4	0,0	0,0

D ₁₀ (mm)	D ₃₀ (mm)	D ₆₀ (mm)	C _u	C _c	W _n (%)
N/A	N/A	0,12	N/A	N/A	14

PERCENT PASSING					
(mm)	(%)	(mm)	(%)	(mm)	(%)
80,00	100	2,500	89		
56,00	100	1,250	88		
40,00	100	0,630	86		
31,50	100	0,315	81		
20,00	100	0,160	65		
14,00	98	0,080	52,5		
10,00	95				
5,00	92				

SAMBLE IDENTIFICATION	
Sample	10BH-28A (SS-11)
Depth	9,14 - 9,75 m
Soil Description	
Silt and sand, traces of gravel	

Prepared by Benoit St-Pierre, tech. **Approved by** Ibrahim Ja'far, ing. **Date** 2010-05-05

CLIENT TransAlta **N/D** G1-09-1532
PROJECT Geotechnical study - Wind energy converters (WEC)
LOCATION St-Valentin (Québec) **NO. LAB.** 36867

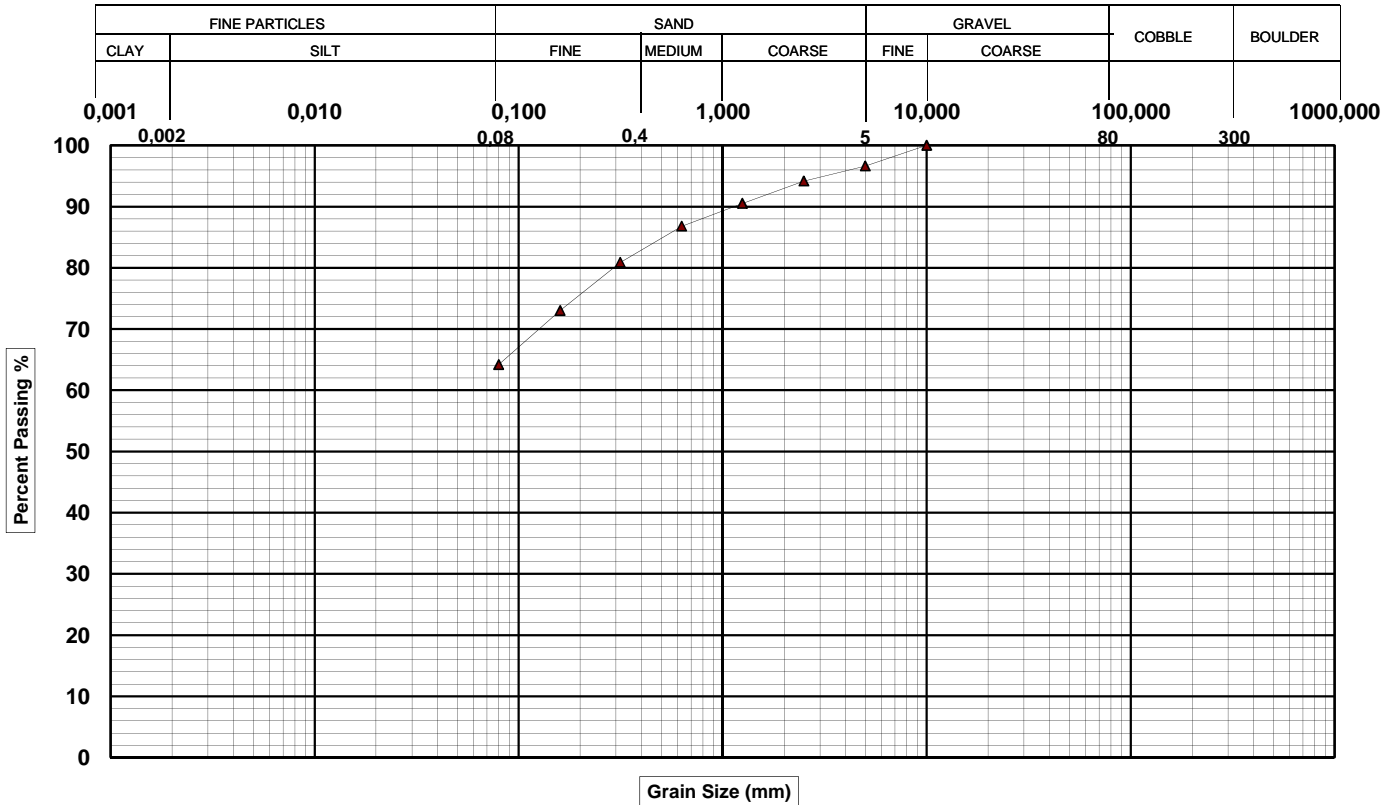

GRAIN-SIZE DISTRIBUTION					
Fine Particles		Coarse Particles			
Clay (%)	Silt (%)	Sand (%)	Gravel (%)	Cobble (%)	Boulder (%)
-	64,2	32,4	3,4	0,0	0,0

D ₁₀ (mm)	D ₃₀ (mm)	D ₆₀ (mm)	C _u	C _c	W _n (%)
N/A	N/A	N/A	N/A	N/A	12

PERCENT PASSING					
(mm)	(%)	(mm)	(%)	(mm)	(%)
80,00	100	2,500	94		
56,00	100	1,250	91		
40,00	100	0,630	87		
31,50	100	0,315	81		
20,00	100	0,160	73		
14,00	100	0,080	64,2		
10,00	100				
5,00	97				

SAMBLE IDENTIFICATION	
Sample	10BH-22 (SS-02)
Depth	0,61 - 1,22 m
Soil Description	
Sandy silt, traces of gravel	

Prepared by Benoit St-Pierre, tech. **Approved by** Ibrahim Ja'far, ing. **Date** 2010-05-04

CLIENT TransAlta **N/D** G1-09-1532
PROJECT Geotechnical study - Wind energy converters (WEC)
LOCATION St-Valentin (Québec) **NO. LAB.** 36868

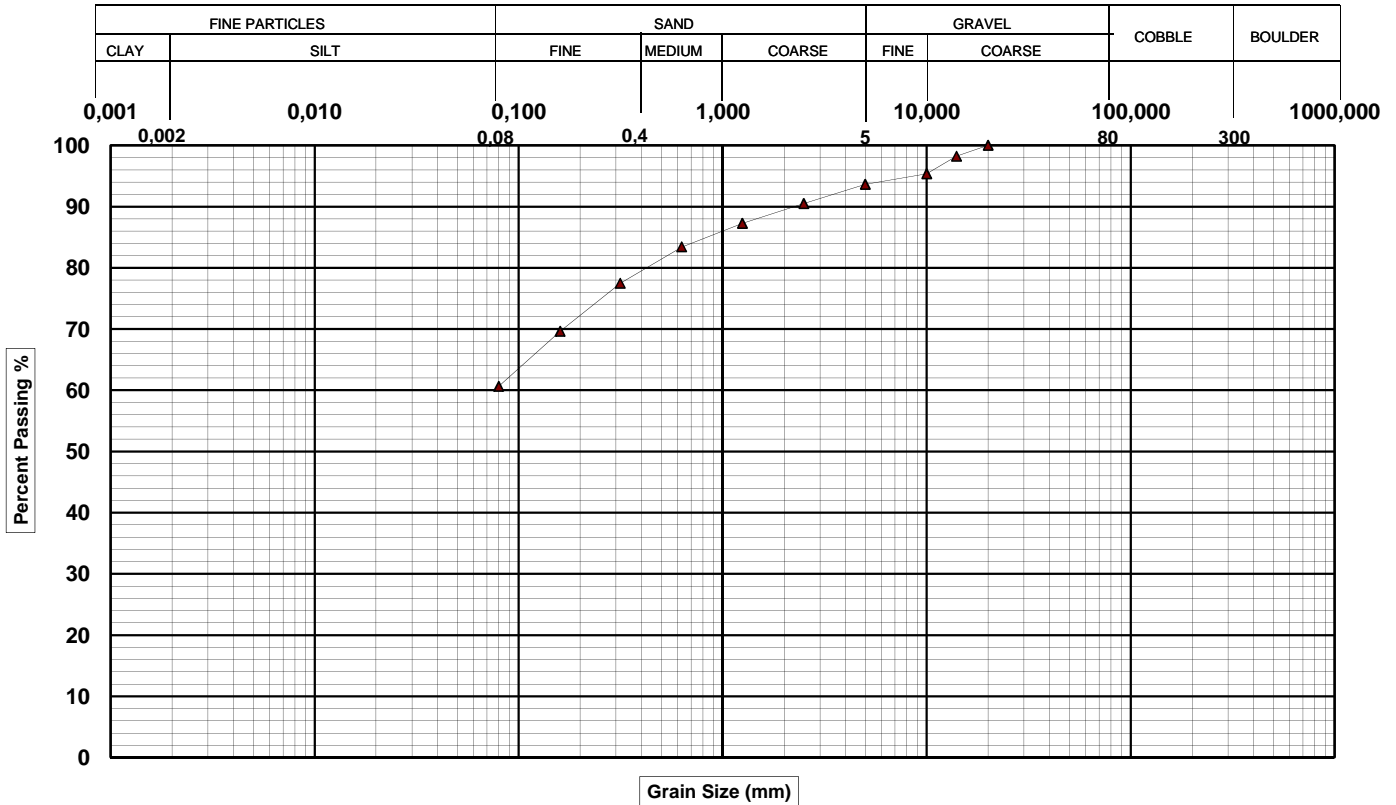

GRAIN-SIZE DISTRIBUTION					
Fine Particles		Coarse Particles			
Clay (%)	Silt (%)	Sand (%)	Gravel (%)	Cobble (%)	Boulder (%)
-	60,6	33,0	6,4	0,0	0,0

D ₁₀ (mm)	D ₃₀ (mm)	D ₆₀ (mm)	C _u	C _c	W _n (%)
N/A	N/A	N/A	N/A	N/A	15

PERCENT PASSING					
(mm)	(%)	(mm)	(%)	(mm)	(%)
80,00	100	2,500	90		
56,00	100	1,250	87		
40,00	100	0,630	83		
31,50	100	0,315	77		
20,00	100	0,160	70		
14,00	98	0,080	60,6		
10,00	95				
5,00	94				

SAMBLE IDENTIFICATION	
Sample	10BH-22 (SS-04)
Depth	2,44 - 3,05 m
Soil Description	
Sandy silt, traces of gravel	

Prepared by Benoit St-Pierre **Approved by** Ibrahim Ja'far, ing. **Date** 2010-05-04

CLIENT	TransAlta	N/D G1-09-1532
PROJECT	Geotechnical study - Wind energy converters (WEC)	
LOCATION	St-Valentin (Québec)	NO. LAB. 36869

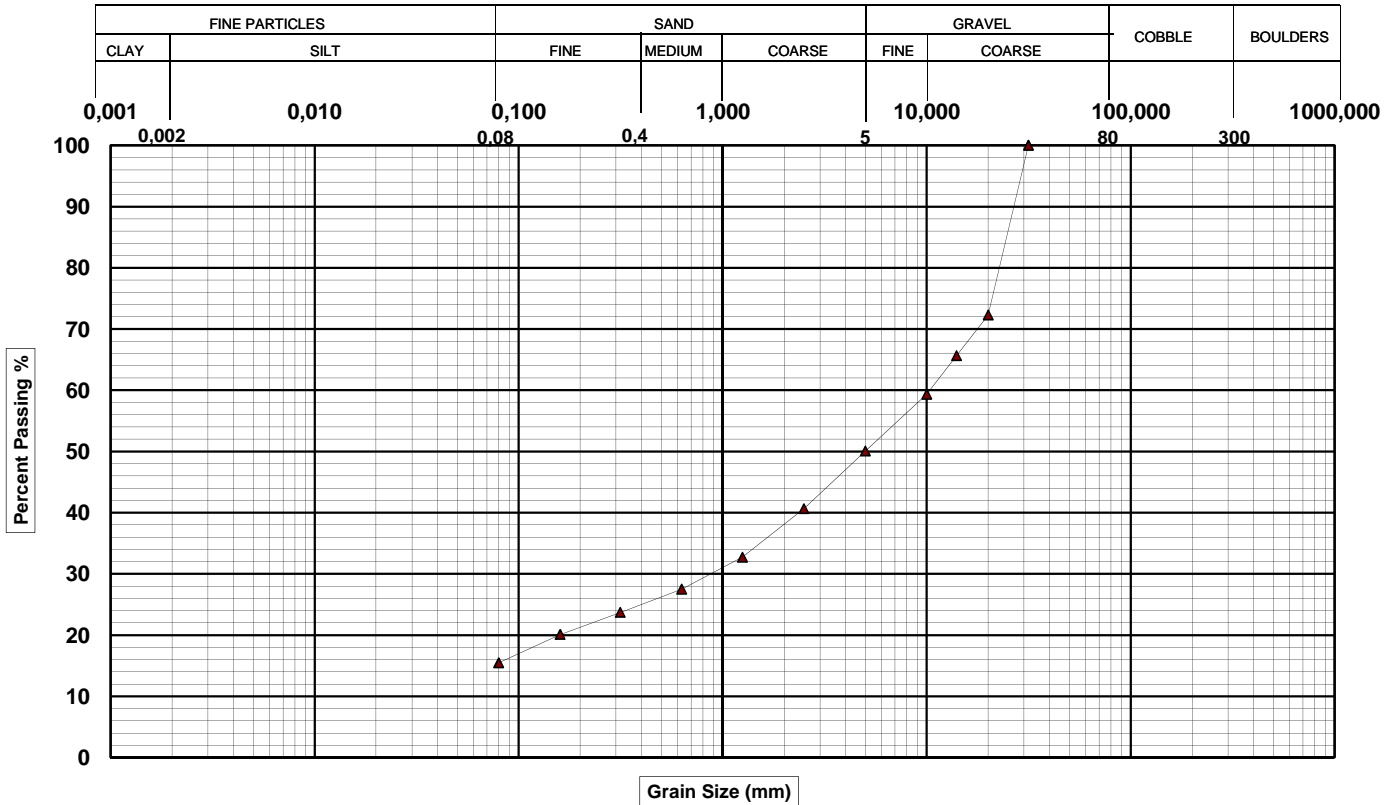

GRAIN-SIZE DISTRIBUTION					
Fine Particles			Coarse Particles		
Clay (%)	Silt (%)	Sand (%)	Gravel (%)	Cobble (%)	Boulder (%)
-	15,5	34,6	49,9	0,0	0,0

D ₁₀ (mm)	D ₃₀ (mm)	D ₆₀ (mm)	C _u	C _c	W _n (%)
N/A	0,90	N/A	N/A	N/A	6

PERCENT PASSING					
(mm)	(%)	(mm)	(%)	(mm)	(%)
80,00	100	2,500	41		
56,00	100	1,250	33		
40,00	100	0,630	27		
31,50	100	0,315	24		
20,00	72	0,160	20		
14,00	66	0,080	15,5		
10,00	59				
5,00	50				

SAMBLE IDENTIFICATION	
Sample	10BH-22 (SS-08)
Depth	6,10 - 6,71 m
Soil Description	
Gravel and sand, some silt	

Prepared by Benoit St-pierre Approved by Ibrahim Ja'far, ing. Date 2010-05-04

CLIENT TransAlta **N/D** G1-09-1532
PROJECT Geotechnical study - Wind energy converters (WEC)
LOCATION St-Valentin (Québec) **NO. LAB.** 36873

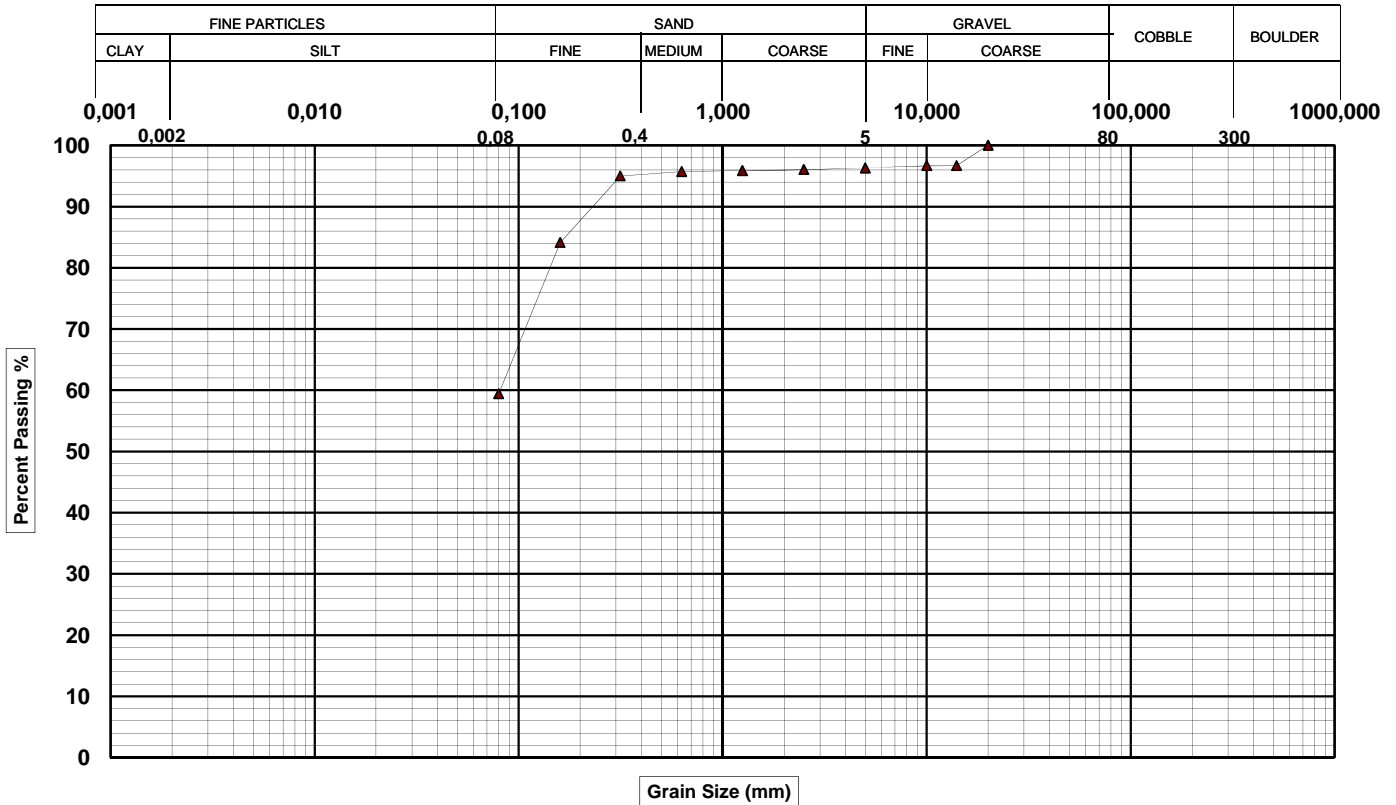

GRAIN-SIZE DISTRIBUTION					
Fine Particles		Coarse Particles			
Clay (%)	Silt (%)	Sand (%)	Gravel (%)	Cobble (%)	Boulder (%)
-	59,4	36,9	3,7	0,0	0,0

D ₁₀ (mm)	D ₃₀ (mm)	D ₆₀ (mm)	C _u	C _c	W _n (%)
N/A	N/A	0,08	N/A	N/A	15

PERCENT PASSING					
(mm)	(%)	(mm)	(%)	(mm)	(%)
80,00	100	2,500	96		
56,00	100	1,250	96		
40,00	100	0,630	96		
31,50	100	0,315	95		
20,00	100	0,160	84		
14,00	97	0,080	59,4		
10,00	97				
5,00	96				

SAMBLE IDENTIFICATION	
Sample	10BH-28 (SS-09)
Depth	7,01 - 7,62 m
Soil Description	
Silt and sand, traces of gravel	

Prepared by Benoit St-Pierre, tech. **Approved by** Ibrahim Ja'far, ing. **Date** 2010-05-04

CLIENT TransAlta **N/D** G1-09-1532
PROJECT Geotechnical study - Wind energy converters (WEC)
LOCATION St-Valentin (Québec) **NO. LAB.** 36880

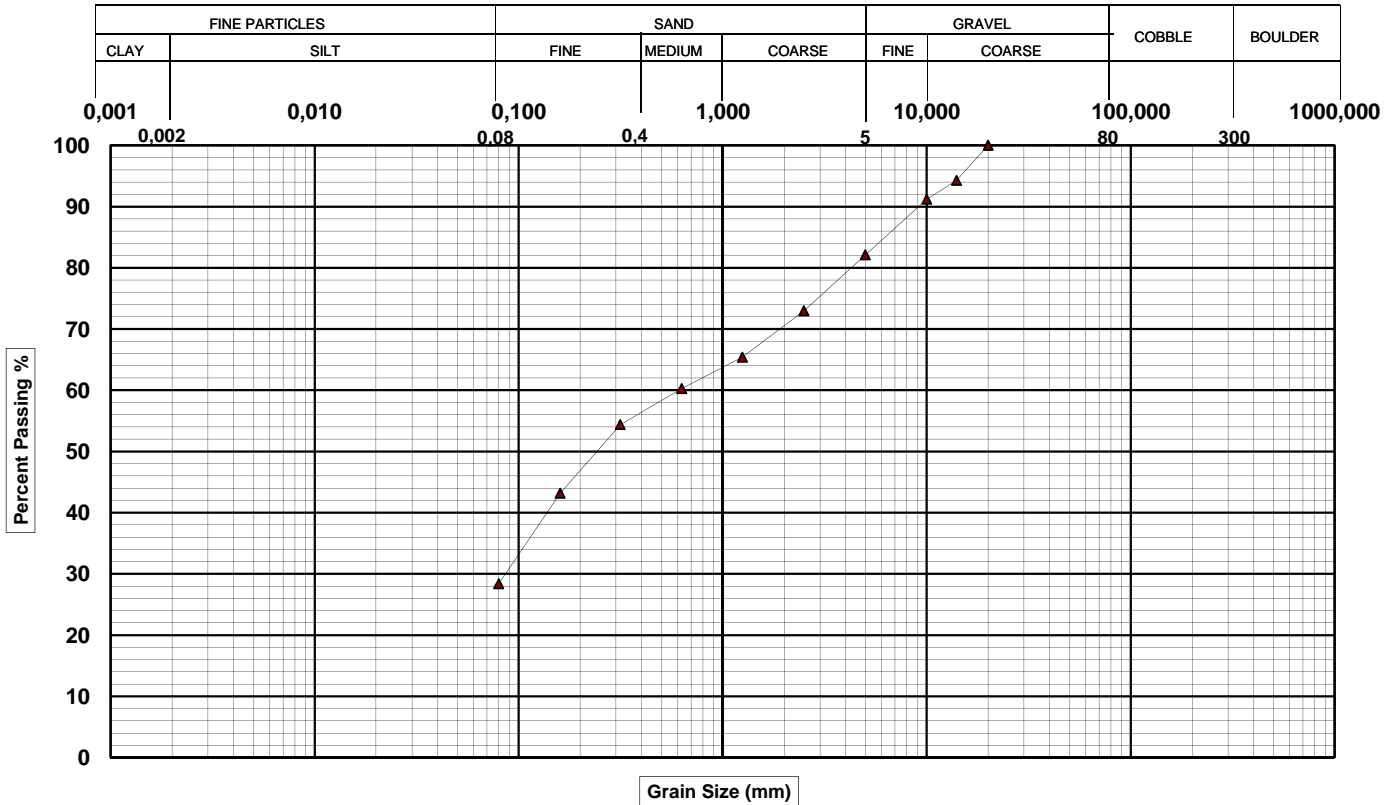

GRAIN-SIZE DISTRIBUTION					
Fine Particles		Coarse Particles			
Clay (%)	Silt (%)	Sand (%)	Gravel (%)	Cobble (%)	Boulder (%)
-	28,4	53,7	17,9	0,0	0,0

D₁₀ (mm)	D₃₀ (mm)	D₆₀ (mm)	C_u	C_c	W_n (%)
N/A	0,09	0,60	N/A	N/A	9

PERCENT PASSING					
(mm)	(%)	(mm)	(%)	(mm)	(%)
80,00	100	2,500	73		
56,00	100	1,250	65		
40,00	100	0,630	60		
31,50	100	0,315	54		
20,00	100	0,160	43		
14,00	94	0,080	28,4		
10,00	91				
5,00	82				

SAMBLE IDENTIFICATION	
Sample	10BH-31 (SS-08)
Depth	7,09 - 7,70 m
Soil Description	
Silty sand, trace of gravel	

Prepared by Benoit St-Pierre **Approved by** Ibrahim Ja'far, ing. **Date** 2010-05-04

CLIENT	TransAlta	N/D G1-09-1532
PROJECT	Geotechnical study - Wind energy converters (WEC)	
LOCATION	St-Valentin (Québec)	NO. LAB. 36884

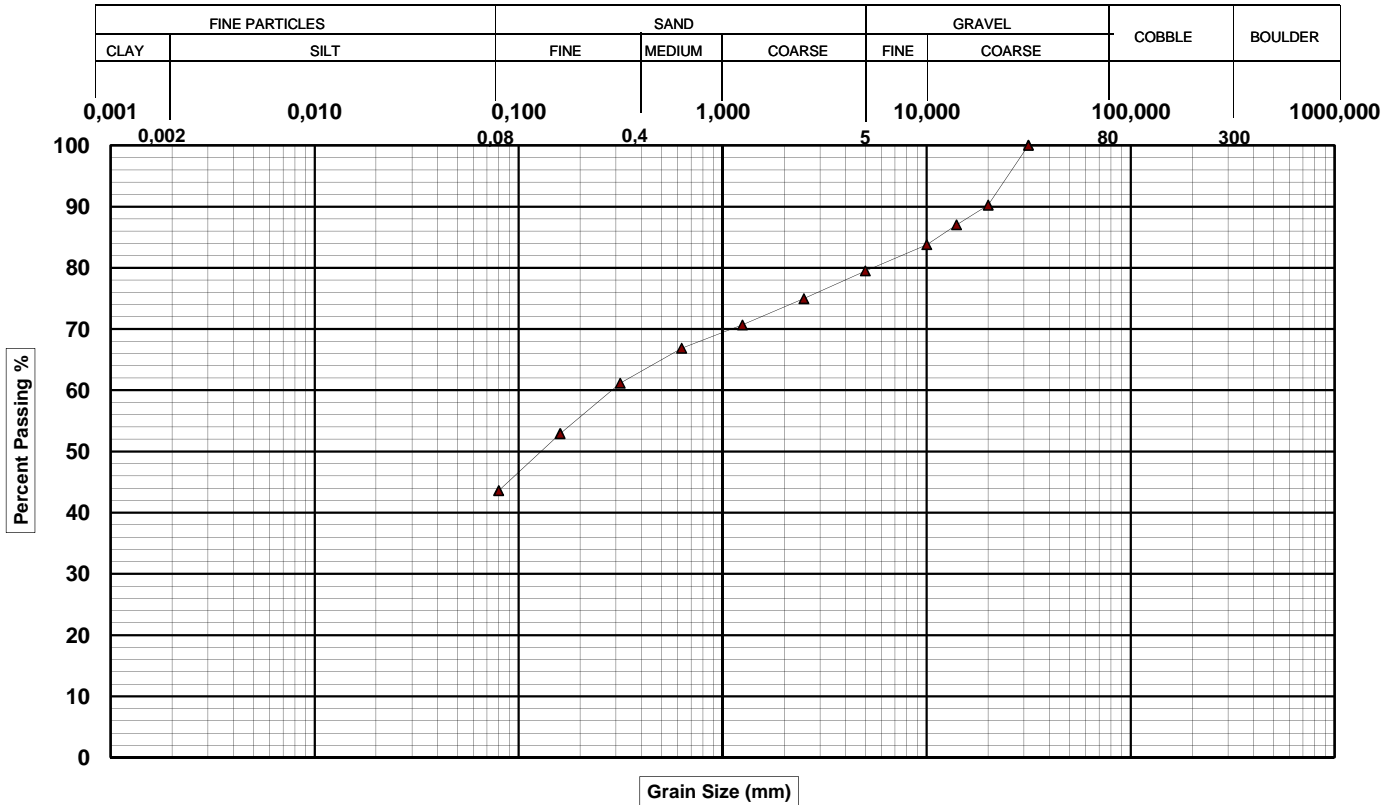

GRAIN-SIZE DISTRIBUTION					
Fine Particles		Coarse Particles			
Clay (%)	Silt (%)	Sand (%)	Gravel (%)	Cobble (%)	Boulder (%)
-	43,6	35,9	20,5	0,0	0,0

D₁₀ (mm)	D₃₀ (mm)	D₆₀ (mm)	C_u	C_c	W_n (%)
N/A	N/A	0,30	N/A	N/A	9

PERCENT PASSING					
(mm)	(%)	(mm)	(%)	(mm)	(%)
80,00	100	2,500	75		
56,00	100	1,250	71		
40,00	100	0,630	67		
31,50	100	0,315	61		
20,00	90	0,160	53		
14,00	87	0,080	43,6		
10,00	84				
5,00	79				

SAMBLE IDENTIFICATION	
Sample	10BH-31A (SS-08)
Depth	6,10 - 6,71 m
Soil Description	
Gravelly silt and sand	

Prepared by Benoit St-Pierre, tech. Approved by Ibrahim Ja'far, ing. Date 2010-05-04

CLIENT TransAlta **N/D** G1-09-1532
PROJECT Geotechnical study - Wind energy converters (WEC)
LOCATION St-Valentin (Québec) **NO. LAB.** 36929

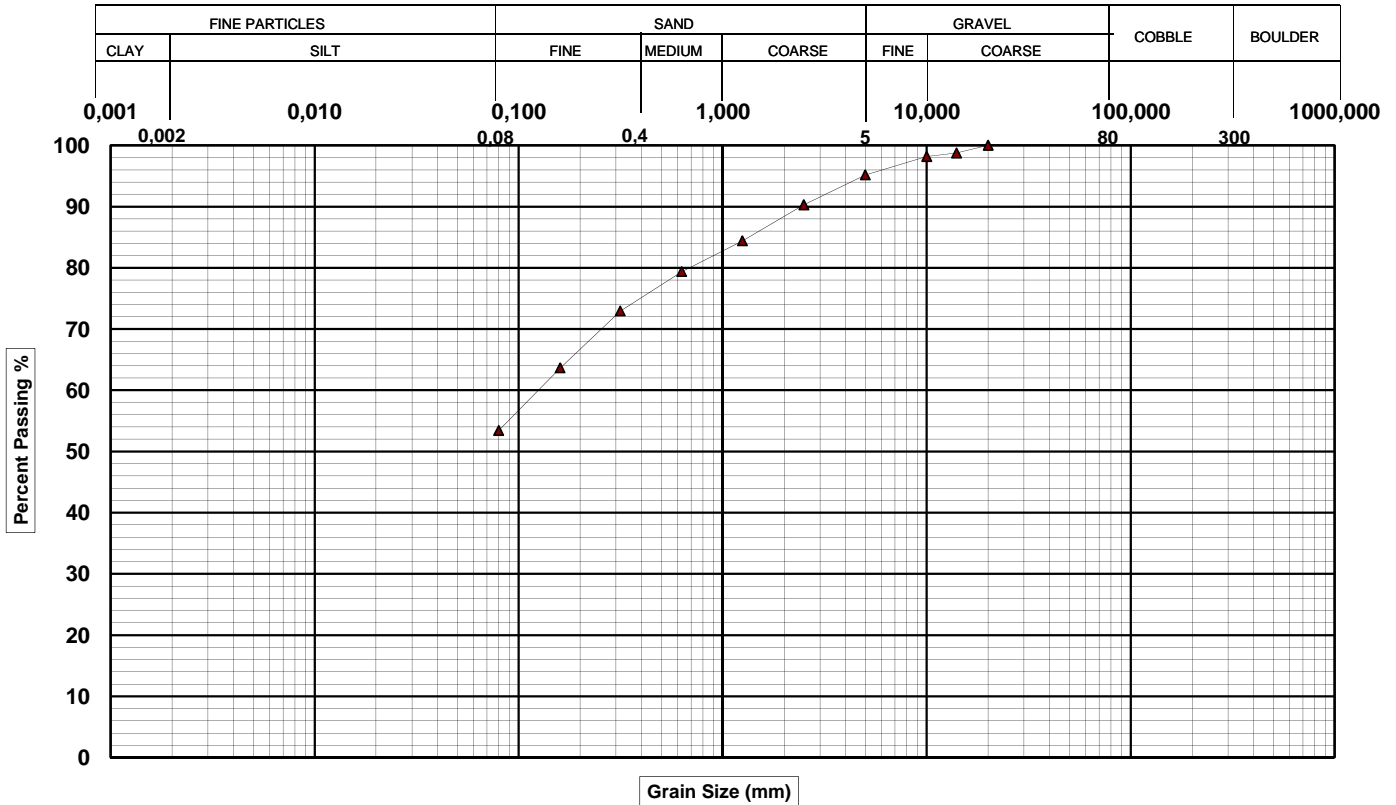

GRAIN-SIZE DISTRIBUTION

Fine Particles		Coarse Particles			
Clay (%)	Silt (%)	Sand (%)	Gravel (%)	Cobble (%)	Boulder (%)
-	53,4	41,7	4,8	0,0	0,0

D₁₀ (mm)	D₃₀ (mm)	D₆₀ (mm)	C_u	C_c	W_n (%)
N/A	N/A	0,13	N/A	N/A	13

PERCENT PASSING

(mm)	(%)	(mm)	(%)	(mm)	(%)
80,00	100	2,500	90		
56,00	100	1,250	84		
40,00	100	0,630	79		
31,50	100	0,315	73		
20,00	100	0,160	64		
14,00	99	0,080	53,4		
10,00	98				
5,00	95				

SAMBLE IDENTIFICATION

Sample	10BH-37 (SS-03)
Depth	1,52 - 2,13 m
Soil Description	
Silt and sand, traces of gravel	

Prepared by Benoit St-Pierre, tech. **Approved by** Ibrahim Ja'far, ing. **Date** 2010-05-04

CLIENT TransAlta **N/D** G1-10-1532
PROJECT Geotechnical study - Wind energy converters (WEC)
LOCATION St-Valentin (Québec) **NO. LAB.** 36930

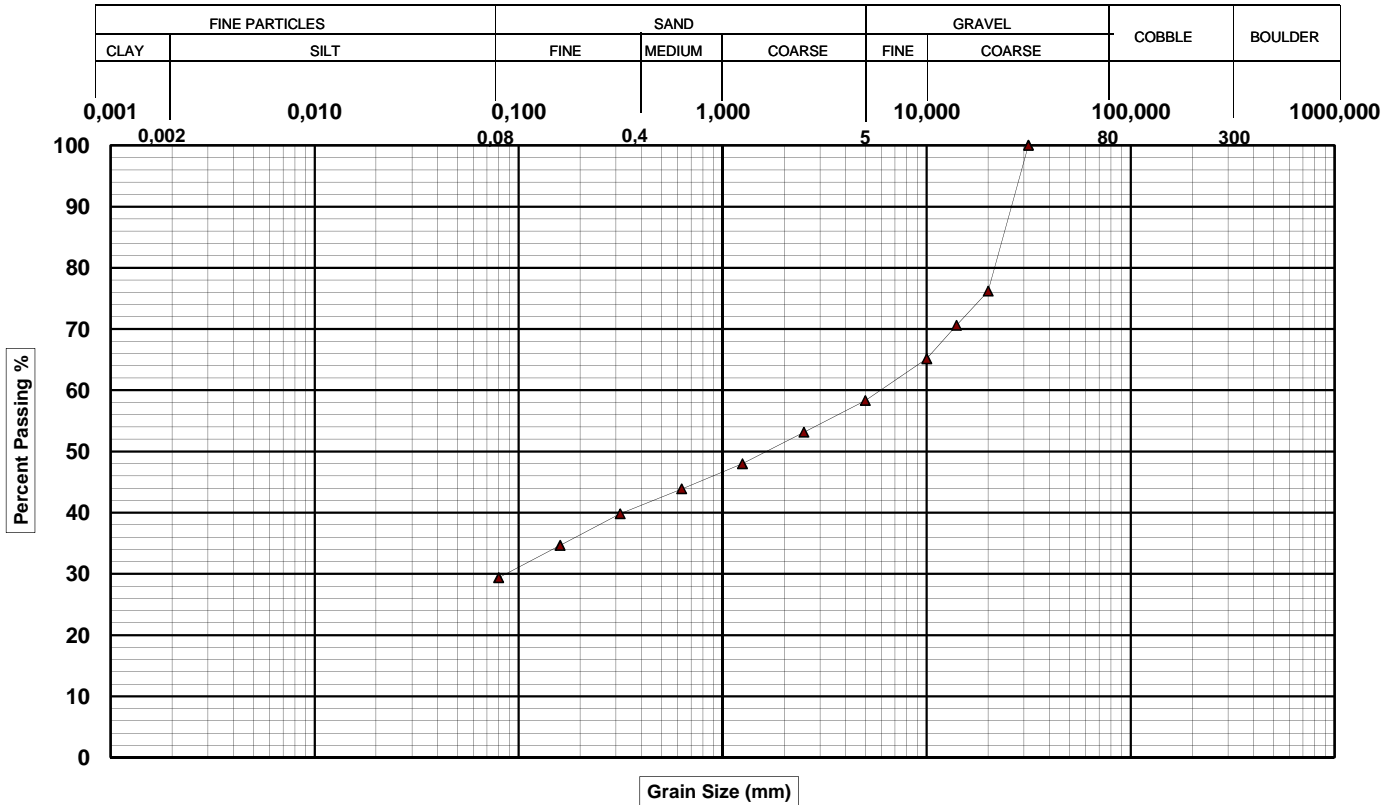

GRAIN-SIZE DISTRIBUTION

Fine Particles		Coarse Particles			
Clay (%)	Silt (%)	Sand (%)	Gravel (%)	Cobble (%)	Boulder (%)
-	29,4	28,9	41,7	0,0	0,0

D ₁₀ (mm)	D ₃₀ (mm)	D ₆₀ (mm)	C _u	C _c	W _n (%)
N/A	0,09	6,00	N/A	N/A	7

PERCENT PASSING

(mm)	(%)	(mm)	(%)	(mm)	(%)
80,00	100	2,500	53		
56,00	100	1,250	48		
40,00	100	0,630	44		
31,50	100	0,315	40		
20,00	76	0,160	35		
14,00	71	0,080	29,4		
10,00	65				
5,00	58				

SAMBLE IDENTIFICATION

Sample	10BH-37 (SS-07)
Depth	5,18 - 5,79 m
Soil Description	
Sandy silty gravel	

Prepared by Benoit St-Pierre, tech.

Approved by Ibrahim Ja'far, ing.

Date 2010-05-04

CLIENT	TransAlta	N/D G1-09-1532
PROJECT	Geotechnical study - Wind energy converters (WEC)	
LOCATION	St-Valentin	NO. LAB. 36671

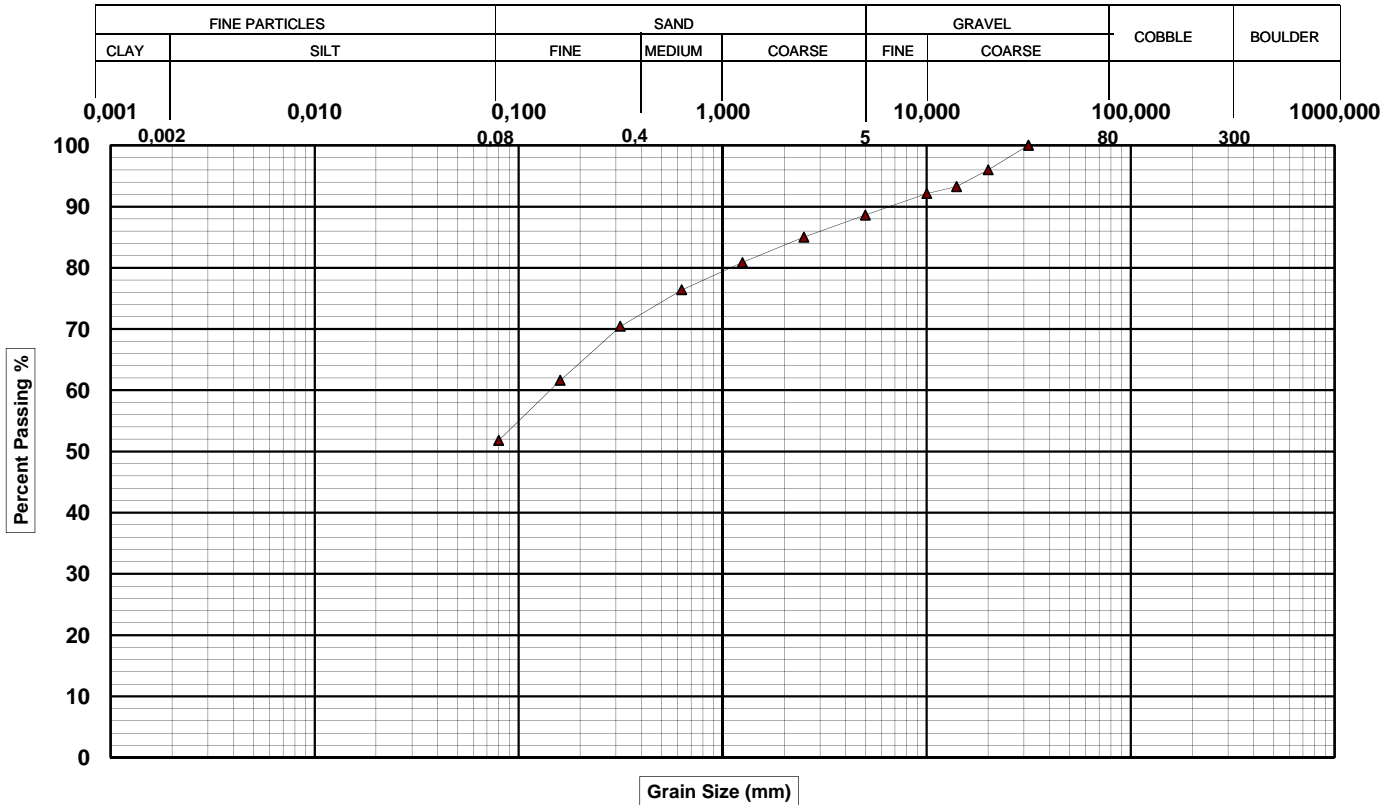

GRAIN-SIZE DISTRIBUTION					
Fine Particles			Coarse Particles		
Clay (%)	Silt (%)	Sand (%)	Gravel (%)	Cobble (%)	Boulder (%)
0,0	51,8	36,8	11,4	0,0	0,0

D₁₀ (mm)	D₃₀ (mm)	D₆₀ (mm)	C_u	C_c	W_n (%)
N/A	N/A	0,15	N/A	N/A	10

PERCENT PASSING					
(mm)	(%)	(mm)	(%)	(mm)	(%)
80,00	100	2,500	85		
56,00	100	1,250	81		
40,00	100	0,630	76		
31,50	100	0,315	70		
20,00	96	0,160	62		
14,00	93	0,080	51,8		
10,00	92				
5,00	89				

SAMBLE IDENTIFICATION	
Sample	10BH-35 (SS-02)
Depth	0,61 - 1,22 m
Soil Description	
Silt and sand, some gravel	

Prepared by Benoit St-Pierre	Approved by Ibrahim Ja'far, ing.	Date 2010-04-21
-------------------------------------	---	------------------------

CLIENT TransAlta **N/D** G1-09-1532
PROJECT Geotechnical study - Wind energy converters (WEC)
LOCATION St-Valentin **NO. LAB.** 36772

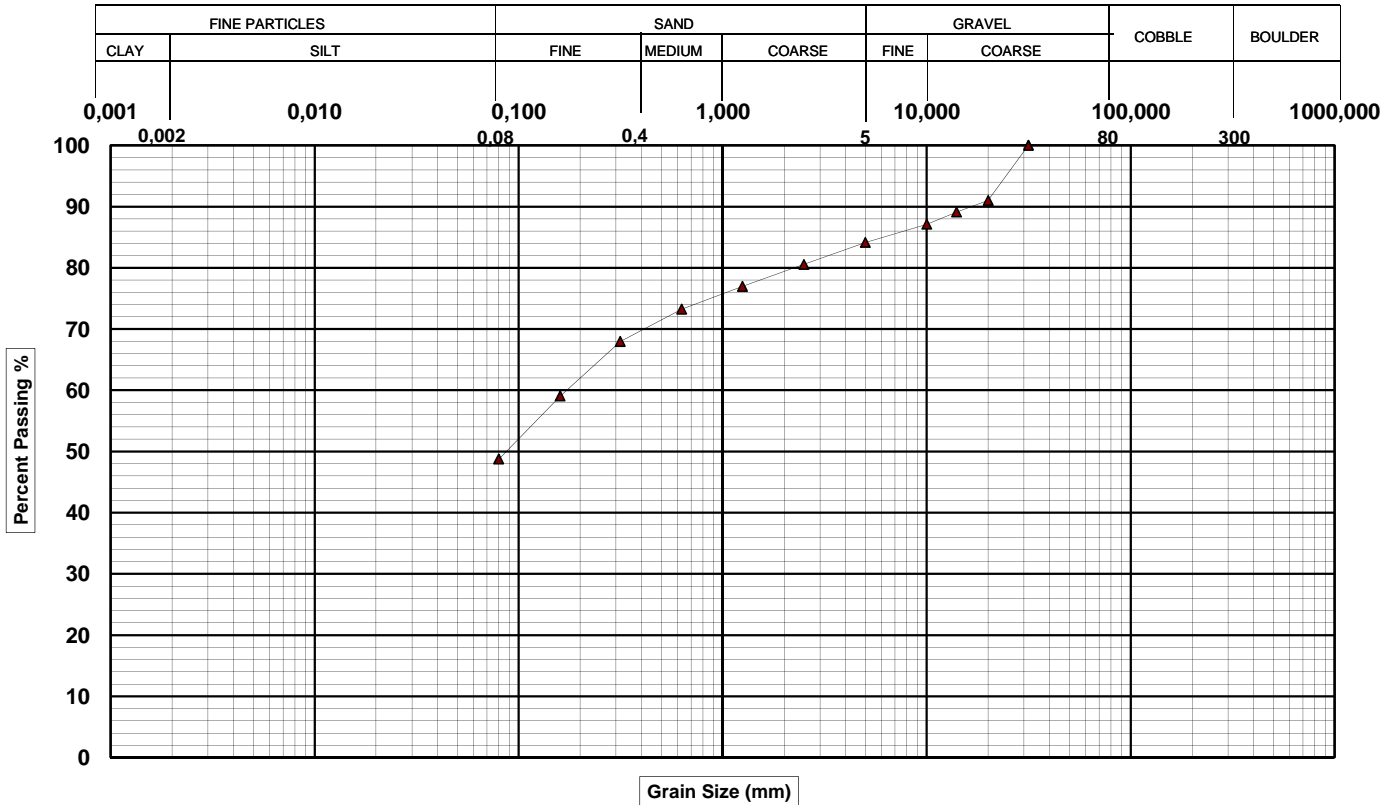

GRAIN-SIZE DISTRIBUTION					
Fine Particles		Coarse Particles			
Clay (%)	Silt (%)	Sand (%)	Gravel (%)	Cobble (%)	Boulder (%)
-	48,8	35,4	15,9	0,0	0,0

D ₁₀ (mm)	D ₃₀ (mm)	D ₆₀ (mm)	C _u	C _c	W _n (%)
N/A	N/A	0,19	N/A	N/A	8

PERCENT PASSING					
(mm)	(%)	(mm)	(%)	(mm)	(%)
80,00	100	2,500	81		
56,00	100	1,250	77		
40,00	100	0,630	73		
31,50	100	0,315	68		
20,00	91	0,160	59		
14,00	89	0,080	48,8		
10,00	87				
5,00	84				

SAMBLE IDENTIFICATION	
Sample	10BH-35 (SS-04)
Depth	2,44 - 3,05 m
Soil Description	
Sand and silt, a little gravel	

Prepared by Benoit St-Pierre **Approved by** Ibrahim Ja'far, ing. **Date** 2010-04-21

CLIENT TransAlta **N/D** G1-09-1532
PROJECT Geotechnical study - Wind energy converters (WEC)
LOCATION St-Valentin **NO. LAB.** 36674

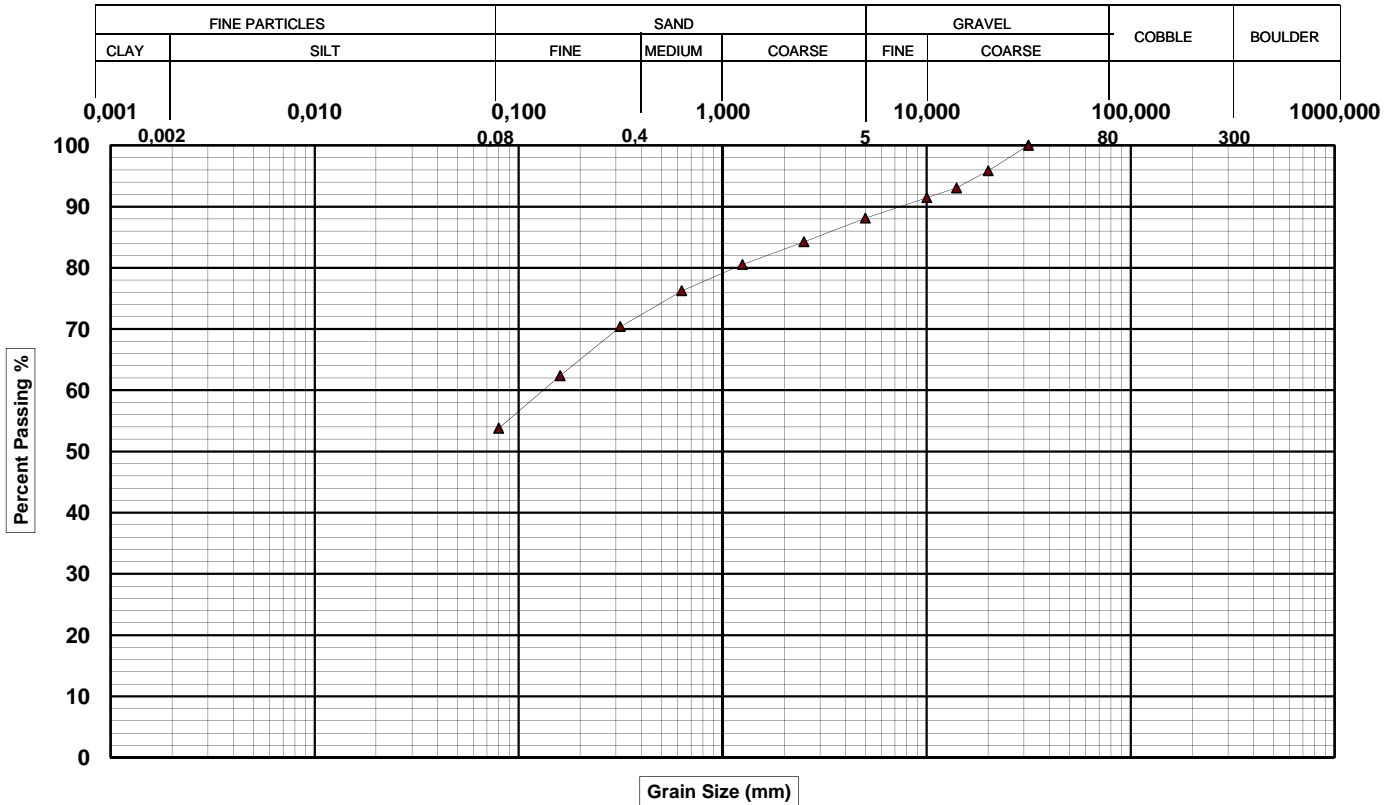

GRAIN-SIZE DISTRIBUTION					
Fine Particles			Coarse Particles		
Clay (%)	Silt (%)	Sand (%)	Gravel (%)	Cobble (%)	Boulder (%)
-	53,8	34,3	11,9	0,0	0,0

D ₁₀ (mm)	D ₃₀ (mm)	D ₆₀ (mm)	C _u	C _c	W _n (%)
N/A	N/A	0,14	N/A	N/A	12

PERCENT PASSING					
(mm)	(%)	(mm)	(%)	(mm)	(%)
80,00	100	2,500	84		
56,00	100	1,250	81		
40,00	100	0,630	76		
31,50	100	0,315	70		
20,00	96	0,160	62		
14,00	93	0,080	53,8		
10,00	91				
5,00	88				

SAMBLE IDENTIFICATION	
Sample	10BH-34 (SS-02)
Depth	0,61 - 1,22 m
Soil Description	
Silt and sand, some gravel	

Prepared by Benoit St-Pierre **Approved by** Ibrahim Ja'far, ing. **Date** 2010-04-21

CLIENT TransAlta **N/D** G1-09-1532
PROJECT Geotechnical study - Wind energy converters (WEC)
LOCATION St-Valentin **NO. LAB.** 36675

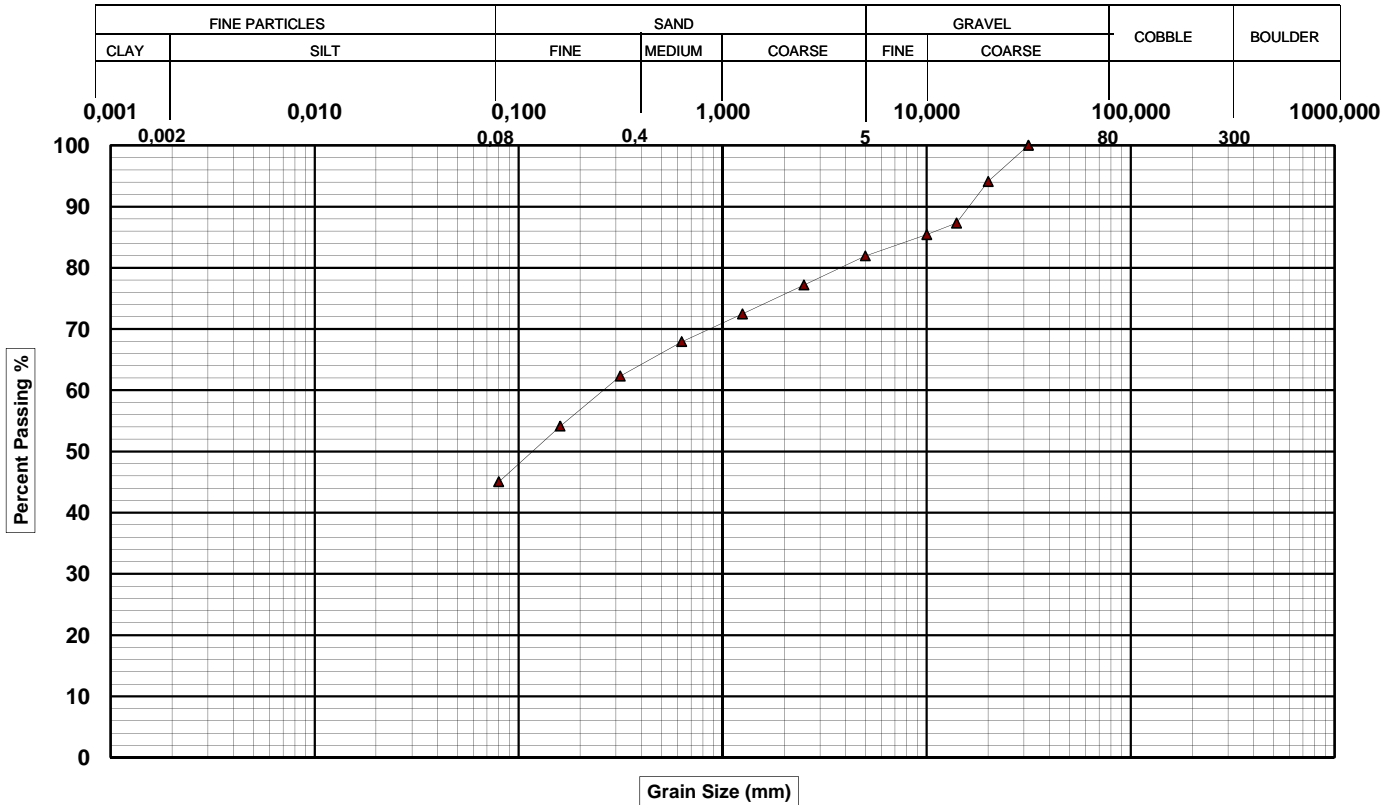

GRAIN-SIZE DISTRIBUTION					
Fine Particles		Coarse Particles			
Clay (%)	Silt (%)	Sand (%)	Gravel (%)	Cobble (%)	Boulder (%)
-	45,0	36,9	18,1	0,0	0,0

D₁₀ (mm)	D₃₀ (mm)	D₆₀ (mm)	C_u	C_c	W_n (%)
N/A	N/A	0,28	N/A	N/A	9

PERCENT PASSING					
(mm)	(%)	(mm)	(%)	(mm)	(%)
80,00	100	2,500	77		
56,00	100	1,250	72		
40,00	100	0,630	68		
31,50	100	0,315	62		
20,00	94	0,160	54		
14,00	87	0,080	45,0		
10,00	85				
5,00	82				

SAMBLE IDENTIFICATION	
Sample	10BH-34 (SS-04)
Depth	2,44 - 3,05 m
Soil Description	
Silt and sand, some gravel	

Prepared by Benoit St-Pierre **Approved by** Ibrahim Ja'far, ing. **Date** 2010-04-21

CLIENT TransAlta **N/D** G1-09-1532
PROJECT Geotechnical study - Wind energy converters (WEC)
LOCATION St-Valentin (Québec) **NO. LAB.** 36604

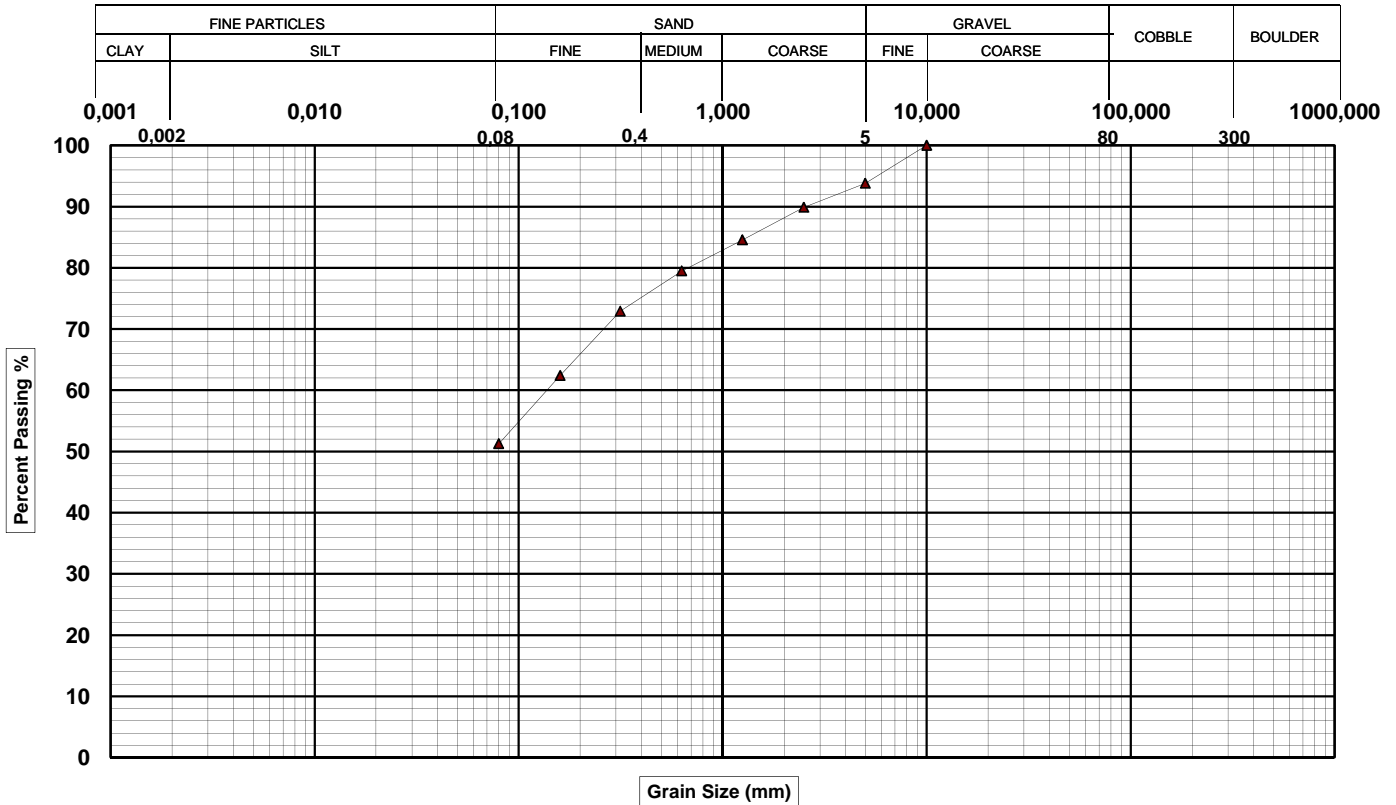

GRAIN-SIZE DISTRIBUTION

Fine Particles		Coarse Particles			
Clay (%)	Silt (%)	Sand (%)	Gravel (%)	Cobble (%)	Boulder (%)
-	51,3	42,5	6,2	0,0	0,0

D ₁₀ (mm)	D ₃₀ (mm)	D ₆₀ (mm)	C _u	C _c	W _n (%)
N/A	N/A	0,14	N/A	N/A	14

PERCENT PASSING					
(mm)	(%)	(mm)	(%)	(mm)	(%)
80,00	100	2,500	90		
56,00	100	1,250	85		
40,00	100	0,630	79		
31,50	100	0,315	73		
20,00	100	0,160	62		
14,00	100	0,080	51,3		
10,00	100				
5,00	94				

SAMBLE IDENTIFICATION	
Sample	10BH-21 (SS-05)
Depth	3,35 - 3,96 m
Soil Description	
Silt and sand, traces of gravel	

Prepared by Benoit St-Pierre **Approved by** Ibrahim Ja'far, ing. **Date** 2010-04-22

CLIENT	TransAlta	N/D G1-09-1532
PROJECT	Geotechnical study - Wind energy converters (WEC)	
LOCATION	St-Valentin (Québec)	NO. LAB. 36607

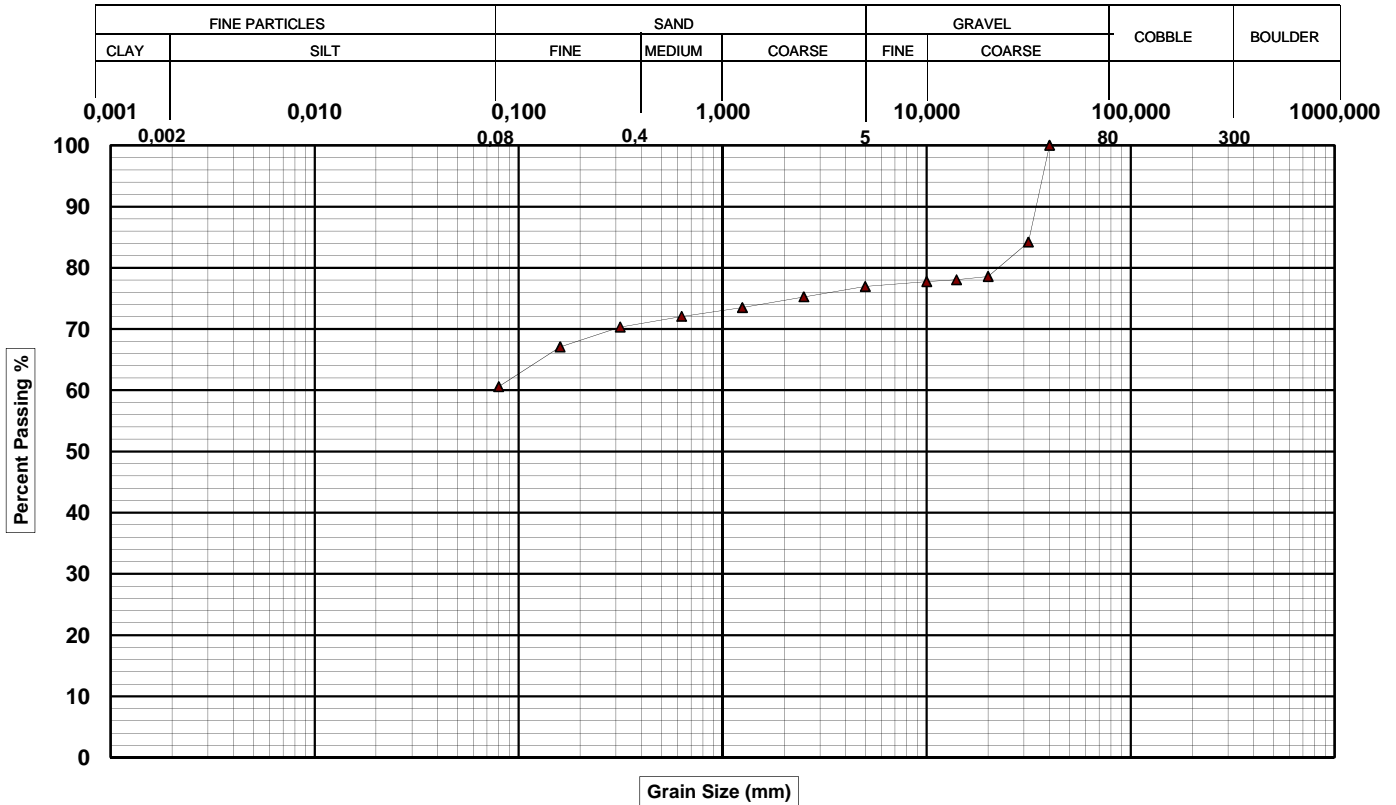

GRAIN-SIZE DISTRIBUTION					
Fine Particles		Coarse Particles			
Clay (%)	Silt (%)	Sand (%)	Gravel (%)	Cobble (%)	Boulder (%)
-	60,6	16,3	23,0	0,0	0,0

D ₁₀ (mm)	D ₃₀ (mm)	D ₆₀ (mm)	C _u	C _c	W _n (%)
N/A	N/A	N/A	N/A	N/A	10

PERCENT PASSING					
(mm)	(%)	(mm)	(%)	(mm)	(%)
80,00	100	2,500	75		
56,00	100	1,250	73		
40,00	100	0,630	72		
31,50	84	0,315	70		
20,00	79	0,160	67		
14,00	78	0,080	60,6		
10,00	78				
5,00	77				

SAMBLE IDENTIFICATION	
Sample	10BH-21 (SS-11)
Depth	9,14 - 9,75 m
Soil Description	
Gravelly silt, some sand	

Prepared by Benoit St-Pierre	Approved by Ibrahim Ja'far, ing.	Date 2010-04-22
-------------------------------------	---	------------------------

CLIENT	TransAlta	N/D G1-09-1532
PROJECT	Geotechnical study - Wind energy converters (WEC)	
LOCATION	St-Valentin (Québec)	NO. LAB. 36601

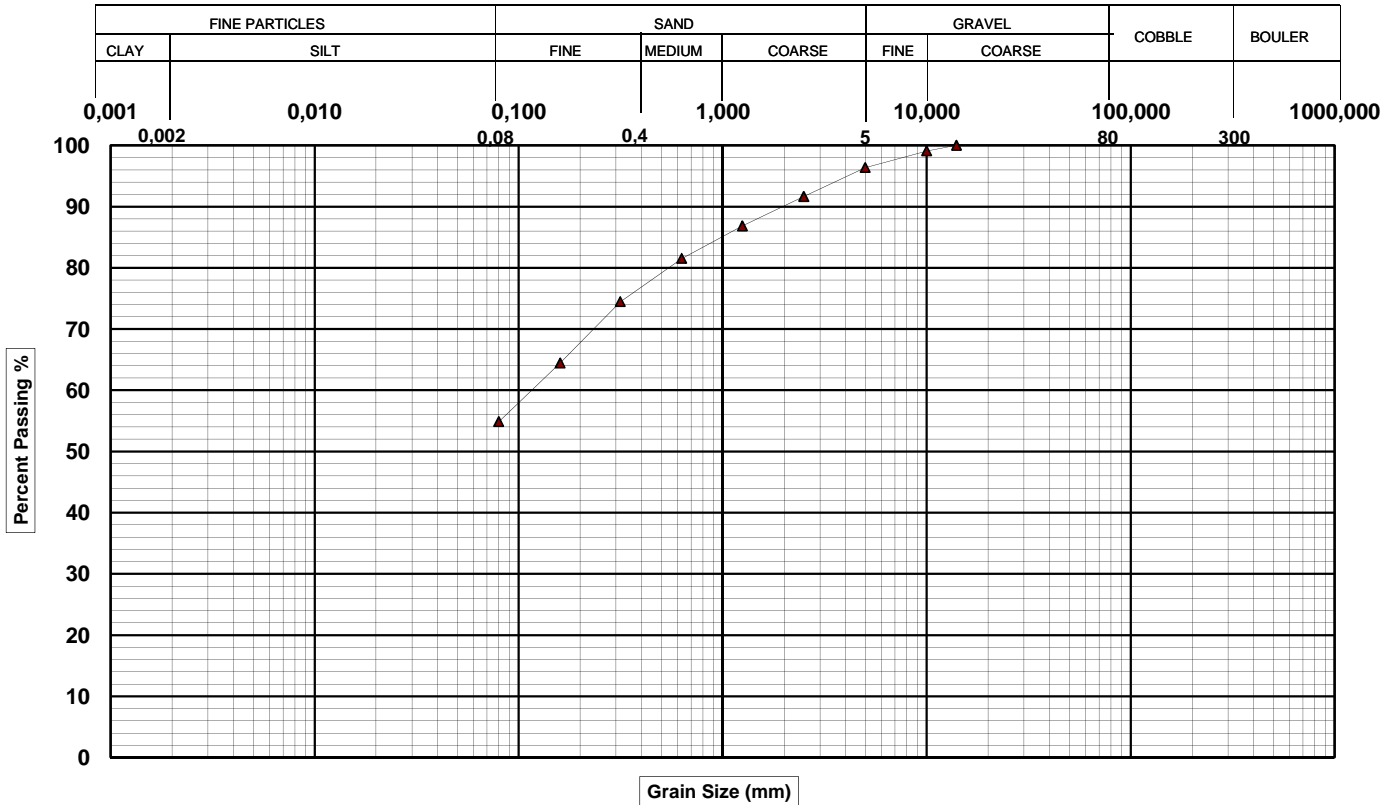

GRAIN-SIZE DISTRIBUTION					
Fine Particles		Coarse Particles			
Clay (%)	Silt (%)	Sand (%)	Gravel (%)	Cobble (%)	Boulder (%)
-	54,9	41,5	3,6	0,0	0,0

D₁₀ (mm)	D₃₀ (mm)	D₆₀ (mm)	C_u	C_c	W_n (%)
N/A	N/A	0,12	N/A	N/A	12

PERCENT PASSING					
(mm)	(%)	(mm)	(%)	(mm)	(%)
80,00	100	2,500	92		
56,00	100	1,250	87		
40,00	100	0,630	82		
31,50	100	0,315	74		
20,00	100	0,160	64		
14,00	100	0,080	54,9		
10,00	99				
5,00	96				

SAMBLE IDENTIFICATION	
Sample	10BH-20 (SS-04)
Depth	2,44 - 3,05 m
Soil Description	
Silt and sand, traces of gravel	

Prepared by Benoit St-Pierre **Approved by** Ibrahim Ja'far, ing. **Date** 2010-04-22

CLIENT TransAlta **N/D** G1-09-1532
PROJECT Geotechnical study - Wind energy converters (WEC)
LOCATION St-Valentin (Québec) **NO. LAB.** 36602

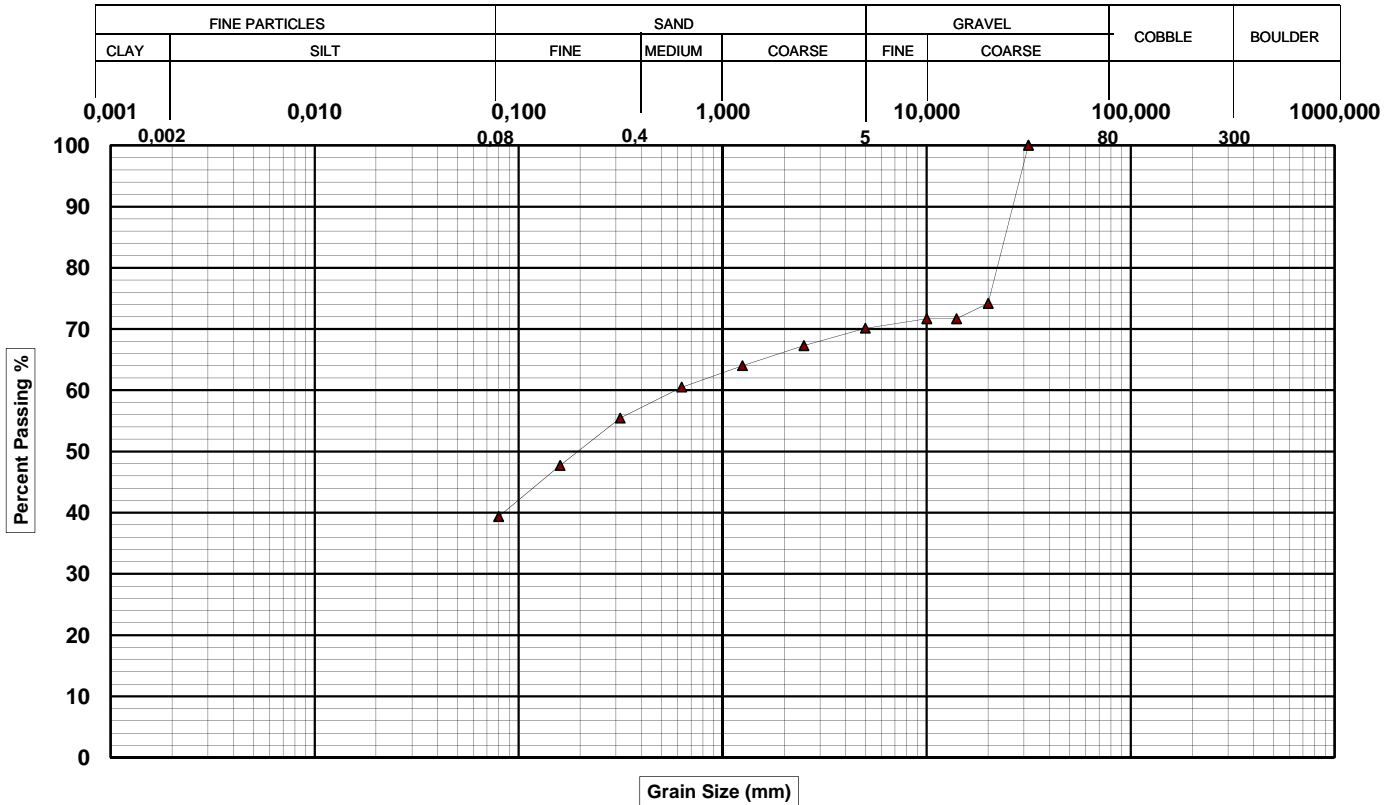

GRAIN-SIZE DISTRIBUTION					
Fine Particles		Coarse Particles			
Clay (%)	Silt (%)	Sand (%)	Gravel (%)	Cobble (%)	Boulder (%)
-	39,4	30,8	29,9	0,0	0,0

D₁₀ (mm)	D₃₀ (mm)	D₆₀ (mm)	C_u	C_c	W_n (%)
N/A	N/A	0,60	N/A	N/A	7

PERCENT PASSING					
(mm)	(%)	(mm)	(%)	(mm)	(%)
80,00	100	2,500	67		
56,00	100	1,250	64		
40,00	100	0,630	61		
31,50	100	0,315	55		
20,00	74	0,160	48		
14,00	72	0,080	39,4		
10,00	72				
5,00	70				

SAMBLE IDENTIFICATION	
Sample	10BH-20 (SS-07)
Depth	5,18 - 5,79 m
Soil Description	
Gravelly sandy silt	

Prepared by Benoit St-Pierre **Approved by** Ibrahim Ja'far, ing. **Date** 2010-04-22

CLIENT	TransAlta	N/D G1-09-1532
PROJECT	Geotechnical study - Wind energy converters (WEC)	
LOCATION	St-Valentin (Québec)	NO. LAB. 36603

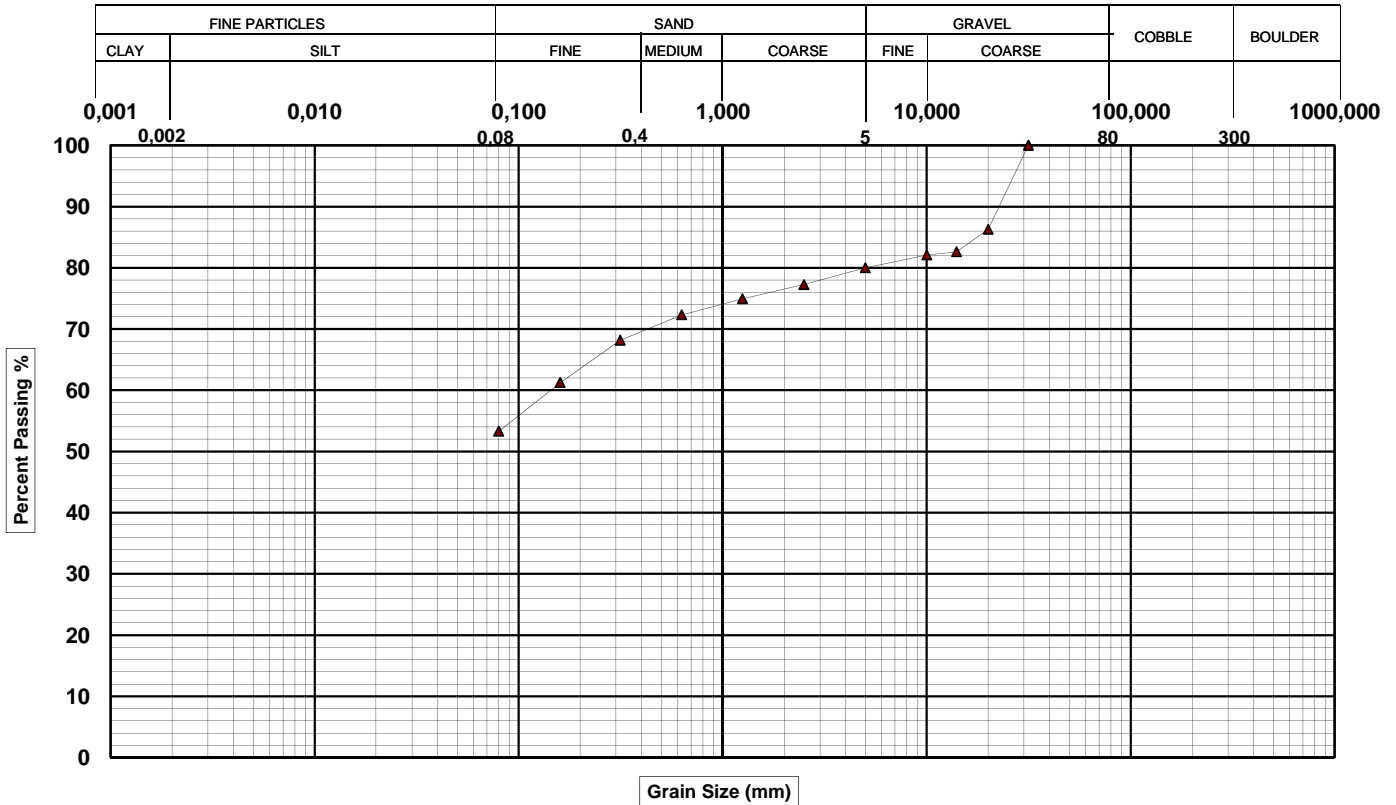

GRAIN-SIZE DISTRIBUTION					
Fine Particles		Coarse Particles			
Clay (%)	Silt (%)	Sand (%)	Gravel (%)	Cobble (%)	Boulder (%)
-	53,3	26,7	20,0	0,0	0,0

D ₁₀ (mm)	D ₃₀ (mm)	D ₆₀ (mm)	C _u	C _c	W _n (%)
N/A	N/A	0,15	N/A	N/A	15

PERCENT PASSING					
(mm)	(%)	(mm)	(%)	(mm)	(%)
80,00	100	2,500	77		
56,00	100	1,250	75		
40,00	100	0,630	72		
31,50	100	0,315	68		
20,00	86	0,160	61		
14,00	83	0,080	53,3		
10,00	82				
5,00	80				

SAMBLE IDENTIFICATION	
Sample	10BH-20 (SS-10)
Depth	7,92 - 8,53 m
Soil Description	
Sandy silt, some gravel	

Prepared by Benoit St-pierre	Approved by Ibrahim Ja'far, ing.	Date 2010-04-22
-------------------------------------	---	------------------------

CLIENT TransAlta **N/D** G1-09-1532
PROJECT Geotechnical study - Wind energy converters (WEC)
LOCATION St-Valentin (Québec) **NO. LAB.** 36605

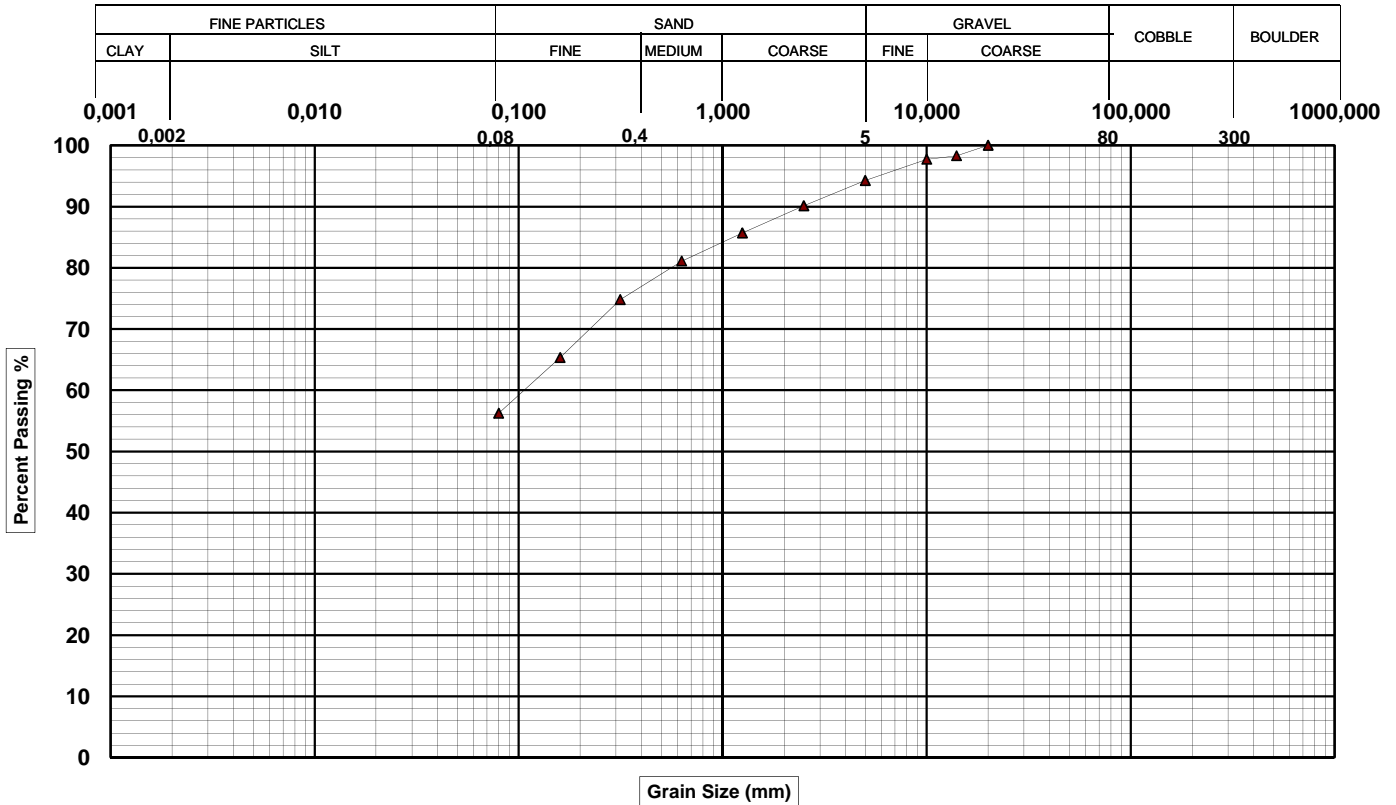

GRAIN-SIZE DISTRIBUTION					
Fine Particles		Coarse Particles			
Clay (%)	Silt (%)	Sand (%)	Gravel (%)	Cobble (%)	Boulder (%)
-	56,2	38,0	5,8	0,0	0,0

D₁₀ (mm)	D₃₀ (mm)	D₆₀ (mm)	C_u	C_c	W_n (%)
N/A	N/A	0,10	N/A	N/A	11

PERCENT PASSING					
(mm)	(%)	(mm)	(%)	(mm)	(%)
80,00	100	2,500	90		
56,00	100	1,250	86		
40,00	100	0,630	81		
31,50	100	0,315	75		
20,00	100	0,160	65		
14,00	98	0,080	56,2		
10,00	98				
5,00	94				

SAMBLE IDENTIFICATION	
Sample	10BH-21 (SS-07)
Depth	5,18 - 5,79 m
Soil Description	
Silt and sand, traces of gravel	

Prepared by Benoit St-pierre **Approved by** Ibrahim Ja'far, ing. **Date** 2010-04-22

CLIENT TranAlta **N/D**G1-10-1532
PROJCT Geotechnical study - Wind energy converters (WEC)
LOCATION St-Valentin **NO. LAB.** G1-09-15

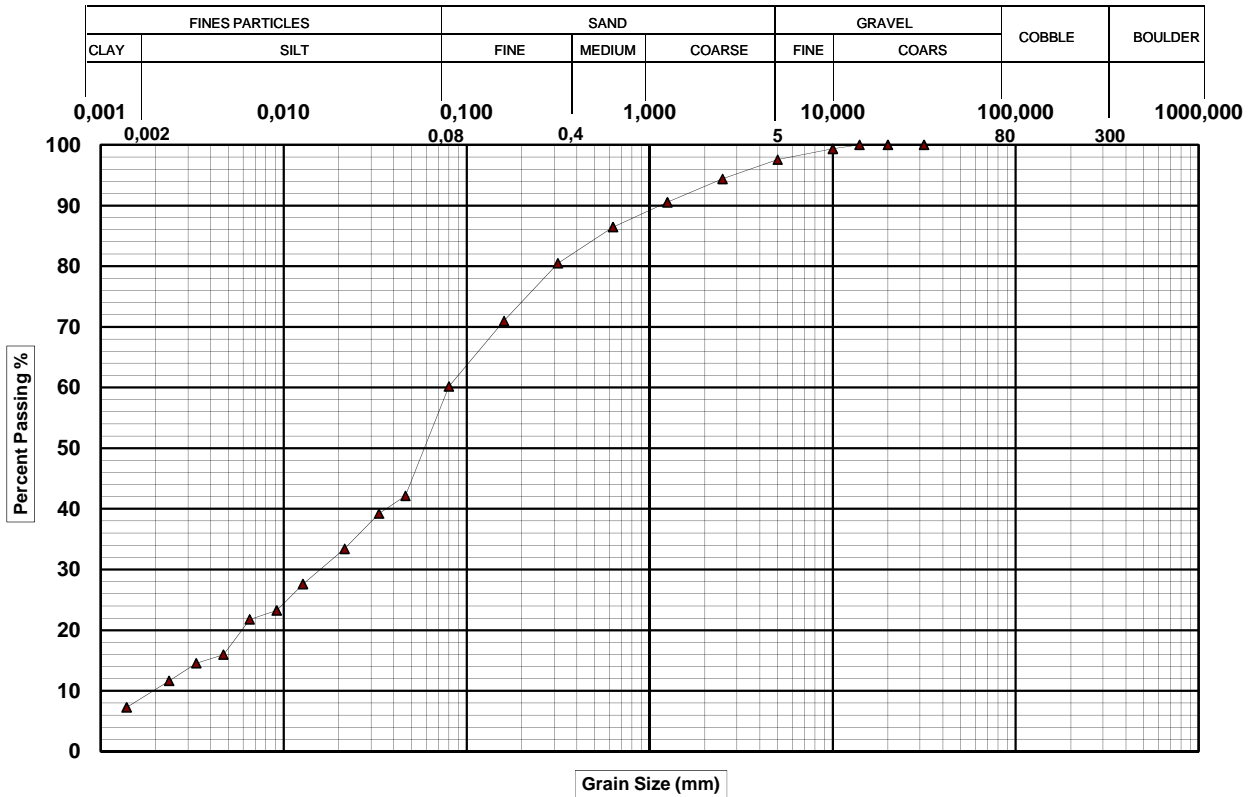

CLIENT TransAlta **N/D** G1-09-1532
PROJECT Geotechnical study - Wind energy converters (WEC)
LOCATION St-Valentin (Québec) **NO. LAB.** 36713

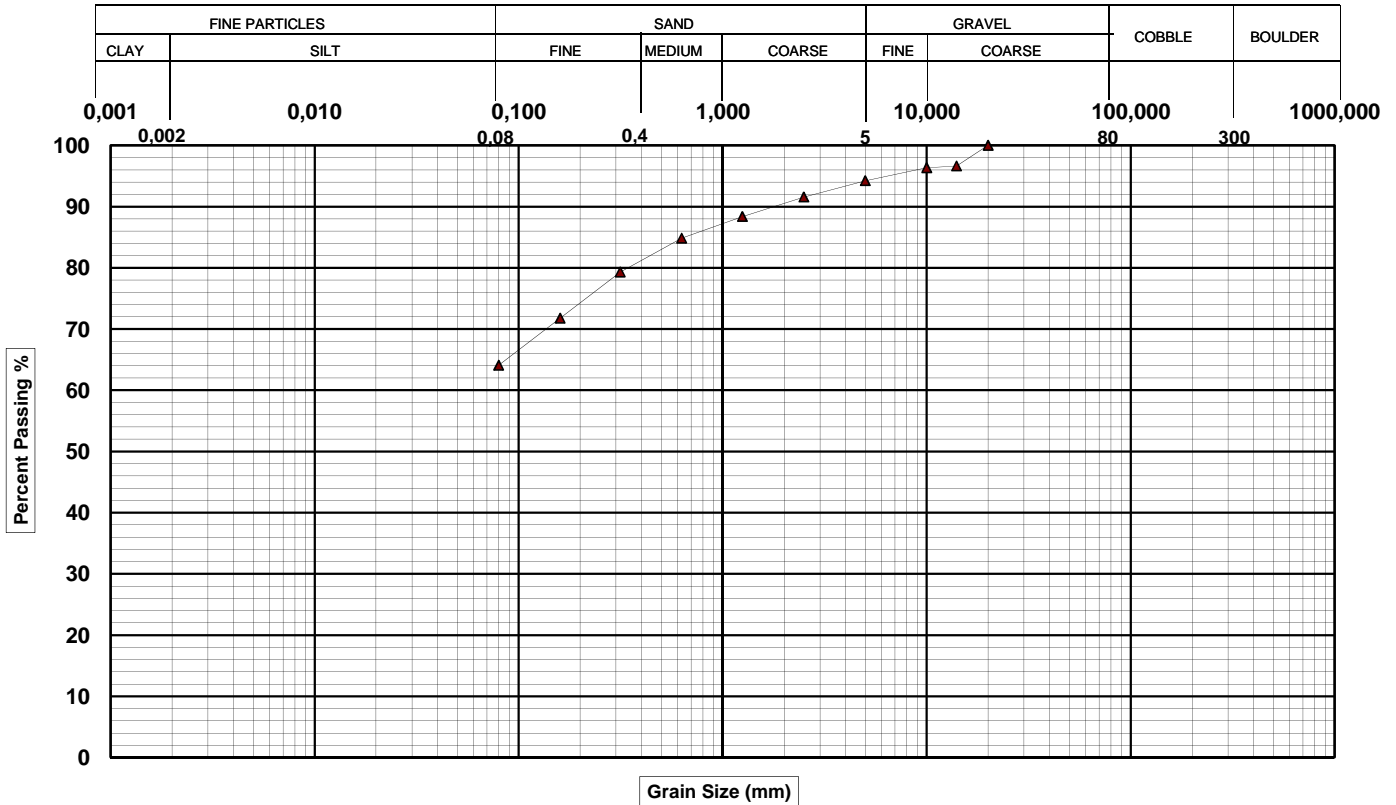

GRAIN-SIZE DISTRIBUTION					
Fine Particles		Coarse Particles			
Clay (%)	Silt (%)	Sand (%)	Gravel (%)	Cobble (%)	Boulder (%)
-	64,1	30,1	5,8	0,0	0,0

D ₁₀ (mm)	D ₃₀ (mm)	D ₆₀ (mm)	C _u	C _c	W _n (%)
N/A	N/A	N/A	N/A	N/A	13

PERCENT PASSING					
(mm)	(%)	(mm)	(%)	(mm)	(%)
80,00	100	2,500	92		
56,00	100	1,250	88		
40,00	100	0,630	85		
31,50	100	0,315	79		
20,00	100	0,160	72		
14,00	97	0,080	64,1		
10,00	96				
5,00	94				

SAMBLE IDENTIFICATION	
Sample	10BH-23 (SS-02)
Depth	0,61 - 1,22 m
Soil Description	
Sandy silt, traces of gravel	

Prepared by Benoit St-pierre **Approved by** Ibrahim Ja'far, ing. **Date** 2010-04-22

CLIENT TransAlta **N/D** G1-09-1532
PROJECT Geotechnical study - Wind energy converters (WEC)
LOCATION St-Valentin (Québec) **NO. LAB.** 36714

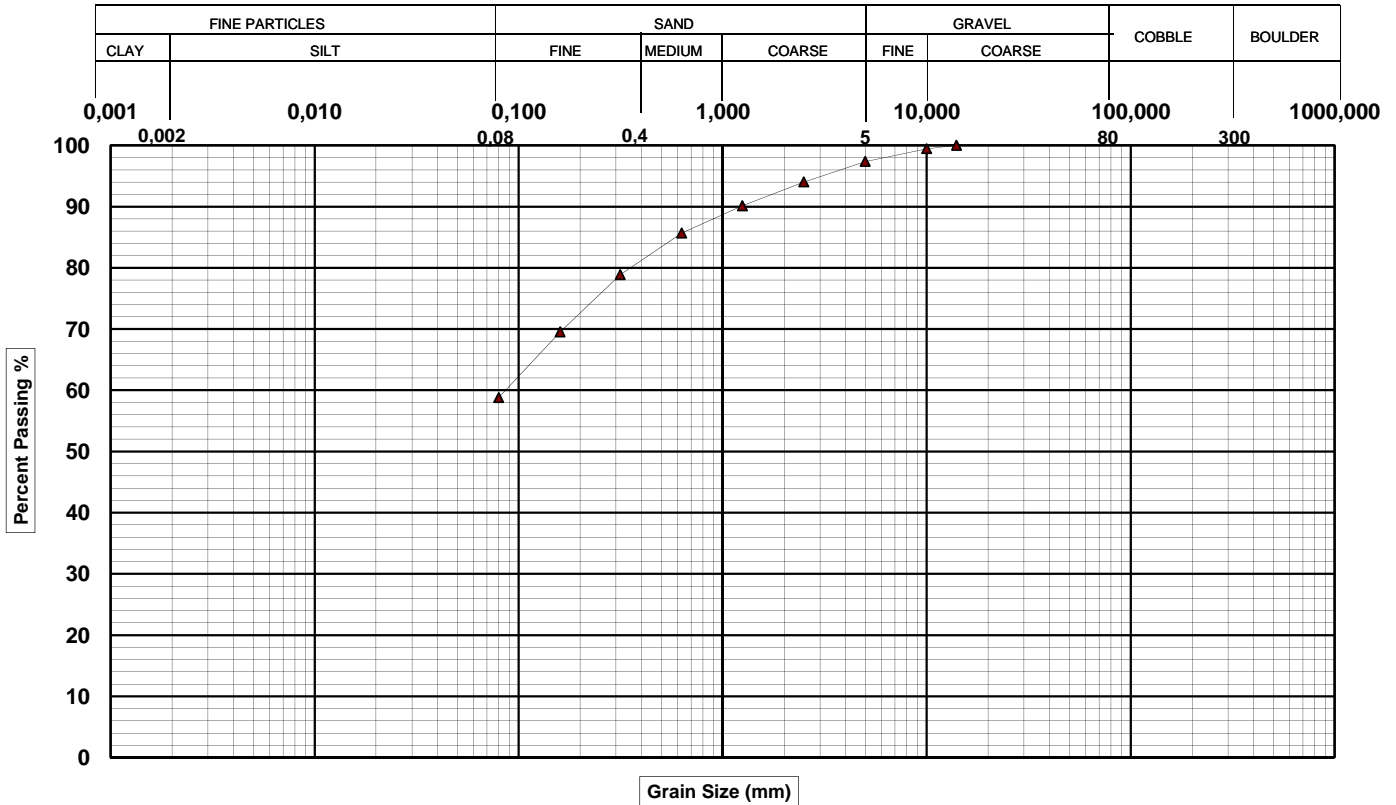

GRAIN-SIZE DISTRIBUTION					
Fine Particles		Coarse Particles			
Clay (%)	Silt (%)	Sand (%)	Gravel (%)	Cobble (%)	Boulder (%)
-	58,8	38,5	2,6	0,0	0,0

D₁₀ (mm)	D₃₀ (mm)	D₆₀ (mm)	C_u	C_c	W_n (%)
N/A	N/A	0,09	N/A	N/A	12

PERCENT PASSING					
(mm)	(%)	(mm)	(%)	(mm)	(%)
80,00	100	2,500	94		
56,00	100	1,250	90		
40,00	100	0,630	86		
31,50	100	0,315	79		
20,00	100	0,160	70		
14,00	100	0,080	58,8		
10,00	99				
5,00	97				

SAMBLE IDENTIFICATION	
Sample	10BH-23 (SS-05)
Depth	3,35 - 3,96 m
Soil Description	
Silt and sand, traces of gravel	

Prepared by Benoit St-pierre **Approved by** Ibrahim Ja'far, ing. **Date** 2010-04-22

CLIENT TransAlta **N/D** G1-09-1532
PROJECT Geotechnical study - Wind energy converters (WEC)
LOCATION St-Valentin (Québec) **NO. LAB.** 36715

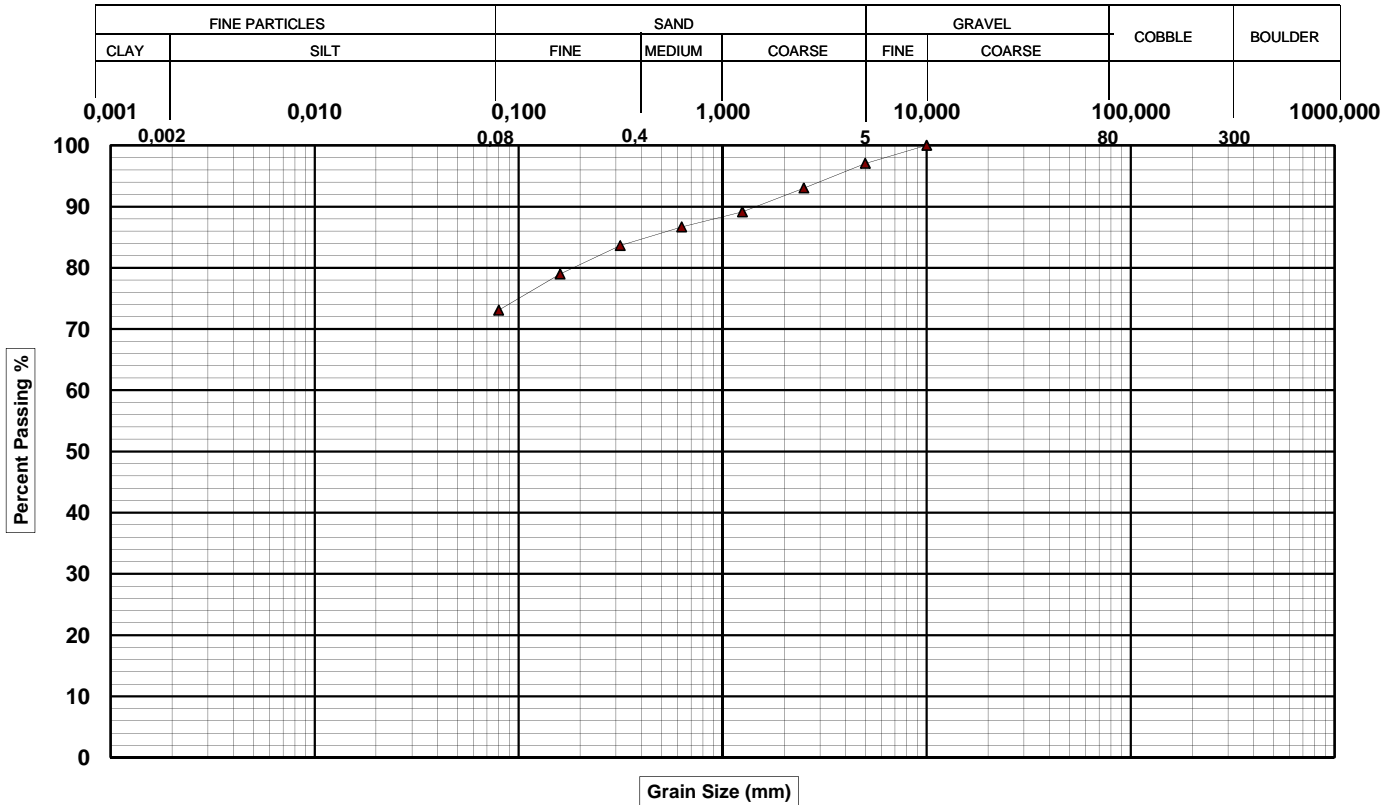

GRAIN-SIZE DISTRIBUTION					
Fine Particles		Coarse Particles			
Clay (%)	Silt (%)	Sand (%)	Gravel (%)	Cobble (%)	Boulder (%)
-	73,1	24,0	2,9	0,0	0,0

D ₁₀ (mm)	D ₃₀ (mm)	D ₆₀ (mm)	C _u	C _c	W _n (%)
N/A	N/A	N/A	N/A	N/A	14

PERCENT PASSING					
(mm)	(%)	(mm)	(%)	(mm)	(%)
80,00	100	2,500	93		
56,00	100	1,250	89		
40,00	100	0,630	87		
31,50	100	0,315	84		
20,00	100	0,160	79		
14,00	100	0,080	73,1		
10,00	100				
5,00	97				

SAMBLE IDENTIFICATION	
Sample	10F-23 (CF-10)
Depth	9,14 - 9,75 m
Soil Description	
Sandy silt, traces of gravel	

Prepared by Benoit St-pierre **Approved by** Ibrahim Ja'far, ing. **Date** 2010-04-22

Appendix E

Geophysical investigation report

**SHEAR WAVE VELOCITY SOUNDING RESULTS – WIND ENERGY CONVERTERS
PROJECT, SAINT-VALENTIN, QUÉBEC**

Presented to :

GROUPE ABS INC.
17, rue de l'Industrie
St-Rémi-de-Napierville (Québec)
J0L 2L0

Presented by :

GEOPHYSICS GPR INTERNATIONAL INC.
100 – 2545, rue Delorimier
Longueuil (Québec)
J4K 3P7

JUNE 2010

M09789



TABLE OF CONTENTS

1.	INTRODUCTION	1
2.	SITE LOCATION	1
3.	METHODOLOGY	4
3.1	Basic theory	4
3.2	Survey design	5
3.3	Interpretation method	5
4.	RESULTS.....	8
5.	CONCLUSION.....	12

LIST OF FIGURES

FIGURE 1	Location of St. Valentin within the Montérégie region	2
FIGURE 2	MASW sounding locations	3
FIGURE 3	MASW operating principle.....	6
FIGURE 4	Example of a typical MASW shot record	7

LIST OF TABLES

TABLE 1	MASW sounding site coordinates.....	10
TABLE 2	Average velocities vs. geographical groups.....	11

LIST OF APPENDICES

APPENDIX A	MASW sounding results
------------	-----------------------



1. **INTRODUCTION**

Geophysics GPR International Inc. has been requested by Groupe ABS Inc. to carry out shear wave velocity soundings at 31 locations in the vicinity of the town of Saint-Valentin, Québec. This work is part of the geotechnical studies for a future wind farm. The geophysical investigations utilized the Multi-channel Analysis of Surface Waves (MASW) method to generate a shear wave velocity depth profile. The study aimed to obtain the average shear wave velocity for the first 30 metres of soil and rock.

The surveys were carried out between March 15 and 27, 2010 and on June 2nd, 2010.

2. **SITE LOCATION**

The town of Saint-Valentin is located about 60 km South-East of Montréal in the Montérégie administrative region. The soundings are located approximately within a 5 km radius from Saint-Valentin. Figure 1 shows a regional map of the Montérégie region. Figure 2 shows a local map with the position of each sounding site.

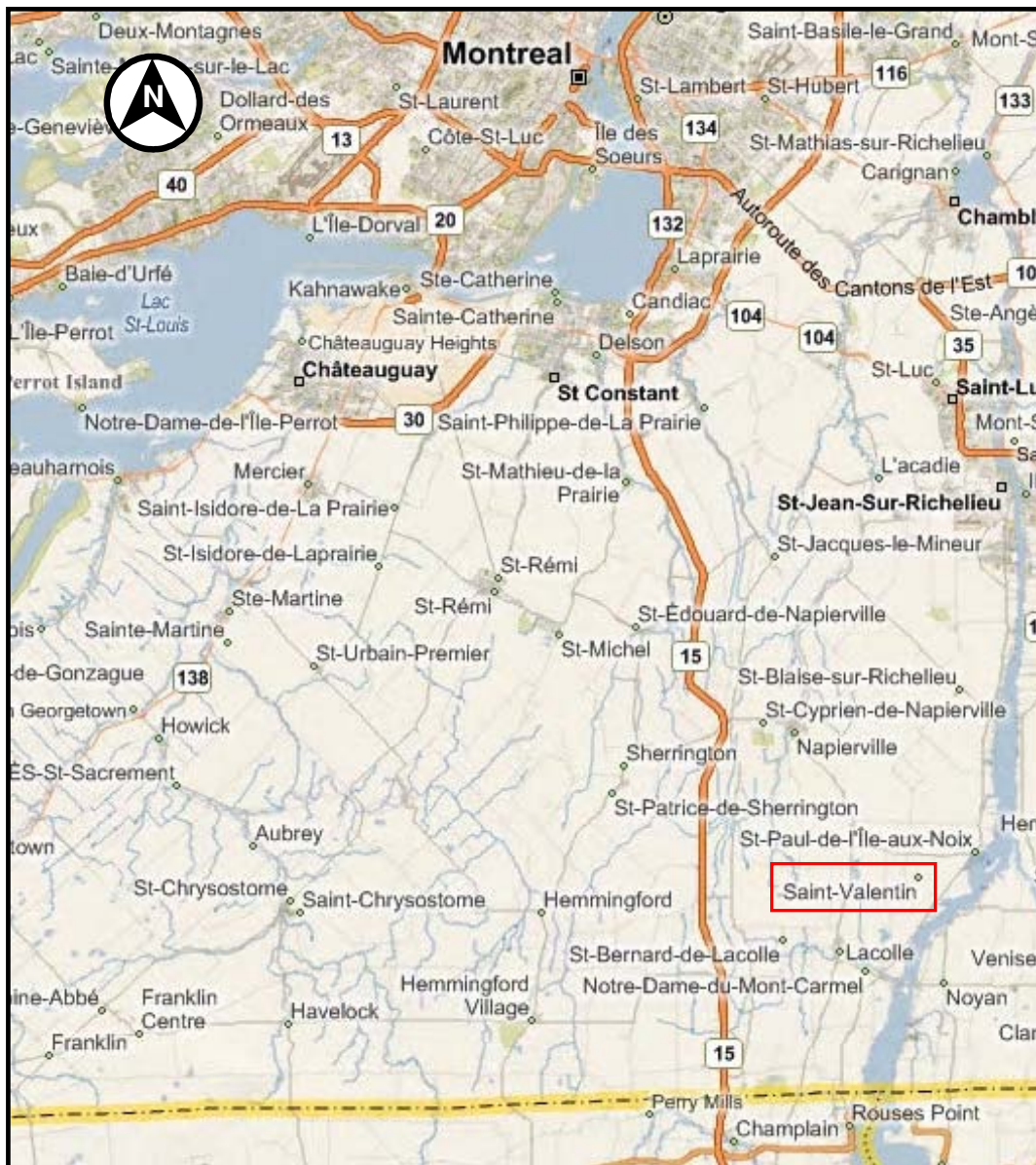
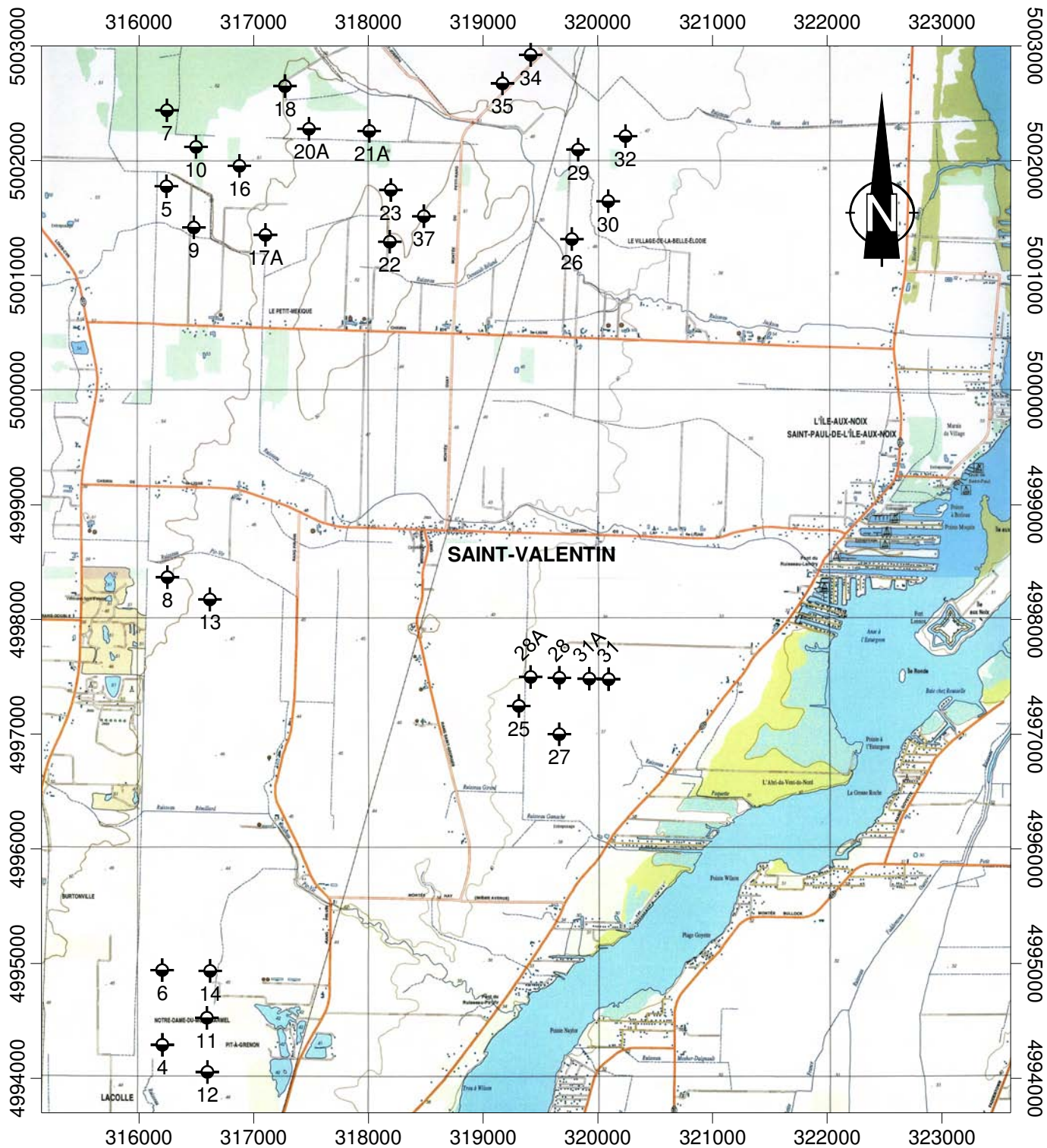

FIGURE 1

Location of Saint-Valentin within the Montérégie region (source: Bing Maps™)





Site coordinates provided by Groupe ABS

Scale 1 : 50 000
MTM NAD83 zone 8

FIGURE 2
MASW sounding locations



3. **METHODOLOGY**

3.1 **Basic Theory**

The Multi-channel Analysis of Surface Waves (MASW) and the Extended Spatial Autocorrelation Method (ESPAC) are seismic methods used to evaluate the shear wave velocities of subsurface materials through the analysis of the dispersion properties of Rayleigh surface waves (“ground roll”). The MASW is considered as an “active” method, as the seismic signal is induced at known location and time in the geophones spread axis. Conversely, the ESPAC is considered as a “passive” method, using the low frequency “noises” produced far away.

The dispersion properties are measured as a change in phase velocity with frequency. Surface wave energy will decay exponentially with depth. Lower frequency surface waves will travel deeper and thus be more influenced by deeper velocity layering than the shallow higher frequency waves. Inversion of the Rayleigh wave dispersion curve yields a shear wave (V_s) velocity depth profile (sounding). Figure 3 outlines the basic operating procedure for the MASW method. Figure 4 is an example image of a typical MASW record and resulting 1D V_s model.

The ESPAC method allows deeper V_s soundings, but with a poor resolution for the surface portion. Its dispersion curve can then be merged with the higher frequency curve from the MASW to allow a more complete inversion of the data. A detailed description of the MASW method can be found in the paper *Multi-channel Analysis of Surface Waves*, Park, C.B., Miller, R.D. and Xia, J. *Geophysics*, Vol. 64, No. 3 (May-June 1999); P. 800–808. For the SPAC method, one can refer to the paper *Shear Velocity Profiles Obtained from Microtremor Array Data with an Example from Direct Fitting of SPAC Curves*, Asten, M.W., 2007, Proceedings of the 20th SAGEEP Conference, Denver, Environmental and Engineering Geophysical Society.



3.2 Survey Design

The MASW survey utilizes a similar set-up to a seismic refraction investigation (i.e. 24 geophones in a linear array). The principle consists of intentionally generating a seismic wave at the surface and digitally recording the surface waves from the moment of source impact with a linear series of geophones on the surface.

A 12 pound sledgehammer was used as the primary energy source with traces being recorded off both ends of the seismic spread (4 shots per spread). Two geophone spacing values (1m and 3m) were used in order to get good resolution of surface velocities as well as good depth penetration. The total spread length was 23 m for the 1 m spacing and 69m for the 3m spacing. Unlike the refraction method, which produces a data point beneath each geophone, the shear wave depth profile is the average of the bulk area within the geophone spread, especially for its central half-length.

The orientation of the MASW spreads was determined on-site, depending on site access and clearance available.

3.3 Interpretation Method

The main processing sequence involved plotting, picking and 1D inversion of the MASW shot records using the SeisImagerSW™ software package. In theory, all the MASW shot records for a given spread should produce a similar shear wave velocity profile. In practice, however, differences can arise due to energy dissipation, localized surface variations, and/or dipping of overburden layers or rock. In general, the precision of the calculated seismic shear wave velocities (V_s) is of the order of 15% or better. When the penetration of the MASW shots was not sufficient, the same data points were processed using the ESPAC method to obtain greater depth penetration.



The results of the MASW tests are normally presented in chart format. It presents the 1-D shear wave velocity values from the inversion models of dispersion curves of the active MASW.

The V_{S30} value is based on the harmonic mean of the shear wave velocities, from the surface to a depth of 30 metres. The V_{S30} value is calculated by dividing the total depth of interest (e.g. 30m) by the sum of the time spent in each velocity layer from the surface up to that depth. This harmonic mean value reflects an equivalent single layer response.

The V_{S30} is used to determine the Site Classification for Seismic Site Response, as presented in the National Building Code of Canada (NBCC, 2005 ed.), as specified in table 4.1.8.4.A of the mentioned document¹.

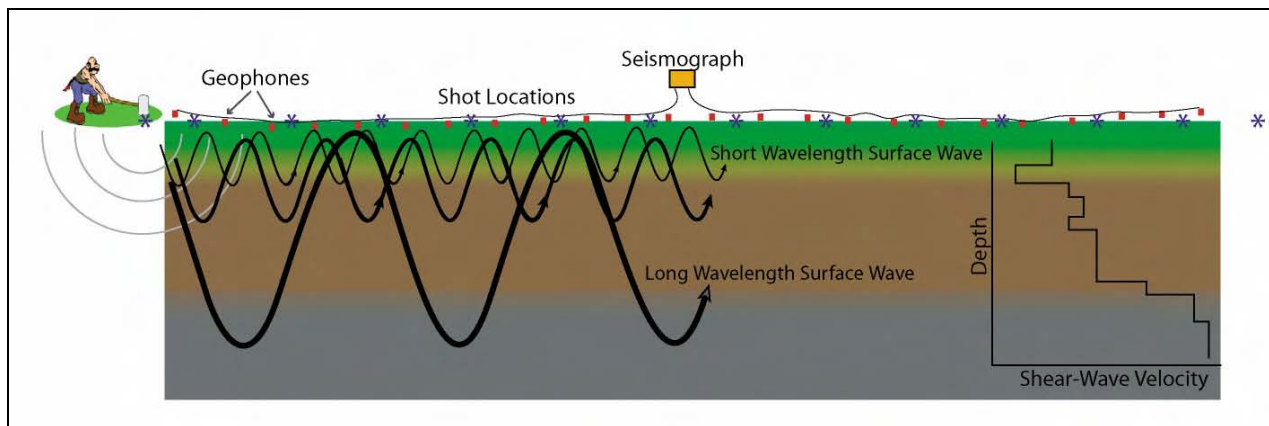

FIGURE 3
MASW Operating Principle

¹ NBCC. 2005. National Building Code of Canada 2005. Institute for Research in Construction, National Research Council of Canada, Ottawa, Ont.



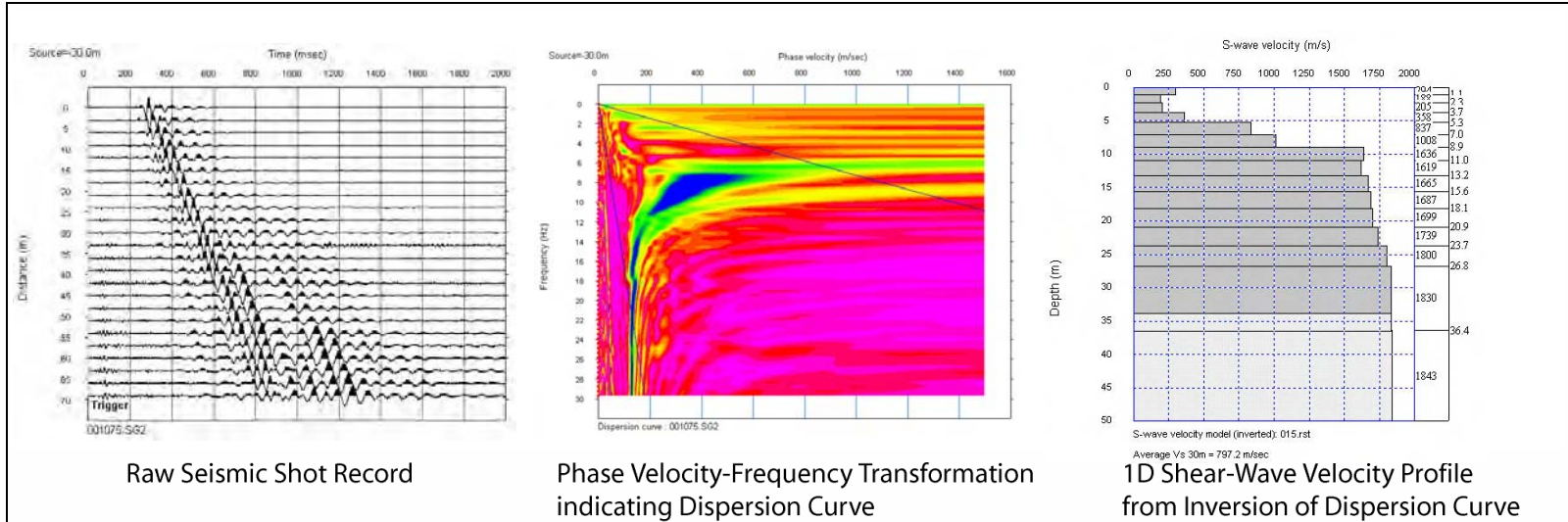

FIGURE 4
Example of a typical MASW shot record, phase velocity/frequency curve and resulting 1D shear wave velocity model



4. **RESULTS**

The MASW sounding results for each site investigated are presented in Appendix A. For each site, details of the V_{S30} calculations are presented in the table at the left of the 1D sounding profile. Site specific notes are included in each result sheet. As reference, the NBCC site classification is also indicated.

Table 1 shows the site coordinates provided by Groupe ABS.

The majority of the sites investigated show a similar velocity vs. depth distribution. This trend is characterized by a low velocity surface layer of a thickness of about 4 to 10 metres. In most cases, this layer shows abnormally low values that could be associated with a soil with liquefaction potential.

The low velocity layer is followed by an intermediate layer of variable thickness with an increasing V_S velocity in function of depth. Finally, a high velocity layer (bedrock in most cases) is detected beneath the intermediate layer. The high velocity layer is characterized by almost constant V_S . The velocity of this layer increases slightly with depth.

The MASW soundings were divided into five (5) groups in relation to their geographical position within the Saint-Valentin region. Average velocities for the three main layers and the average V_{S30} were computed and are presented in Table 2. These results indicate that the sounding sites within groups M and O show very low V_S velocities within the surface layer. Groups M and O are located to the South and South-East of Saint-Valentin.

In the case of the intermediate layer, it is groups N and O that show the lowest V_S velocities. These groups are located to the East and South of Saint-Valentin.

Group N shows the lowest average velocities for the hard layer. Borehole results indicate that the bedrock is located at depths over 30 metres in this area. Therefore, the measured shear wave velocities are only representative of the overburden in this area. This group also shows the lowest V_{S30} values of all five groups.



Overall, it is the sounding sites within group Q that show the highest shear wave velocities for all three principal layers as well as the average V_{S30} value. Group Q is the only group that does not have one or several sites with abnormally low V_S values for the surface layer that could be associated with a soil with liquefaction potential. Group Q is located at the North-East of Saint-Valentin.



TABLE 1 - MASW sounding site coordinates (MTM, NAD83, zone 8)

Site	Xc_MTM	Yc_MTM
4	316203	4994292
5	316239	5001777
6	316202	4994943
7	316244	5002438
8	316248	4998369
9	316478	5001418
10	316497	5002120
11	316592	4994528
12	316596	4994055
13	316618	4998175
14	316620	4994936
16	316876	5001955
17A	317102	5001353
18	317273	5002650
20A	317482	5002277
21A	318008	5002258
22	318187	5001293
23	318195	5001745
25	319312	4997246
26	319774	5001316
27	319664	4996999
28	319665	4997492
28A	319414	4997499
29	319828	5002096
30	320091	5001646
31	320095	4997479
31A	319926	4997484
32	320241	5002214
34	319415	5002922
35	319169	5002673
37	318483	5001515

coordinates provided by Groupe ABS



TABLE 2 – Average velocities vs. geographical groups

GROUP	SITES	AVERAGE VELOCITIES (m/s)			
		surface layer	intermediate layer	hard layer or bedrock	V _{S30}
M	4, 6, 11, 12, 14	134	742	1426	399
N	8, 13	245	590	1105	386
O	25, 27, 28, 28A, 31, 31A	150	575	1343	480
P	5, 7, 9, 10, 16, 17A, 18, 20A, 21A, 22, 23, 37	207	756	1400	606
Q	26, 29, 30, 32, 34, 35	264	880	1548	802
Average for all 31 sites		198	732	1403	572



5. **CONCLUSION**

Geophysical investigations with the MASW seismic method were carried out on 31 sites in the region of the town of Saint-Valentin, Québec. These surveys were part of the geotechnical studies for a wind farm project in the area.

The surveys allowed calculating the average shear wave velocities from the surface to a depth of 30 metres (V_{S30}). These values can be used to determine the Site Classification for Seismic Site Response, as presented in the National Building Code of Canada.

Results show that the 18 sites located at the north of the town of Saint-Valentin show higher V_{S30} values than the 13 sites located at the south of the town. A high number of the sites investigated show the presence of a surface layer with abnormally low shear wave velocity values that could be associated with a soil with liquefaction potential. Further geotechnical assessments are recommended for these sites.

It must be noted that other geotechnical information gleaned onsite; including the rock depth, the presence of liquefiable soils, soft clays, high moisture content etc. can supersede the site classification provided in this report based on V_{S30} value.

This report has been written by Daniel Campos Halas, Eng., M.A.Sc., with the collaboration of Jean-Luc Arsenault, Eng., M.A.Sc.

Daniel Campos Halas, Eng., M.Sc.A.
Project Manager
(O.I.Q member: 130386)

Jean-Luc Arsenault, Eng., M.Sc.A.
Project Manager
(O.I.Q member: 45316)



APPENDIX A – MASW SOUNDING RESULTS



Groupe ABS / Wind Energy Converters (WEC) / Saint-Valentin, Qc

Depth (m)	Vs (m/s)	Thickness (m)	Cumulated thickness (m)	Delay for med. Vs (s)	Cumulated delay (s)	Average Vs at given depth (m/s)
0.00	78.4					
1.07	79.3	1.07	1.07	0.013658	0.013658	78.4
2.31	78.4	1.24	2.31	0.015584	0.029242	78.9
3.71	128.7	1.40	3.71	0.017871	0.047113	78.7
5.27	433.1	1.57	5.27	0.012164	0.059276	89.0
7.01	699.1	1.73	7.01	0.003996	0.063272	110.7
8.90	867.2	1.90	8.90	0.002712	0.065984	134.9
10.96	1599.3	2.06	10.96	0.002376	0.068360	160.4
13.19	1613.4	2.23	13.19	0.001391	0.069751	189.1
15.58	1600.6	2.39	15.58	0.001481	0.071233	218.7
18.13	1582.1	2.55	18.13	0.001596	0.072829	249.0
20.85	1572.5	2.72	20.85	0.001719	0.074548	279.7
23.74	1748.5	2.88	23.74	0.001834	0.076382	310.8
26.79	1801.1	3.05	26.79	0.001744	0.078126	342.9
30.00	1952.1	3.21	30.00	0.001785	0.079911	375.4

Location

Sounding:	X (m)	Y (m)
MTM/Nad83	316203	4994292

Vs30 (m/s) =	375.4
Class :	C

NOTES :

- 1- The Vs values express estimated in-situ shear wave velocities; they were not corrected for the vertical effective overburden stress.
- 2- The Vs values for the first 4-5 meters are abnormally low. This could be related to a soil with a liquefaction potential. An adequate geotechnical accessment should be made to ensure that the site class remains C, or be re-classified as a F.

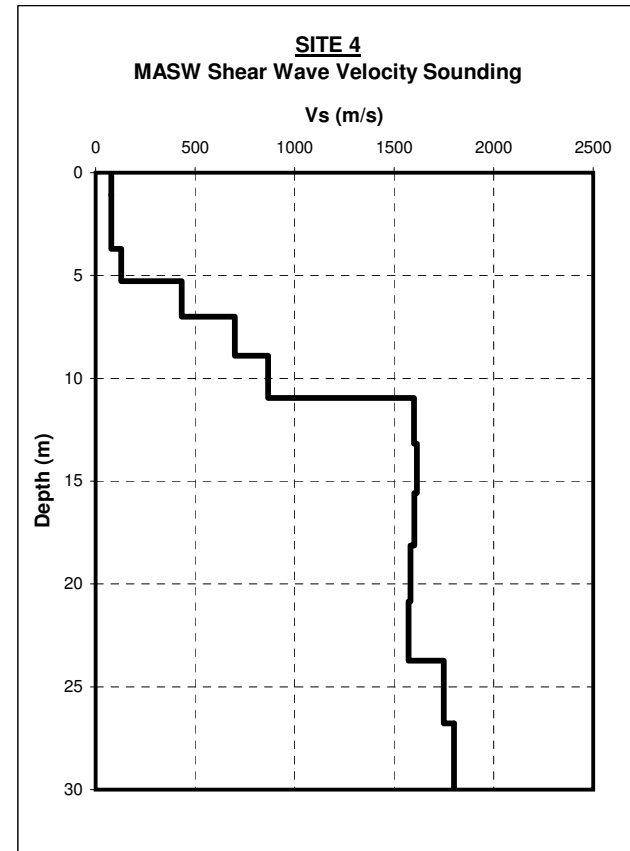

Groupe ABS / Wind Energy Converters (WEC) / Saint-Valentin, Qc

Depth (m)	Vs (m/s)	Thickness (m)	Cumulated thickness (m)	Delay for med. Vs (s)	Cumulated delay (s)	Average Vs at given depth (m/s)
0.00	205.9					
1.07	190.3	1.07	1.07	0.005204	0.005204	205.9
2.31	165.8	1.24	2.31	0.006496	0.011701	197.2
3.71	175.9	1.40	3.71	0.008450	0.020151	184.1
5.27	315.4	1.57	5.27	0.008901	0.029051	181.6
7.01	589.9	1.73	7.01	0.005488	0.034539	202.8
8.90	1060.5	1.90	8.90	0.003214	0.037753	235.8
10.96	1267.8	2.06	10.96	0.001943	0.039696	276.1
13.19	1294.8	2.23	13.19	0.001755	0.041451	318.1
15.58	1377.5	2.39	15.58	0.001846	0.043297	359.8
18.13	1444.0	2.55	18.13	0.001855	0.045152	401.6
20.85	1492.5	2.72	20.85	0.001883	0.047035	443.3
23.74	1513.7	2.88	23.74	0.001933	0.048968	484.7
26.79	1528.6	3.05	26.79	0.002015	0.050983	525.4
30.00	1546.9	3.21	30.00	0.002103	0.053085	565.1

Location

Sounding:	<u>X (m)</u>	<u>Y (m)</u>
MTM/Nad83	316239	5001777

Vs30 (m/s)	565.1
Class :	C

NOTES :

- 1- The Vs values express estimated in-situ shear wave velocities; they were not corrected for the vertical effective overburden stress.
- 2- The Vs values for the first 4-5 meters are abnormally low. This could be related to a soil with a liquefaction potential. An adequate geotechnical assessment should be made to ensure that the site class remains C, or be re-classified as a F.
- 3- The site coordinates were provided by the client.

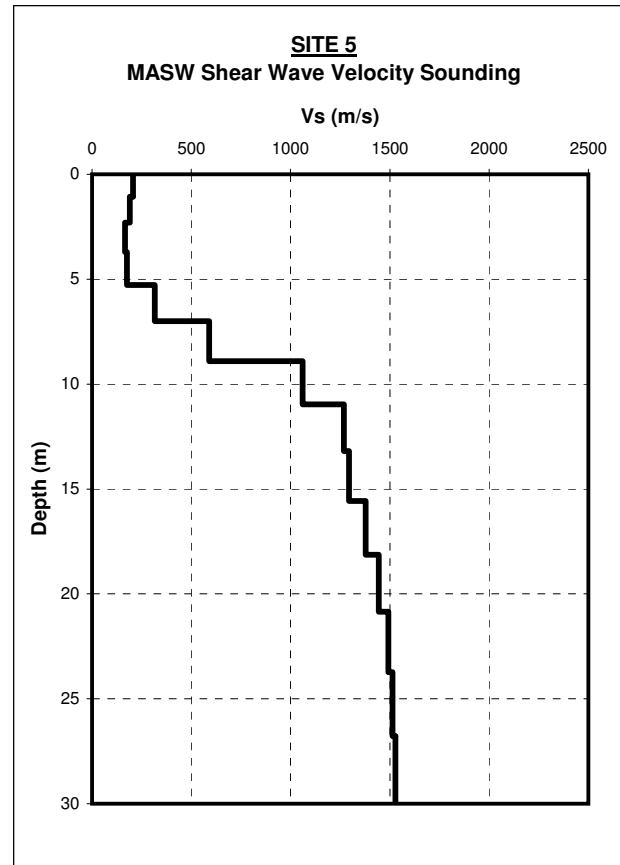

Groupe ABS / Wind Energy Converters (WEC) / Saint-Valentin, Qc

Depth (m)	Vs (m/s)	Thickness (m)	Cumulated thickness (m)	Delay for med. Vs (s)	Cumulated delay (s)	Average Vs at given depth (m/s)
0.00	136.2726					
1.07	81.73054	1.07	1.07	0.007862	0.007862	136.3
2.31	133.5603	1.24	2.31	0.015126	0.022988	100.4
3.71	129.1482	1.40	3.71	0.010490	0.033479	110.8
5.27	240.9045	1.57	5.27	0.012125	0.045604	115.7
7.01	239.3755	1.73	7.01	0.007184	0.052788	132.7
8.90	259.3235	1.90	8.90	0.007919	0.060707	146.6
10.96	615.7848	2.06	10.96	0.007945	0.068653	159.7
13.19	1085.137	2.23	13.19	0.003614	0.072267	182.5
15.58	1297.528	2.39	15.58	0.002203	0.074469	209.2
18.13	1372.757	2.55	18.13	0.001969	0.076438	237.2
20.85	1371.588	2.72	20.85	0.001981	0.078419	265.9
23.74	1388.833	2.88	23.74	0.002103	0.080523	294.8
26.79	1390.087	3.05	26.79	0.002196	0.082718	323.8
30.00	1641.913	3.21	30.00	0.002312	0.085031	352.8

Location

Sounding:	<u>X (m)</u>	<u>Y (m)</u>
MTM/Nad83	316202	4994943

Vs30 (m/s)	352.8
Class :	D

NOTES :

- 1- The Vs values express estimated in-situ shear wave velocities; they were not corrected for the vertical effective overburden stress.
- 2- The Vs values for the first 4-5 meters are abnormally low. This could be related to a soil with a liquefaction potential. An adequate geotechnical assessment should be made to ensure that the site class remains D, or be re-classified as a F.

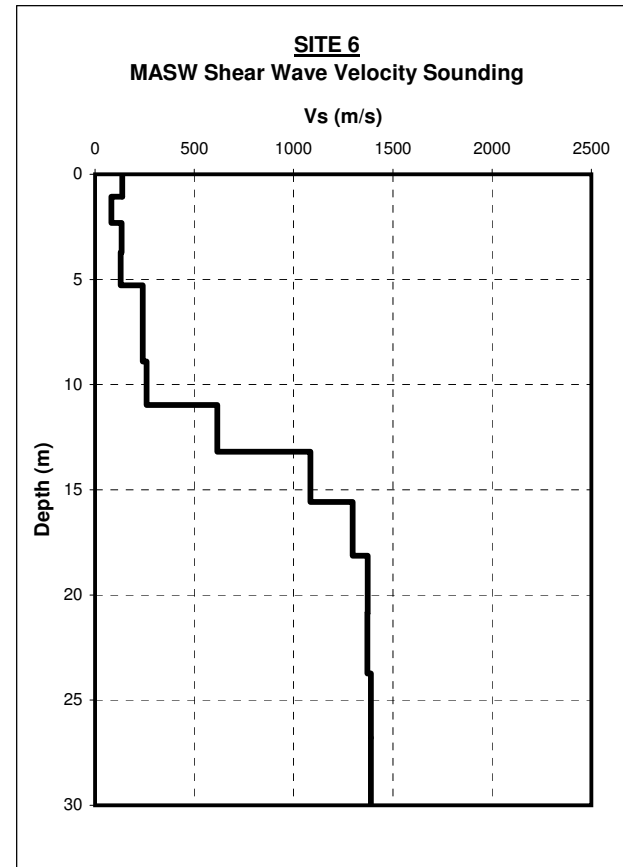

Groupe ABS / Wind Energy Converters (WEC) / Saint-Valentin, Qc

Depth (m)	Vs (m/s)	Thickness (m)	Cumulated thickness (m)	Delay for med. Vs (s)	Cumulated delay (s)	Average Vs at given depth (m/s)
0.00	258.6					
1.07	149.0	1.07	1.07	0.004144	0.004144	258.6
2.31	167.1	1.24	2.31	0.008297	0.012441	185.5
3.71	270.7	1.40	3.71	0.008386	0.020827	178.1
5.27	374.1	1.57	5.27	0.005785	0.026612	198.2
7.01	492.8	1.73	7.01	0.004627	0.031238	224.3
8.90	385.9	1.90	8.90	0.003847	0.035085	253.7
10.96	691.3	2.06	10.96	0.005340	0.040425	271.2
13.19	1307.8	2.23	13.19	0.003219	0.043644	302.1
15.58	1401.2	2.39	15.58	0.001828	0.045471	342.6
18.13	1464.8	2.55	18.13	0.001823	0.047295	383.4
20.85	1485.6	2.72	20.85	0.001857	0.049152	424.2
23.74	1490.0	2.88	23.74	0.001942	0.051093	464.6
26.79	1667.5	3.05	26.79	0.002047	0.053140	504.1
30.00	2141.1	3.21	30.00	0.001928	0.055068	544.8

Location

Sounding:	X (m)	Y (m)
MTM/Nad83	316244	5002438

Vs30 (m/s)	544.8
Class :	C

NOTES :

- 1- The Vs values express estimated in-situ shear wave velocities; they were not corrected for the vertical effective overburden stress.
- 2- The Vs values for the first 3-4 meters are abnormally low. This could be related to a soil with a liquefaction potential. An adequate geotechnical assessment should be made to ensure that the site class remains C, or be re-classified as a F.
- 3- The site coordinates were provided by the client.

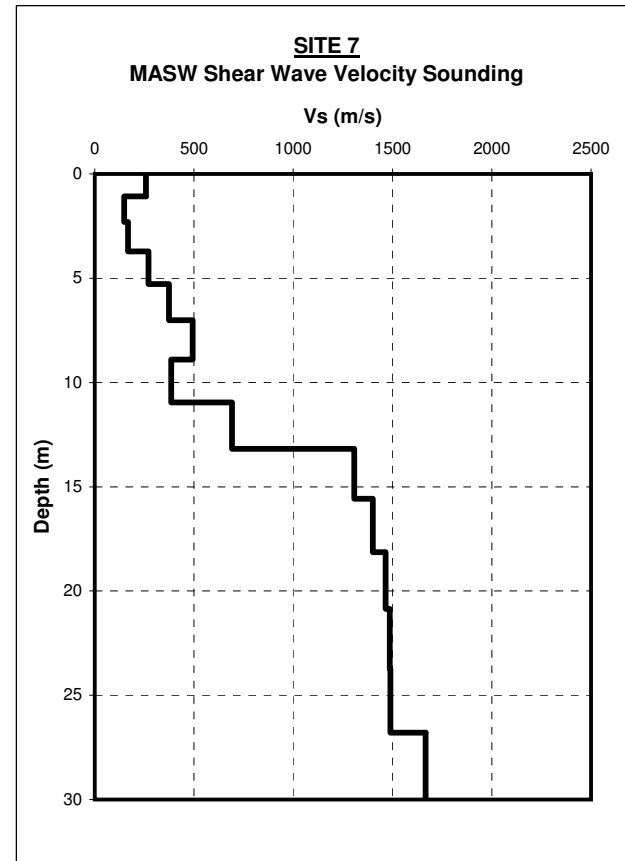

Groupe ABS / Wind Energy Converters (WEC) / Saint-Valentin, Qc

Depth (m)	Vs (m/s)	Thickness (m)	Cumulated thickness (m)	Delay for med. Vs (s)	Cumulated delay (s)	Average Vs at given depth (m/s)
0.00	153.4					
1.07	194.3	1.07	1.07	0.006984	0.006984	153.4
2.31	229.9	1.24	2.31	0.006362	0.013347	172.9
3.71	258.1	1.40	3.71	0.006095	0.019442	190.8
5.27	246.4	1.57	5.27	0.006067	0.025509	206.8
7.01	261.6	1.73	7.01	0.007024	0.032534	215.3
8.90	346.6	1.90	8.90	0.007245	0.039779	223.8
10.96	480.9	2.06	10.96	0.005944	0.045723	239.7
13.19	501.4	2.23	13.19	0.004627	0.050350	261.9
15.58	518.2	2.39	15.58	0.004767	0.055117	282.6
18.13	546.1	2.55	18.13	0.004931	0.060048	302.0
20.85	649.1	2.72	20.85	0.004980	0.065028	320.7
23.74	974.0	2.88	23.74	0.004444	0.069472	341.7
26.79	1336.1	3.05	26.79	0.003131	0.072603	368.9
30.00	1365.0	3.21	30.00	0.002406	0.075008	400.0

Location

Sounding:	X (m)	Y (m)
MTM/Nad83	316248	4998369

Vs30 (m/s)	400.0
Class :	C

NOTES :

- 1- The Vs values express estimated in-situ shear wave velocities; they were not corrected for the vertical effective overburden stress.

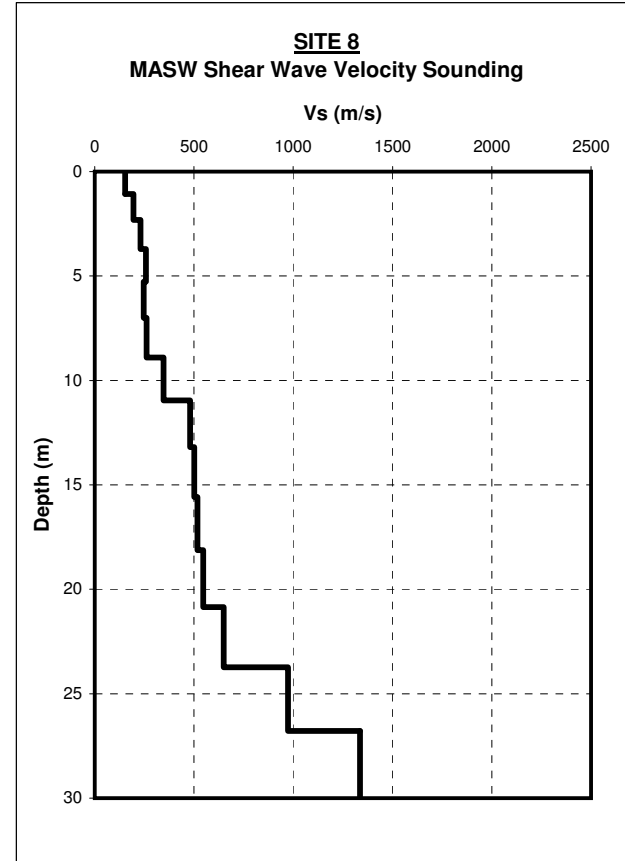

Groupe ABS / Wind Energy Converters (WEC) / Saint-Valentin, Qc

Depth (m)	Vs (m/s)	Thickness (m)	Cumulated thickness (m)	Delay for med. Vs (s)	Cumulated delay (s)	Average Vs at given depth (m/s)
0.00	277.3					
1.07	156.0	1.07	1.07	0.003864	0.003864	277.3
2.31	172.6	1.24	2.31	0.007924	0.011789	195.8
3.71	438.9	1.40	3.71	0.008118	0.019907	186.3
5.27	242.0	1.57	5.27	0.003568	0.023474	224.7
7.01	579.4	1.73	7.01	0.007153	0.030627	228.7
8.90	989.6	1.90	8.90	0.003272	0.033899	262.6
10.96	1311.4	2.06	10.96	0.002082	0.035981	304.6
13.19	1364.2	2.23	13.19	0.001697	0.037678	350.0
15.58	1602.4	2.39	15.58	0.001752	0.039430	395.1
18.13	1600.3	2.55	18.13	0.001594	0.041024	442.0
20.85	1685.3	2.72	20.85	0.001699	0.042724	488.1
23.74	1601.3	2.88	23.74	0.001712	0.044435	534.2
26.79	1551.2	3.05	26.79	0.001904	0.046340	578.0
30.00	2728.1	3.21	30.00	0.002072	0.048412	619.7

Location

Sounding:	X (m)	Y (m)
MTM/Nad83	316478	5001418

Vs30 (m/s)	619.7
Class :	C

NOTES :

- 1- The Vs values express estimated in-situ shear wave velocities; they were not corrected for the vertical effective overburden stress.
- 2- The Vs values for the first 2-4 meters are abnormally low. This could be related to a soil with a liquefaction potential. An adequate geotechnical assessment should be made to ensure that the site class remains C, or be re-classified as a F.

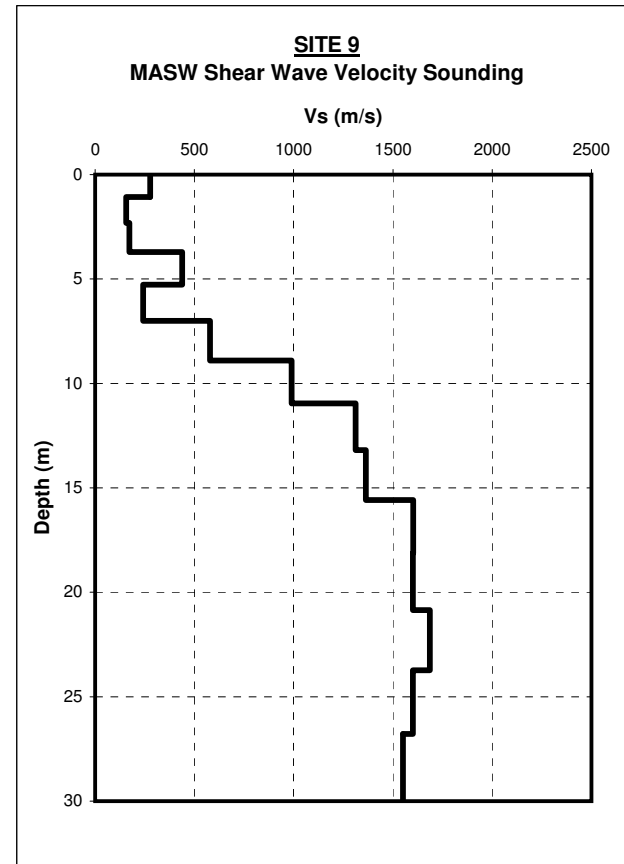

Groupe ABS / Wind Energy Converters (WEC) / Saint-Valentin, Qc

Depth (m)	Vs (m/s)	Thickness (m)	Cumulated thickness (m)	Delay for med. Vs (s)	Cumulated delay (s)	Average Vs at given depth (m/s)
0.00	310.9					
1.07	140.2	1.07	1.07	0.003446	0.003446	310.9
2.31	341.8	1.24	2.31	0.008818	0.012264	188.2
3.71	297.5	1.40	3.71	0.004099	0.016362	226.7
5.27	400.3	1.57	5.27	0.005264	0.021626	243.9
7.01	501.6	1.73	7.01	0.004324	0.025950	270.0
8.90	545.6	1.90	8.90	0.003779	0.029729	299.4
10.96	679.2	2.06	10.96	0.003776	0.033505	327.2
13.19	778.2	2.23	13.19	0.003276	0.036781	358.5
15.58	827.0	2.39	15.58	0.003071	0.039853	390.9
18.13	853.9	2.55	18.13	0.003090	0.042942	422.2
20.85	826.7	2.72	20.85	0.003185	0.046127	452.0
23.74	840.3	2.88	23.74	0.003489	0.049617	478.4
26.79	1136.0	3.05	26.79	0.003629	0.053246	503.1
30.00	1492.2	3.21	30.00	0.002829	0.056075	535.0

Location

Sounding:	<u>X (m)</u>	<u>Y (m)</u>
MTM/Nad83	316497	5002120

Vs30 (m/s)	535.0
Class :	C

NOTES :

- 1- The Vs values express estimated in-situ shear wave velocities; they were not corrected for the vertical effective overburden stress.

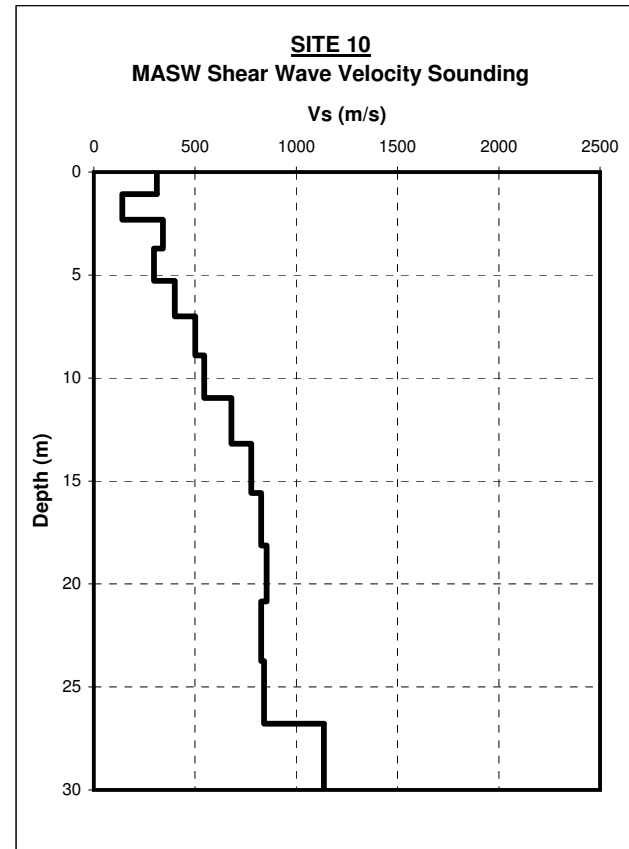

Groupe ABS / Wind Energy Converters (WEC) / Saint-Valentin, Qc

Depth (m)	Vs (m/s)	Thickness (m)	Cumulated thickness (m)	Delay for med. Vs (s)	Cumulated delay (s)	Average Vs at given depth (m/s)
0.00	98.2					
1.07	111.7	1.07	1.07	0.010915	0.010915	98.2
2.31	108.4	1.24	2.31	0.011066	0.021980	105.0
3.71	170.0	1.40	3.71	0.012924	0.034904	106.3
5.27	203.8	1.57	5.27	0.009212	0.044116	119.6
7.01	226.4	1.73	7.01	0.008492	0.052608	133.2
8.90	621.0	1.90	8.90	0.008374	0.060982	146.0
10.96	833.5	2.06	10.96	0.003318	0.064300	170.5
13.19	1179.2	2.23	13.19	0.002670	0.066970	196.9
15.58	1415.3	2.39	15.58	0.002027	0.068997	225.8
18.13	1435.3	2.55	18.13	0.001805	0.070802	256.1
20.85	1447.4	2.72	20.85	0.001895	0.072697	286.8
23.74	1456.4	2.88	23.74	0.001993	0.074690	317.8
26.79	1471.5	3.05	26.79	0.002094	0.076784	348.8
30.00	1507.5	3.21	30.00	0.002184	0.078968	379.9

Location

Sounding:	X (m)	Y (m)
MTM/Nad83	316592	4994528

Vs30 (m/s)	379.9
Class :	C

NOTES :

- 1- The Vs values express estimated in-situ shear wave velocities; they were not corrected for the vertical effective overburden stress.
- 2- The Vs values for the first 4-5 meters are abnormally low. This could be related to a soil with a liquefaction potential. An adequate geotechnical assessment should be made to ensure that the site class remains C, or be re-classified as a F.

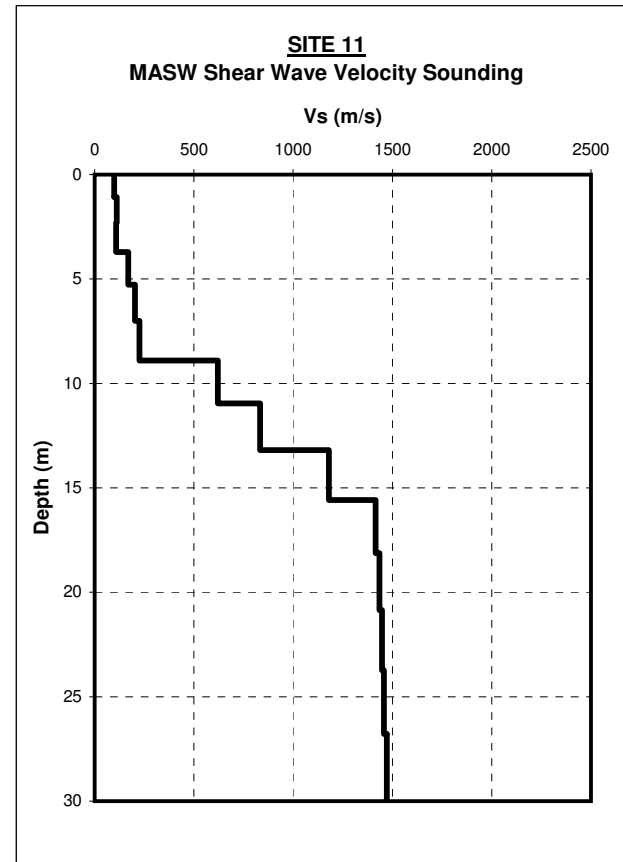

Groupe ABS / Wind Energy Converters (WEC) / Saint-Valentin, Qc

Depth (m)	Vs (m/s)	Thickness (m)	Cumulated thickness (m)	Delay for med. Vs (s)	Cumulated delay (s)	Average Vs at given depth (m/s)
0.00	129.2					
1.07	96.3	1.07	1.07	0.008291	0.008291	129.2
2.31	111.0	1.24	2.31	0.012842	0.021133	109.2
3.71	223.8	1.40	3.71	0.012621	0.033753	109.9
5.27	236.8	1.57	5.27	0.006998	0.040752	129.4
7.01	728.5	1.73	7.01	0.007310	0.048061	145.8
8.90	753.7	1.90	8.90	0.002602	0.050663	175.7
10.96	764.1	2.06	10.96	0.002734	0.053397	205.3
13.19	774.5	2.23	13.19	0.002912	0.056309	234.2
15.58	1173.5	2.39	15.58	0.003086	0.059395	262.3
18.13	1204.7	2.55	18.13	0.002177	0.061573	294.5
20.85	1237.6	2.72	20.85	0.002258	0.063830	326.7
23.74	1250.7	2.88	23.74	0.002331	0.066161	358.8
26.79	1265.4	3.05	26.79	0.002438	0.068599	390.5
30.00	1284.4	3.21	30.00	0.002540	0.071140	421.7

Location

Sounding:	X (m)	Y (m)
MTM/Nad83	316596	4994055

Vs30 (m/s)	421.7
Class :	C

NOTES :

- 1- The Vs values express estimated in-situ shear wave velocities; they were not corrected for the vertical effective overburden stress.
- 2- The Vs values for the first 4-7 meters are abnormally low. This could be related to a soil with a liquefaction potential. An adequate geotechnical assessment should be made to ensure that the site class remains C, or be re-classified as a F.

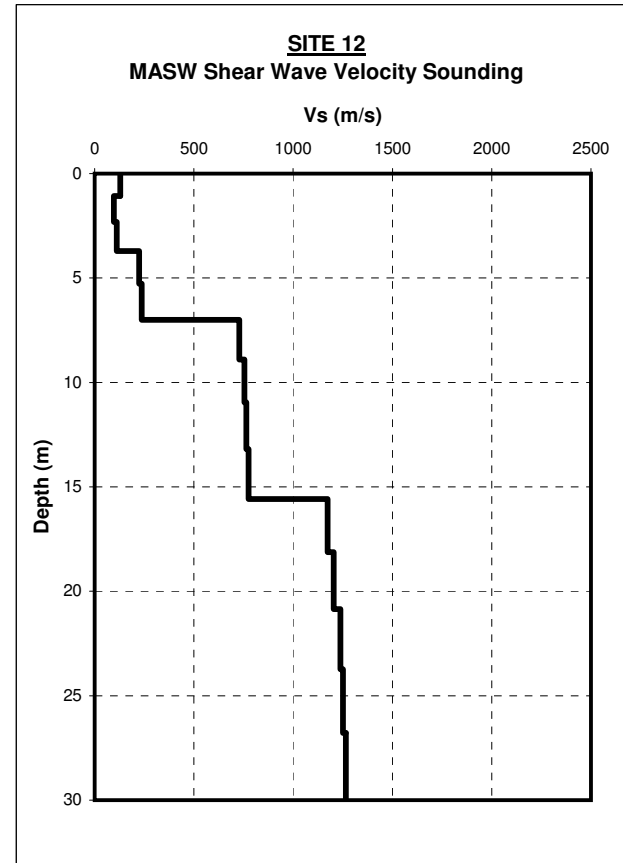

Groupe ABS / Wind Energy Converters (WEC) / Saint-Valentin, Qc

Depth (m)	Vs (m/s)	Thickness (m)	Cumulated thickness (m)	Delay for med. Vs (s)	Cumulated delay (s)	Average Vs at given depth (m/s)
0.00	354.5					
1.07	191.0	1.07	1.07	0.003022	0.003022	354.5
2.31	212.2	1.24	2.31	0.006474	0.009496	243.0
3.71	269.7	1.40	3.71	0.006602	0.016098	230.4
5.27	239.4	1.57	5.27	0.005806	0.021904	240.8
7.01	234.2	1.73	7.01	0.007230	0.029134	240.5
8.90	247.2	1.90	8.90	0.008095	0.037229	239.1
10.96	379.9	2.06	10.96	0.008336	0.045565	240.6
13.19	392.9	2.23	13.19	0.005858	0.051423	256.4
15.58	395.5	2.39	15.58	0.006083	0.057506	270.9
18.13	629.8	2.55	18.13	0.006460	0.063966	283.5
20.85	638.3	2.72	20.85	0.004319	0.068285	305.4
23.74	740.7	2.88	23.74	0.004519	0.072804	326.0
26.79	882.0	3.05	26.79	0.004117	0.076921	348.2
30.00	1468.3	3.21	30.00	0.003644	0.080565	372.4

Location

Sounding:	X (m)	Y (m)
MTM/Nad83	316618	4998175

Vs30 (m/s)	372.4
Class :	C

NOTES :

- 1- The Vs values express estimated in-situ shear wave velocities; they were not corrected for the vertical effective overburden stress.
- 2- The Vs values for the first 2-9 meters are abnormally low. This could be related to a soil with a liquefaction potential. An adequate geotechnical assessment should be made to ensure that the site class remains C, or be re-classified as a F.

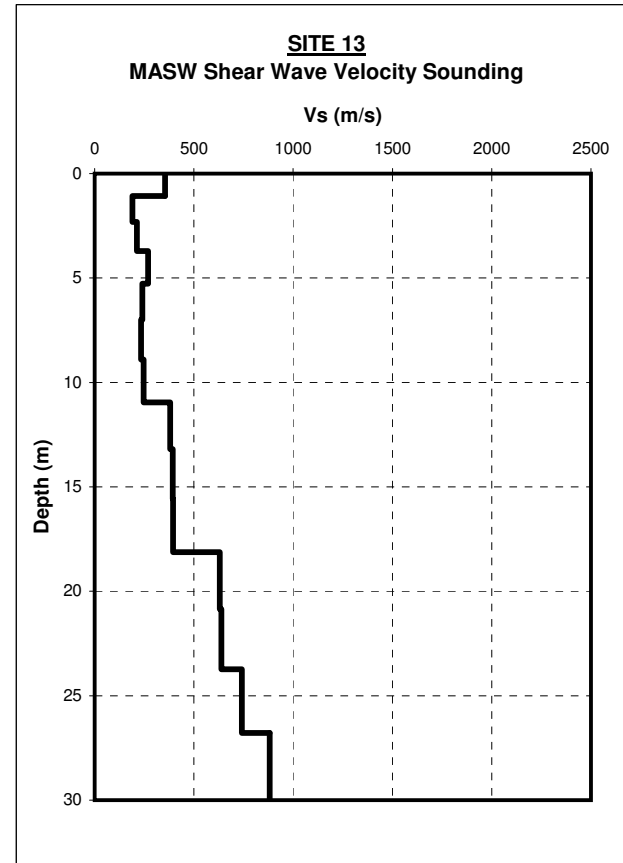

Groupe ABS / Wind Energy Converters (WEC) / Saint-Valentin, Qc

Depth (m)	Vs (m/s)	Thickness (m)	Cumulated thickness (m)	Delay for med. Vs (s)	Cumulated delay (s)	Average Vs at given depth (m/s)
0.00	131.3					
1.07	167.1	1.07	1.07	0.008159	0.008159	131.3
2.31	179.0	1.24	2.31	0.007398	0.015558	148.3
3.71	199.3	1.40	3.71	0.007825	0.023383	158.6
5.27	247.1	1.57	5.27	0.007858	0.031241	168.8
7.01	296.1	1.73	7.01	0.007003	0.038244	183.2
8.90	391.8	1.90	8.90	0.006402	0.044646	199.4
10.96	821.2	2.06	10.96	0.005258	0.049905	219.7
13.19	1210.4	2.23	13.19	0.002710	0.052614	250.6
15.58	1335.5	2.39	15.58	0.001975	0.054589	285.3
18.13	1398.5	2.55	18.13	0.001913	0.056502	320.9
20.85	1460.2	2.72	20.85	0.001945	0.058447	356.8
23.74	1560.7	2.88	23.74	0.001976	0.060422	392.8
26.79	1594.2	3.05	26.79	0.001954	0.062376	429.4
30.00	1648.6	3.21	30.00	0.002016	0.064392	465.9

Location

Sounding:	X (m)	Y (m)
MTM/Nad83	316620	4994936

Vs30 (m/s)	465.9
Class :	C

NOTES :

- 1- The Vs values express estimated in-situ shear wave velocities; they were not corrected for the vertical effective overburden stress.
- 2- The Vs values for the first 4-5 meters are abnormally low. This could be related to a soil with a liquefaction potential. An adequate geotechnical assessment should be made to ensure that the site class remains C, or be re-classified as a F.

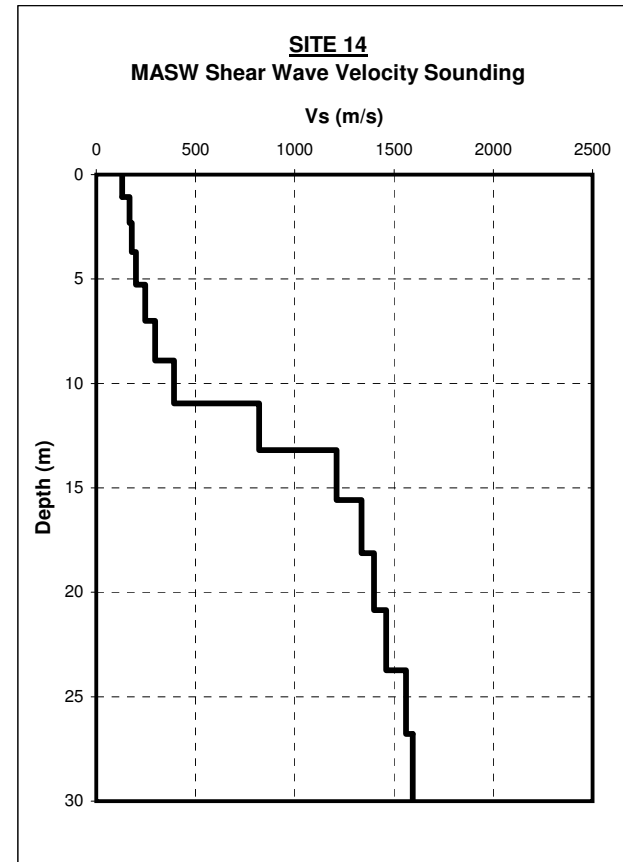

Groupe ABS / Wind Energy Converters (WEC) / Saint-Valentin, Qc

Depth (m)	Vs (m/s)	Thickness (m)	Cumulated thickness (m)	Delay for med. Vs (s)	Cumulated delay (s)	Average Vs at given depth (m/s)
0.00	245.8					
1.07	181.4	1.07	1.07	0.004358	0.004358	245.8
2.31	506.1	1.24	2.31	0.006816	0.011174	206.5
3.71	256.7	1.40	3.71	0.002768	0.013942	266.0
5.27	584.1	1.57	5.27	0.006101	0.020044	263.2
7.01	772.2	1.73	7.01	0.002963	0.023007	304.5
8.90	529.8	1.90	8.90	0.002455	0.025461	349.6
10.96	737.2	2.06	10.96	0.003889	0.029351	373.5
13.19	1581.0	2.23	13.19	0.003018	0.032369	407.4
15.58	1638.5	2.39	15.58	0.001512	0.033881	459.8
18.13	1641.9	2.55	18.13	0.001559	0.035440	511.6
20.85	1716.3	2.72	20.85	0.001656	0.037097	562.1
23.74	1696.1	2.88	23.74	0.001681	0.038777	612.1
26.79	1646.8	3.05	26.79	0.001798	0.040575	660.2
30.00	1716.3	3.21	30.00	0.001952	0.042527	705.4

Location

Sounding:	X (m)	Y (m)
MTM/Nad83	316876	5001955

Vs30 (m/s)	705.4
Class :	C

NOTES :

1- The Vs values express estimated in-situ shear wave velocities; they were not corrected for the vertical effective overburden stress.

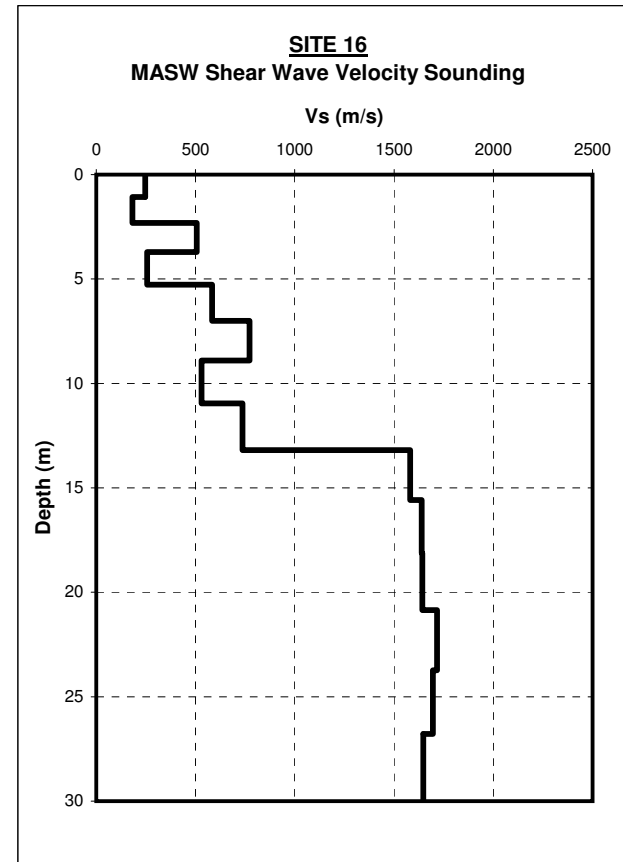

Groupe ABS / Wind Energy Converters (WEC) / Saint-Valentin, Qc

Depth (m)	Vs (m/s)	Thickness (m)	Cumulated thickness (m)	Delay for med. Vs (s)	Cumulated delay (s)	Average Vs at given depth (m/s)
0.00	115.0					
1.07	105.6	1.07	1.07	0.009318	0.009318	115.0
2.31	271.6	1.24	2.31	0.011706	0.021024	109.8
3.71	232.9	1.40	3.71	0.005158	0.026182	141.7
5.27	272.9	1.57	5.27	0.006725	0.032907	160.3
7.01	449.7	1.73	7.01	0.006342	0.039248	178.5
8.90	691.6	1.90	8.90	0.004215	0.043463	204.8
10.96	886.5	2.06	10.96	0.002979	0.046443	236.0
13.19	1010.1	2.23	13.19	0.002510	0.048953	269.4
15.58	1089.6	2.39	15.58	0.002366	0.051319	303.5
18.13	1137.1	2.55	18.13	0.002345	0.053664	337.9
20.85	1175.8	2.72	20.85	0.002392	0.056055	372.0
23.74	1295.0	2.88	23.74	0.002453	0.058509	405.7
26.79	1612.7	3.05	26.79	0.002355	0.060864	440.1
30.00	1751.3	3.21	30.00	0.001993	0.062857	477.3

Location

Sounding:	X (m)	Y (m)
MTM/Nad83	317102	5001353

Vs30 (m/s)	477.3
Class :	C

NOTES :

- 1- The Vs values express estimated in-situ shear wave velocities; they were not corrected for the vertical effective overburden stress.
- 2- The Vs values for the first 2-5 meters are abnormally low. This could be related to a soil with a liquefaction potential. An adequate geotechnical assessment should be made to ensure that the site class remains C, or be re-classified as a F.

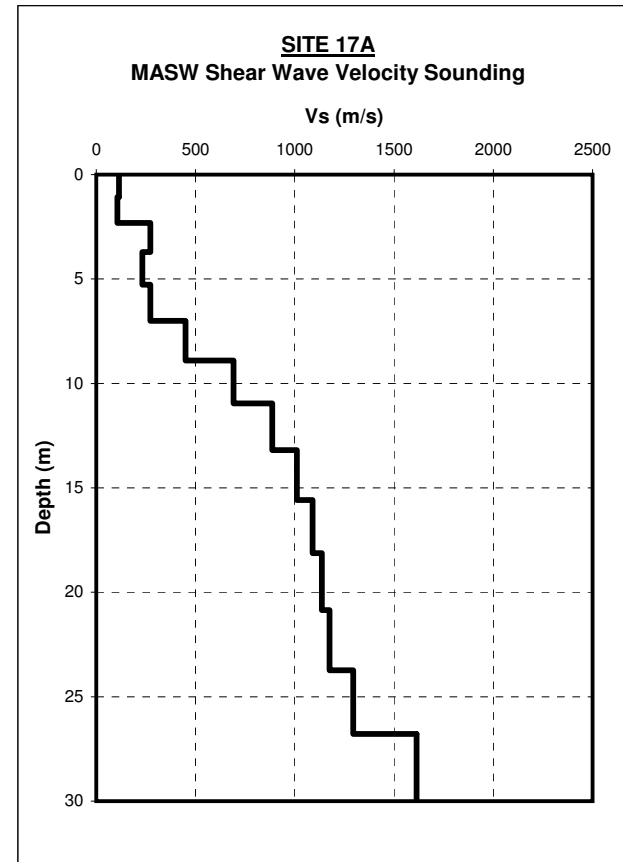

Groupe ABS / Wind Energy Converters (WEC) / Saint-Valentin, Qc

Depth (m)	Vs (m/s)	Thickness (m)	Cumulated thickness (m)	Delay for med. Vs (s)	Cumulated delay (s)	Average Vs at given depth (m/s)
0.00	158.9					
1.07	197.8	1.07	1.07	0.006743	0.006743	158.9
2.31	257.8	1.24	2.31	0.006251	0.012994	177.6
3.71	421.7	1.40	3.71	0.005434	0.018428	201.3
5.27	515.8	1.57	5.27	0.003713	0.022142	238.2
7.01	1145.7	1.73	7.01	0.003355	0.025497	274.8
8.90	1406.6	1.90	8.90	0.001655	0.027152	327.8
10.96	1416.0	2.06	10.96	0.001465	0.028616	383.0
13.19	1427.8	2.23	13.19	0.001572	0.030188	436.8
15.58	1440.0	2.39	15.58	0.001674	0.031862	488.9
18.13	1466.9	2.55	18.13	0.001774	0.033636	539.1
20.85	1486.0	2.72	20.85	0.001854	0.035490	587.5
23.74	1518.1	2.88	23.74	0.001941	0.037432	634.1
26.79	1548.8	3.05	26.79	0.002009	0.039440	679.1
30.00	1716.2	3.21	30.00	0.002075	0.041516	722.6

Location

Sounding:	X (m)	Y (m)
MTM/Nad83	317273	5002650

Vs30 (m/s)	722.6
Class :	C

NOTES :

- 1- The Vs values express estimated in-situ shear wave velocities; they were not corrected for the vertical effective overburden stress.
- 2- The site coordinates were provided by the client.

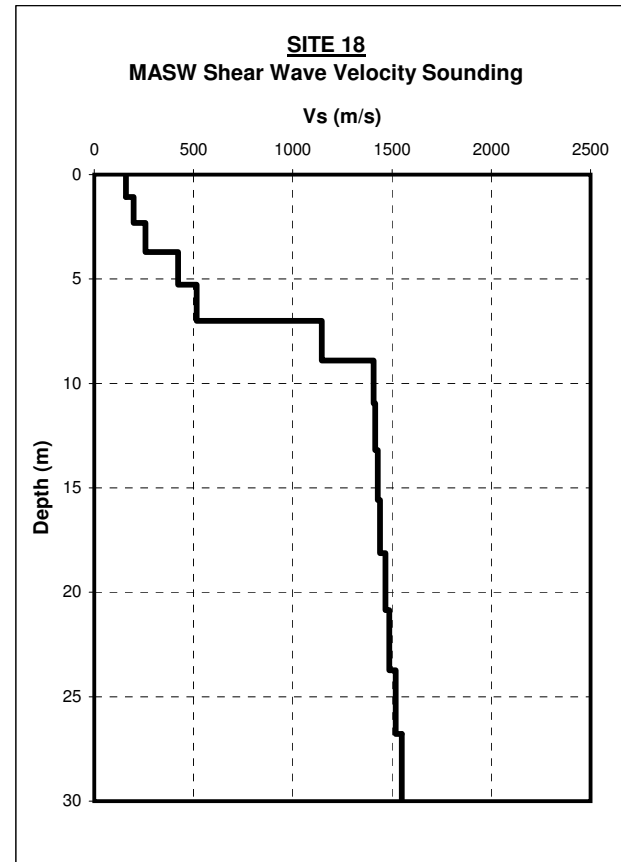

Groupe ABS / Wind Energy Converters (WEC) / Saint-Valentin, Qc

Depth (m)	Vs (m/s)	Thickness (m)	Cumulated thickness (m)	Delay for med. Vs (s)	Cumulated delay (s)	Average Vs at given depth (m/s)
0.00	155.2					
1.07	125.0	1.07	1.07	0.006902	0.006902	155.2
2.31	155.2	1.24	2.31	0.009888	0.016790	137.4
3.71	248.4	1.40	3.71	0.009026	0.025816	143.7
5.27	390.5	1.57	5.27	0.006305	0.032121	164.2
7.01	678.1	1.73	7.01	0.004432	0.036553	191.7
8.90	707.5	1.90	8.90	0.002795	0.039349	226.2
10.96	760.0	2.06	10.96	0.002912	0.042261	259.4
13.19	900.3	2.23	13.19	0.002928	0.045189	291.8
15.58	945.9	2.39	15.58	0.002655	0.047843	325.6
18.13	1111.1	2.55	18.13	0.002701	0.050544	358.7
20.85	1137.3	2.72	20.85	0.002448	0.052992	393.5
23.74	1330.1	2.88	23.74	0.002536	0.055529	427.5
26.79	1356.2	3.05	26.79	0.002293	0.057821	463.2
30.00	1790.8	3.21	30.00	0.002370	0.060191	498.4

Location

Sounding:	X (m)	Y (m)
MTM/Nad83	317482	5002277

Vs30 (m/s)	498.4
Class :	C

NOTES :

- 1- The Vs values express estimated in-situ shear wave velocities; they were not corrected for the vertical effective overburden stress.
- 2- The Vs values for the first 2-4 meters are abnormally low. This could be related to a soil with a liquefaction potential. An adequate geotechnical assessment should be made to ensure that the site class remains C, or be re-classified as a F.

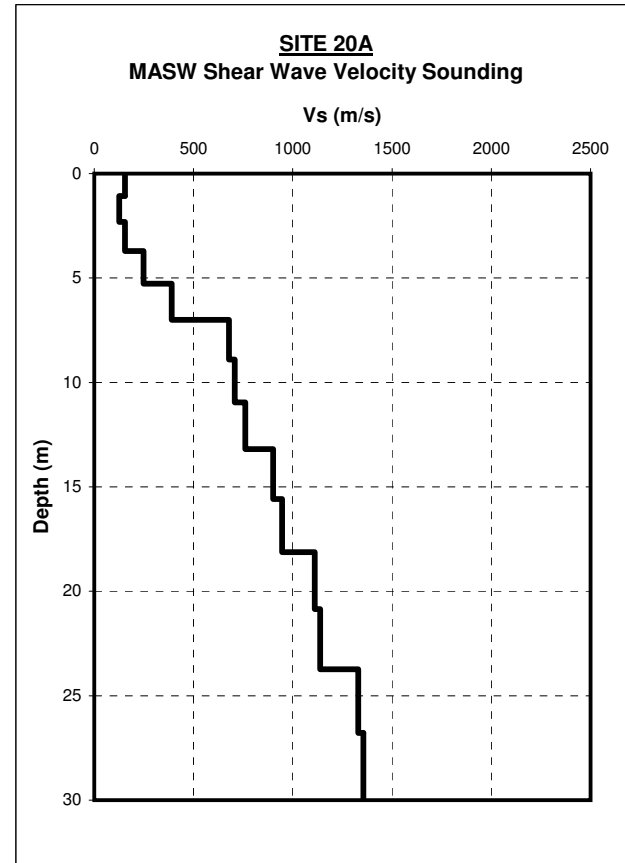

Groupe ABS / Wind Energy Converters (WEC) / Saint-Valentin, Qc

Depth (m)	Vs (m/s)	Thickness (m)	Cumulated thickness (m)	Delay for med. Vs (s)	Cumulated delay (s)	Average Vs at given depth (m/s)
0.00	820.2					
1.07	59.0	1.07	1.07	0.001306	0.001306	820.2
2.31	192.5	1.24	2.31	0.020965	0.022271	103.6
3.71	217.7	1.40	3.71	0.007279	0.029550	125.5
5.27	257.2	1.57	5.27	0.007192	0.036742	143.6
7.01	392.9	1.73	7.01	0.006728	0.043470	161.2
8.90	532.0	1.90	8.90	0.004825	0.048295	184.3
10.96	1395.4	2.06	10.96	0.003873	0.052168	210.1
13.19	1411.5	2.23	13.19	0.001595	0.053763	245.3
15.58	1411.5	2.39	15.58	0.001693	0.055456	280.9
18.13	1430.8	2.55	18.13	0.001810	0.057266	316.6
20.85	1442.7	2.72	20.85	0.001901	0.059167	352.4
23.74	1475.4	2.88	23.74	0.001999	0.061167	388.1
26.79	1515.5	3.05	26.79	0.002067	0.063234	423.6
30.00	1537.7	3.21	30.00	0.002121	0.065355	459.0

Location

Sounding:	X (m)	Y (m)
MTM/Nad83	318008	5002258

Vs30 (m/s)	459.0
Class :	C

NOTES :

- 1- The Vs values express estimated in-situ shear wave velocities; they were not corrected for the vertical effective overburden stress.
- 2- The Vs values for the first 4-5 meters are abnormally low. This could be related to a soil with a liquefaction potential. An adequate geotechnical assessment should be made to ensure that the site class remains C, or be re-classified as a F.
- 3- The site coordinates were provided by the client.

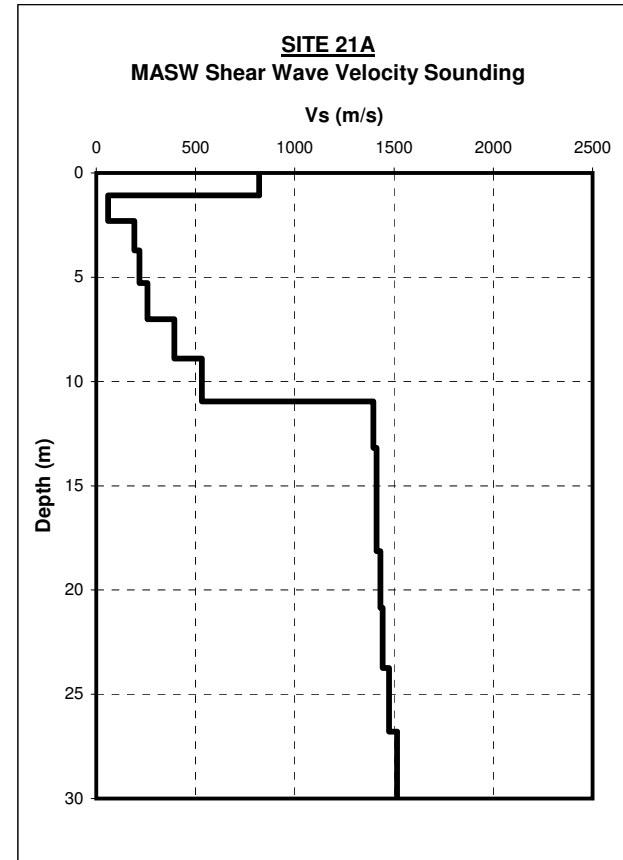

Groupe ABS / Wind Energy Converters (WEC) / Saint-Valentin, Qc

Depth (m)	Vs (m/s)	Thickness (m)	Cumulated thickness (m)	Delay for med. Vs (s)	Cumulated delay (s)	Average Vs at given depth (m/s)
0.00	225.7					
1.07	194.3	1.07	1.07	0.004748	0.004748	225.7
2.31	224.8	1.24	2.31	0.006363	0.011111	207.7
3.71	275.3	1.40	3.71	0.006233	0.017344	213.8
5.27	388.1	1.57	5.27	0.005687	0.023031	229.0
7.01	517.3	1.73	7.01	0.004460	0.027491	254.8
8.90	608.3	1.90	8.90	0.003664	0.031155	285.7
10.96	626.8	2.06	10.96	0.003387	0.034542	317.3
13.19	966.1	2.23	13.19	0.003550	0.038093	346.2
15.58	1099.7	2.39	15.58	0.002474	0.040567	384.0
18.13	1106.1	2.55	18.13	0.002323	0.042890	422.8
20.85	1121.1	2.72	20.85	0.002459	0.045349	459.8
23.74	1129.8	2.88	23.74	0.002573	0.047922	495.3
26.79	1199.6	3.05	26.79	0.002699	0.050621	529.1
30.00	1386.8	3.21	30.00	0.002680	0.053301	562.8

Location

Sounding:	X (m)	Y (m)
MTM/Nad83	318187	5001293

Vs30 (m/s)	562.8
Class :	C

NOTES :

- 1- The Vs values express estimated in-situ shear wave velocities; they were not corrected for the vertical effective overburden stress.
- 2- The Vs values for the first 4-5 meters are abnormally low. This could be related to a soil with a liquefaction potential. An adequate geotechnical assessment should be made to ensure that the site class remains C, or be re-classified as a F.

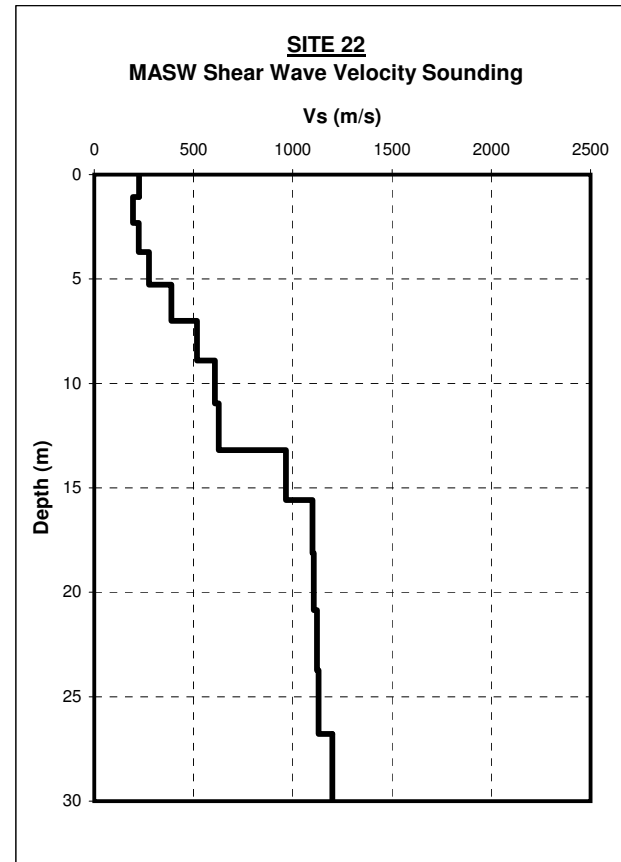

Groupe ABS / Wind Energy Converters (WEC) / Saint-Valentin, Qc

Depth (m)	Vs (m/s)	Thickness (m)	Cumulated thickness (m)	Delay for med. Vs (s)	Cumulated delay (s)	Average Vs at given depth (m/s)
0.00	119.6					
1.07	187.1	1.07	1.07	0.008957	0.008957	119.6
2.31	221.7	1.24	2.31	0.006606	0.015563	148.3
3.71	222.3	1.40	3.71	0.006321	0.021884	169.5
5.27	704.3	1.57	5.27	0.007045	0.028929	182.3
7.01	983.0	1.73	7.01	0.002457	0.031386	223.2
8.90	1212.6	1.90	8.90	0.001928	0.033315	267.2
10.96	1774.4	2.06	10.96	0.001699	0.035014	313.1
13.19	1862.9	2.23	13.19	0.001254	0.036268	363.6
15.58	1824.9	2.39	15.58	0.001283	0.037551	414.8
18.13	1798.4	2.55	18.13	0.001400	0.038951	465.5
20.85	1818.5	2.72	20.85	0.001512	0.040463	515.3
23.74	1901.6	2.88	23.74	0.001586	0.042050	564.5
26.79	1924.8	3.05	26.79	0.001604	0.043653	613.6
30.00	2437.9	3.21	30.00	0.001670	0.045323	661.9

Location

Sounding:	X (m)	Y (m)
MTM/Nad83	318195	5001745

Vs30 (m/s)	661.9
Class :	C

NOTES :

- 1- The Vs values express estimated in-situ shear wave velocities; they were not corrected for the vertical effective overburden stress.
- 2- The Vs values for the first 4-5 meters are abnormally low. This could be related to a soil with a liquefaction potential. An adequate geotechnical assessment should be made to ensure that the site class remains C, or be re-classified as a F.

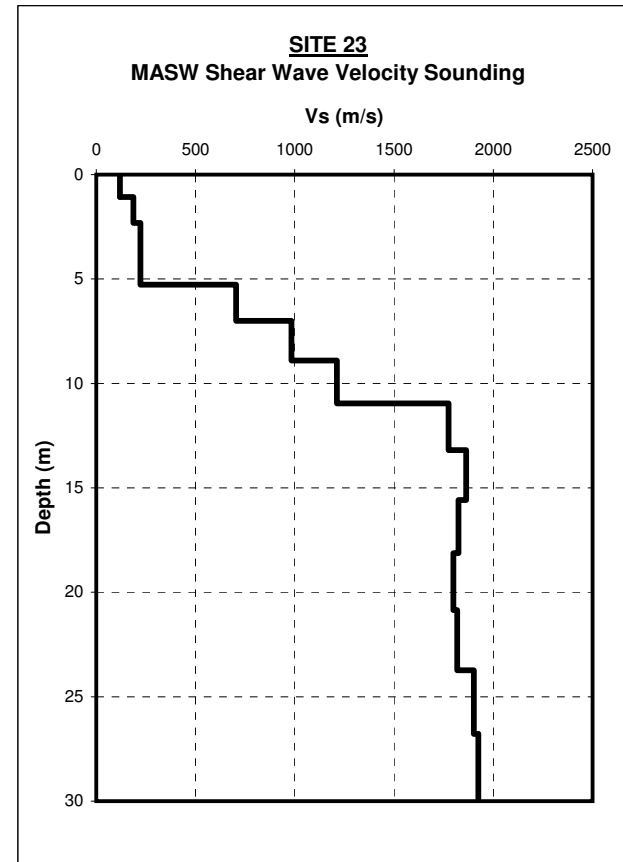

Groupe ABS / Wind Energy Converters (WEC) / Saint-Valentin, Qc

Depth (m)	Vs (m/s)	Thickness (m)	Cumulated thickness (m)	Delay for med. Vs (s)	Cumulated delay (s)	Average Vs at given depth (m/s)
0.00	123.0					
1.07	97.6	1.07	1.07	0.008714	0.008714	123.0
2.31	130.3	1.24	2.31	0.012669	0.021384	107.9
3.71	355.9	1.40	3.71	0.010754	0.032137	115.4
5.27	567.9	1.57	5.27	0.004400	0.036537	144.4
7.01	668.1	1.73	7.01	0.003048	0.039585	177.0
8.90	695.1	1.90	8.90	0.002837	0.042423	209.8
10.96	1014.1	2.06	10.96	0.002964	0.045387	241.5
13.19	1162.9	2.23	13.19	0.002194	0.047581	277.1
15.58	1166.1	2.39	15.58	0.002055	0.049637	313.8
18.13	1163.9	2.55	18.13	0.002191	0.051828	349.8
20.85	1196.4	2.72	20.85	0.002337	0.054164	385.0
23.74	1185.9	2.88	23.74	0.002411	0.056575	419.6
26.79	1182.8	3.05	26.79	0.002572	0.059147	452.9
30.00	1317.0	3.21	30.00	0.002717	0.061864	484.9

Location

Sounding:	X (m)	Y (m)
MTM/Nad83	319312	4997246

Vs30 (m/s)	484.9
Class :	C

NOTES :

- 1- The Vs values express estimated in-situ shear wave velocities; they were not corrected for the vertical effective overburden stress.
- 2- The Vs values for the first 4 meters are abnormally low. This could be related to a soil with a liquefaction potential. An adequate geotechnical assessment should be made to ensure that the site class remains C, or be re-classified as a F.

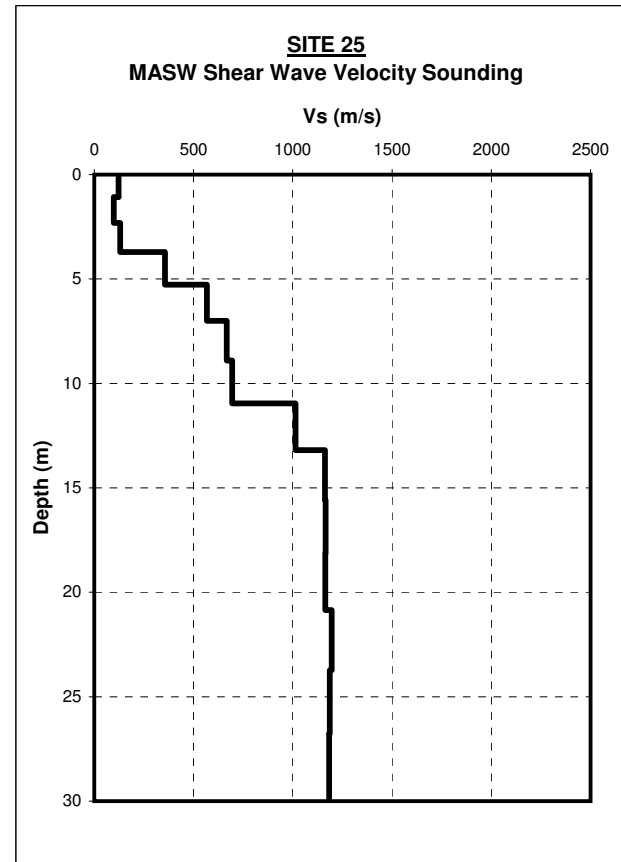

Groupe ABS / Wind Energy Converters (WEC) / Saint-Valentin, Qc

Depth (m)	Vs (m/s)	Thickness (m)	Cumulated thickness (m)	Delay for med. Vs (s)	Cumulated delay (s)	Average Vs at given depth (m/s)
0.00	173.4					
1.07	172.9	1.07	1.07	0.006178	0.006178	173.4
2.31	357.4	1.24	2.31	0.007152	0.013330	173.1
3.71	409.2	1.40	3.71	0.003920	0.017250	215.0
5.27	993.4	1.57	5.27	0.003827	0.021077	250.3
7.01	1144.9	1.73	7.01	0.001742	0.022820	307.0
8.90	1189.2	1.90	8.90	0.001656	0.024475	363.7
10.96	1241.8	2.06	10.96	0.001733	0.026208	418.3
13.19	1281.8	2.23	13.19	0.001792	0.028000	471.0
15.58	1324.5	2.39	15.58	0.001865	0.029865	521.6
18.13	1353.7	2.55	18.13	0.001929	0.031794	570.3
20.85	1395.9	2.72	20.85	0.002009	0.033803	616.9
23.74	1509.9	2.88	23.74	0.002066	0.035869	661.7
26.79	1643.0	3.05	26.79	0.002020	0.037889	707.0
30.00	2181.4	3.21	30.00	0.001956	0.039845	752.9

Location

Sounding:	X (m)	Y (m)
MTM/Nad83	319774	5001316

Vs30 (m/s)	752.9
Class :	C

NOTES :

1- The Vs values express estimated in-situ shear wave velocities; they were not corrected for the vertical effective overburden stress.

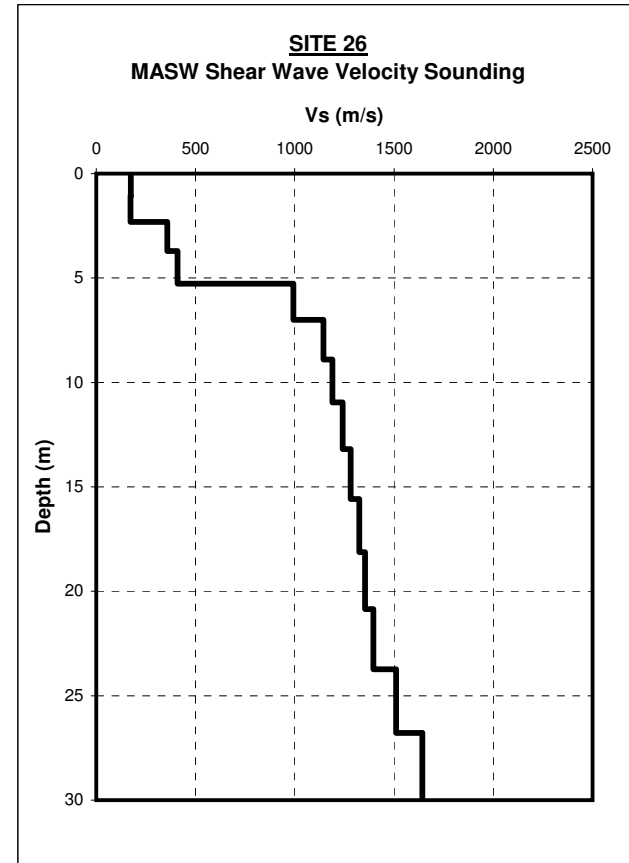

Groupe ABS / Wind Energy Converters (WEC) / Saint-Valentin, Qc

Depth (m)	Vs (m/s)	Thickness (m)	Cumulated thickness (m)	Delay for med. Vs (s)	Cumulated delay (s)	Average Vs at given depth (m/s)
0.00	169.3					
1.07	106.8	1.07	1.07	0.006330	0.006330	169.3
2.31	144.6	1.24	2.31	0.011578	0.017908	128.9
3.71	194.3	1.40	3.71	0.009688	0.027595	134.4
5.27	305.7	1.57	5.27	0.008058	0.035653	147.9
7.01	411.3	1.73	7.01	0.005661	0.041314	169.6
8.90	486.2	1.90	8.90	0.004609	0.045923	193.8
10.96	1175.8	2.06	10.96	0.004238	0.050161	218.5
13.19	1303.2	2.23	13.19	0.001893	0.052054	253.3
15.58	1331.4	2.39	15.58	0.001834	0.053888	289.1
18.13	1355.6	2.55	18.13	0.001919	0.055807	324.9
20.85	1371.4	2.72	20.85	0.002006	0.057813	360.7
23.74	1383.8	2.88	23.74	0.002103	0.059917	396.2
26.79	1445.2	3.05	26.79	0.002204	0.062120	431.2
30.00	1671.3	3.21	30.00	0.002224	0.064344	466.2

Location

Sounding:	X (m)	Y (m)
MTM/Nad83	319664	4996999

Vs30 (m/s)	466.2
Class :	C

NOTES :

- 1- The Vs values express estimated in-situ shear wave velocities; they were not corrected for the vertical effective overburden stress.
- 2- The Vs values for the first 4-5 meters are abnormally low. This could be related to a soil with a liquefaction potential. An adequate geotechnical assessment should be made to ensure that the site class remains C, or be re-classified as a F.

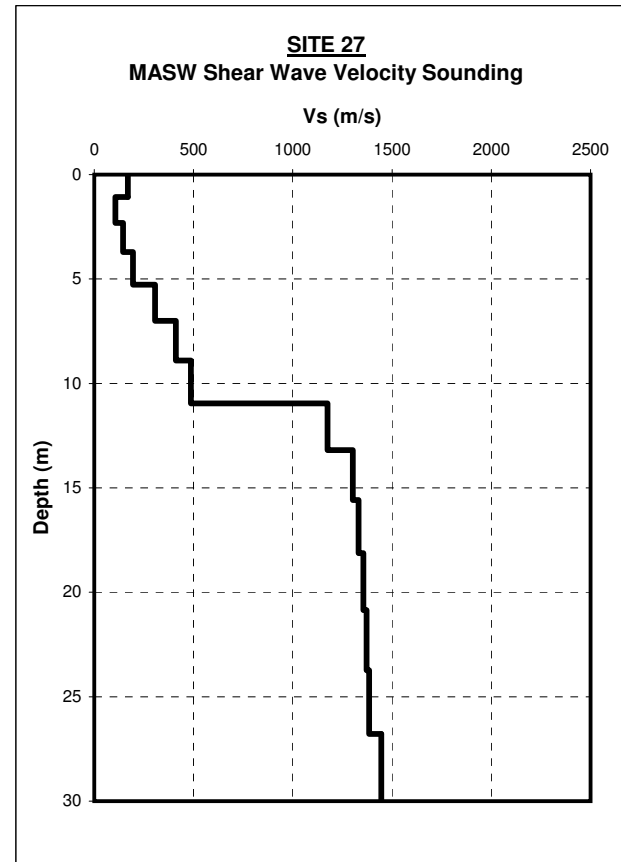

Groupe ABS / Wind Energy Converters (WEC) / Saint-Valentin, Qc

Depth (m)	Vs (m/s)	Thickness (m)	Cumulated thickness (m)	Delay for med. Vs (s)	Cumulated delay (s)	Average Vs at given depth (m/s)
0.00	177.6					
1.07	130.5	1.07	1.07	0.006035	0.006035	177.6
2.31	131.2	1.24	2.31	0.009473	0.015508	148.8
3.71	161.8	1.40	3.71	0.010677	0.026185	141.6
5.27	419.9	1.57	5.27	0.009679	0.035864	147.1
7.01	550.7	1.73	7.01	0.004122	0.039986	175.2
8.90	942.8	1.90	8.90	0.003442	0.043428	205.0
10.96	1115.0	2.06	10.96	0.002185	0.045613	240.3
13.19	1146.6	2.23	13.19	0.001996	0.047609	277.0
15.58	1140.0	2.39	15.58	0.002085	0.049694	313.5
18.13	1160.8	2.55	18.13	0.002241	0.051935	349.1
20.85	1212.8	2.72	20.85	0.002343	0.054278	384.2
23.74	1236.6	2.88	23.74	0.002379	0.056657	418.9
26.79	1353.1	3.05	26.79	0.002466	0.059122	453.1
30.00	1671.8	3.21	30.00	0.002376	0.061498	487.8

Location

Sounding:	X (m)	Y (m)
MTM/Nad83	319665	4997492

Vs30 (m/s)	487.8
Class :	C

NOTES :

- 1- The Vs values express estimated in-situ shear wave velocities; they were not corrected for the vertical effective overburden stress.
- 2- The Vs values for the first 5 meters are abnormally low. This could be related to a soil with a liquefaction potential. An adequate geotechnical assessment should be made to ensure that the site class remains C, or be re-classified as a F.

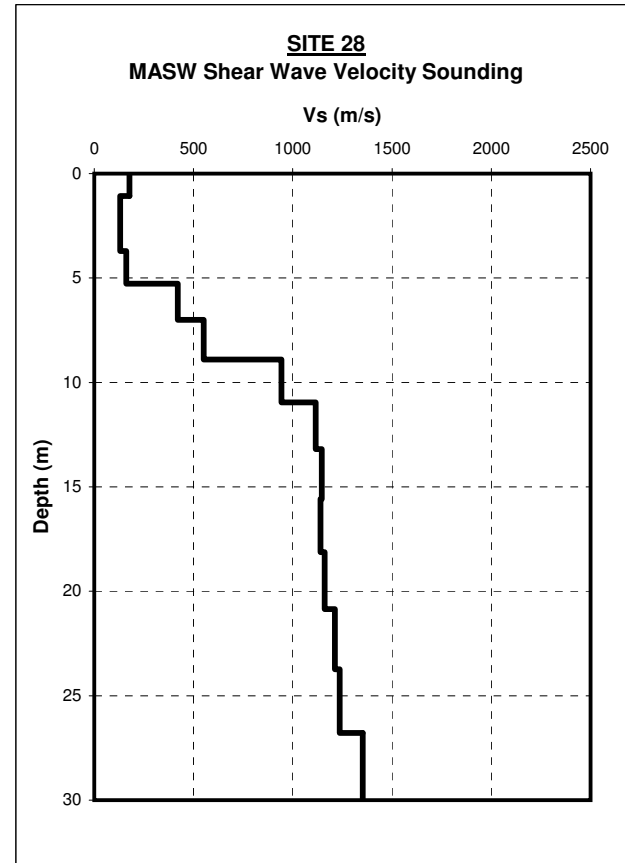

Groupe ABS / Wind Energy Converters (WEC) / Saint-Valentin, Qc

Depth (m)	Vs (m/s)	Thickness (m)	Cumulated thickness (m)	Delay for med. Vs (s)	Cumulated delay (s)	Average Vs at given depth (m/s)
0.00	93.3					
1.07	204.7	1.07	1.07	0.011483	0.011483	93.3
2.31	129.0	1.24	2.31	0.006040	0.017523	131.7
3.71	208.3	1.40	3.71	0.010863	0.028386	130.7
5.27	510.6	1.57	5.27	0.007517	0.035903	146.9
7.01	704.0	1.73	7.01	0.003390	0.039293	178.3
8.90	778.8	1.90	8.90	0.002693	0.041986	212.0
10.96	1383.9	2.06	10.96	0.002646	0.044631	245.6
13.19	1416.3	2.23	13.19	0.001608	0.046239	285.2
15.58	1599.9	2.39	15.58	0.001688	0.047927	325.0
18.13	1605.6	2.55	18.13	0.001597	0.049524	366.1
20.85	1614.0	2.72	20.85	0.001694	0.051218	407.1
23.74	1623.7	2.88	23.74	0.001787	0.053005	447.8
26.79	1648.4	3.05	26.79	0.001878	0.054883	488.1
30.00	2254.3	3.21	30.00	0.001950	0.056833	527.9

Location

Sounding:	X (m)	Y (m)
MTM/Nad83	319414	4997499

Vs30 (m/s)	527.9
Class :	C

NOTES :

- 1- The Vs values express estimated in-situ shear wave velocities; they were not corrected for the vertical effective overburden stress.
- 2- The Vs values for the first 4-5 meters are abnormally low. This could be related to a soil with a liquefaction potential. An adequate geotechnical assessment should be made to ensure that the site class remains C, or be re-classified as a F.

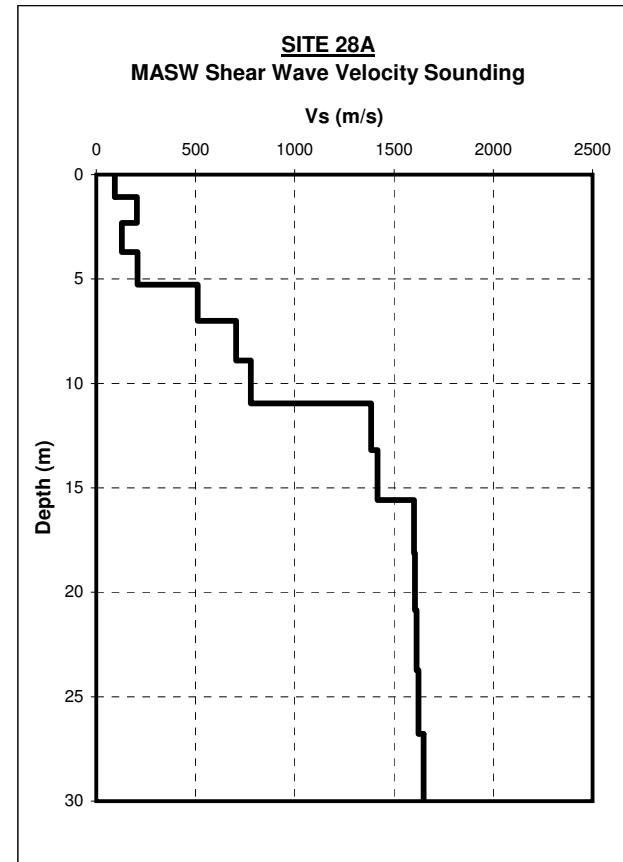

Groupe ABS / Wind Energy Converters (WEC) / Saint-Valentin, Qc

Depth (m)	Vs (m/s)	Thickness (m)	Cumulated thickness (m)	Delay for med. Vs (s)	Cumulated delay (s)	Average Vs at given depth (m/s)
0.00	240.4					
1.07	184.6	1.07	1.07	0.004456	0.004456	240.4
2.31	372.4	1.24	2.31	0.006698	0.011154	206.9
3.71	529.1	1.40	3.71	0.003763	0.014917	248.6
5.27	519.6	1.57	5.27	0.002960	0.017877	295.1
7.01	867.3	1.73	7.01	0.003331	0.021208	330.3
8.90	1135.6	1.90	8.90	0.002186	0.023393	380.5
10.96	1164.9	2.06	10.96	0.001814	0.025208	434.8
13.19	1307.3	2.23	13.19	0.001910	0.027118	486.3
15.58	1339.0	2.39	15.58	0.001828	0.028946	538.1
18.13	1355.7	2.55	18.13	0.001908	0.030854	587.7
20.85	1389.3	2.72	20.85	0.002006	0.032860	634.6
23.74	1415.2	2.88	23.74	0.002076	0.034937	679.4
26.79	1632.7	3.05	26.79	0.002155	0.037092	722.2
30.00	1737.2	3.21	30.00	0.001969	0.039060	768.0

Location

Sounding:	X (m)	Y (m)
MTM/Nad83	319828	5002096

Vs30 (m/s)	768.0
Class :	B

NOTES :

- 1- The Vs values express estimated in-situ shear wave velocities; they were not corrected for the vertical effective overburden stress.
- 2- The site class B can be considered only if there is less than 3 meters of overburden between the rock surface and the bottom of the mat foundation (cf. CNBC 2005 ; Commentary J ; Sentence 100).

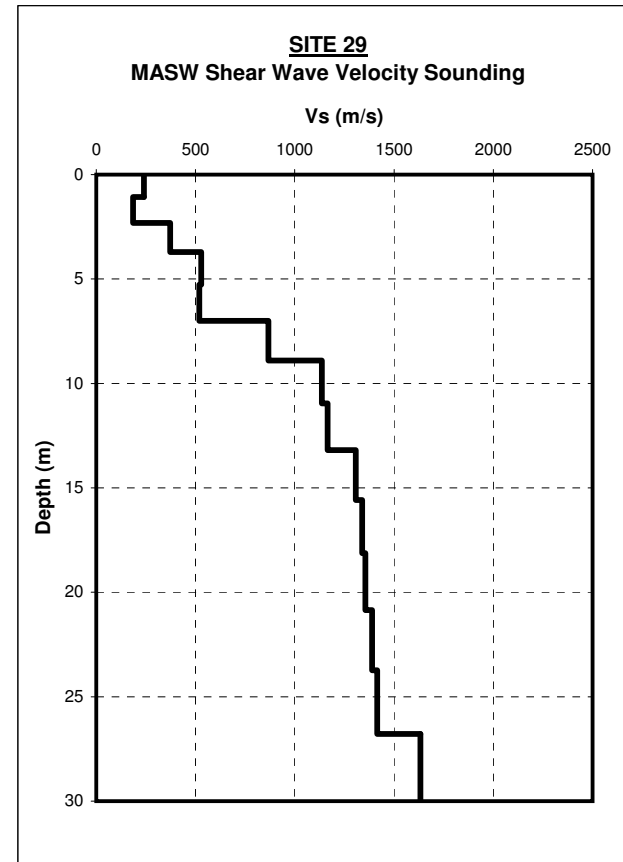

Groupe ABS / Wind Energy Converters (WEC) / Saint-Valentin, Qc

Depth (m)	Vs (m/s)	Thickness (m)	Cumulated thickness (m)	Delay for med. Vs (s)	Cumulated delay (s)	Average Vs at given depth (m/s)
0.00	170.6					
1.07	240.6	1.07	1.07	0.006281	0.006281	170.6
2.31	233.5	1.24	2.31	0.005137	0.011418	202.1
3.71	1055.2	1.40	3.71	0.006000	0.017419	212.9
5.27	1300.4	1.57	5.27	0.001484	0.018903	279.0
7.01	1385.4	1.73	7.01	0.001331	0.020234	346.2
8.90	1480.9	1.90	8.90	0.001368	0.021602	412.1
10.96	1732.5	2.06	10.96	0.001391	0.022993	476.7
13.19	1684.0	2.23	13.19	0.001284	0.024278	543.2
15.58	1635.5	2.39	15.58	0.001419	0.025697	606.2
18.13	1601.8	2.55	18.13	0.001562	0.027259	665.2
20.85	1630.6	2.72	20.85	0.001698	0.028957	720.1
23.74	1699.2	2.88	23.74	0.001769	0.030726	772.5
26.79	1935.6	3.05	26.79	0.001795	0.032521	823.7
30.00	3419.6	3.21	30.00	0.001661	0.034181	877.7

Location

Sounding:	X (m)	Y (m)
MTM/Nad83	320091	5001646

Vs30 (m/s)	877.7
Class :	B

NOTES :

- 1- The Vs values express estimated in-situ shear wave velocities; they were not corrected for the vertical effective overburden stress.
- 2- The site class B can be considered only if there is less than 3 meters of overburden between the rock surface and the bottom of the mat foundation (cf. CNBC 2005 ; Commentary J ; Sentence 100). As 10BH-30 shows, the bedrock is at 6.5 meters deep, the class C should be considered.

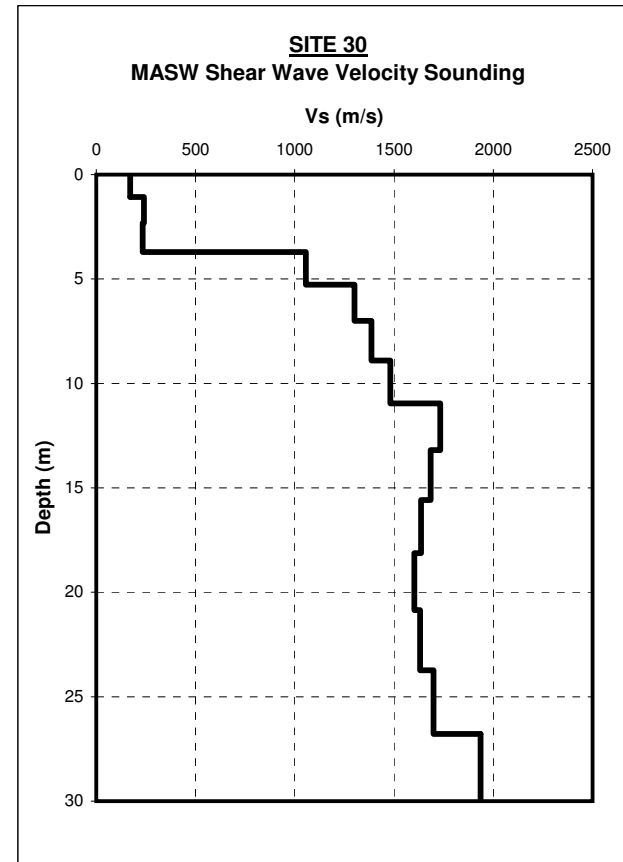

Groupe ABS / Wind Energy Converters (WEC) / Saint-Valentin, Qc

Depth (m)	Vs (m/s)	Thickness (m)	Cumulated thickness (m)	Delay for med. Vs (s)	Cumulated delay (s)	Average Vs at given depth (m/s)
0.00	179.1					
1.07	108.4	1.07	1.07	0.005981	0.005981	179.1
2.31	135.5	1.24	2.31	0.011408	0.017389	132.7
3.71	159.1	1.40	3.71	0.010337	0.027726	133.8
5.27	213.7	1.57	5.27	0.009840	0.037566	140.4
7.01	327.1	1.73	7.01	0.008100	0.045666	153.4
8.90	433.4	1.90	8.90	0.005794	0.051461	173.0
10.96	782.7	2.06	10.96	0.004754	0.056215	195.0
13.19	1185.5	2.23	13.19	0.002843	0.059058	223.3
15.58	1261.5	2.39	15.58	0.002016	0.061074	255.0
18.13	1276.8	2.55	18.13	0.002025	0.063100	287.4
20.85	1316.2	2.72	20.85	0.002130	0.065230	319.7
23.74	1354.6	2.88	23.74	0.002192	0.067421	352.1
26.79	1391.3	3.05	26.79	0.002251	0.069673	384.5
30.00	1451.5	3.21	30.00	0.002310	0.071983	416.8

Location

Sounding:	X (m)	Y (m)
MTM/Nad83	320095	4997479

Vs30 (m/s)	416.8
Class :	C

NOTES :

- 1- The Vs values express estimated in-situ shear wave velocities; they were not corrected for the vertical effective overburden stress.
- 2- The Vs values for the first 4-7 meters are abnormally low. This could be related to a soil with a liquefaction potential. An adequate geotechnical assessment should be made to ensure that the site class remains C, or be re-classified as a F.

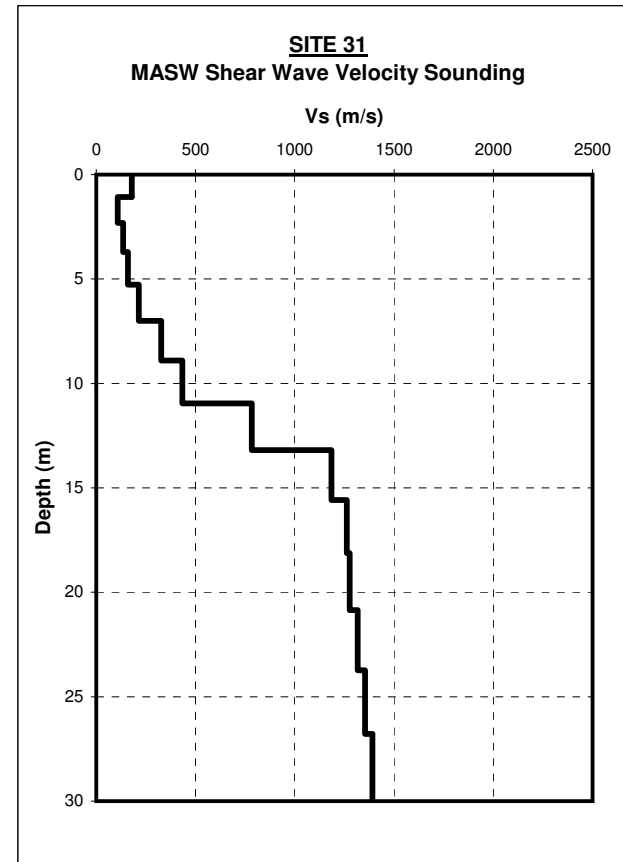

Groupe ABS / Wind Energy Converters (WEC) / Saint-Valentin, Qc

Depth (m)	Vs (m/s)	Thickness (m)	Cumulated thickness (m)	Delay for med. Vs (s)	Cumulated delay (s)	Average Vs at given depth (m/s)
0.00	154.1					
1.07	141.3	1.07	1.07	0.006953	0.006953	154.1
2.31	235.3	1.24	2.31	0.008751	0.015705	146.9
3.71	225.3	1.40	3.71	0.005956	0.021660	171.2
5.27	237.4	1.57	5.27	0.006949	0.028609	184.4
7.01	347.9	1.73	7.01	0.007290	0.035899	195.1
8.90	437.4	1.90	8.90	0.005448	0.041347	215.3
10.96	1201.9	2.06	10.96	0.004711	0.046058	238.0
13.19	1245.1	2.23	13.19	0.001851	0.047910	275.2
15.58	1271.9	2.39	15.58	0.001920	0.049830	312.6
18.13	1302.3	2.55	18.13	0.002009	0.051838	349.8
20.85	1327.2	2.72	20.85	0.002088	0.053927	386.7
23.74	1356.1	2.88	23.74	0.002173	0.056100	423.1
26.79	1384.4	3.05	26.79	0.002249	0.058349	459.1
30.00	1444.1	3.21	30.00	0.002322	0.060671	494.5

Location

Sounding:	X (m)	Y (m)
MTM/Nad83	319926	4997484

Vs30 (m/s)	494.5
Class :	C

NOTES :

- 1- The Vs values express estimated in-situ shear wave velocities; they were not corrected for the vertical effective overburden stress.
- 2- The Vs values for the first 2-4 meters are abnormally low. This could be related to a soil with a liquefaction potential. An adequate geotechnical assessment should be made to ensure that the site class remains C, or be re-classified as a F.

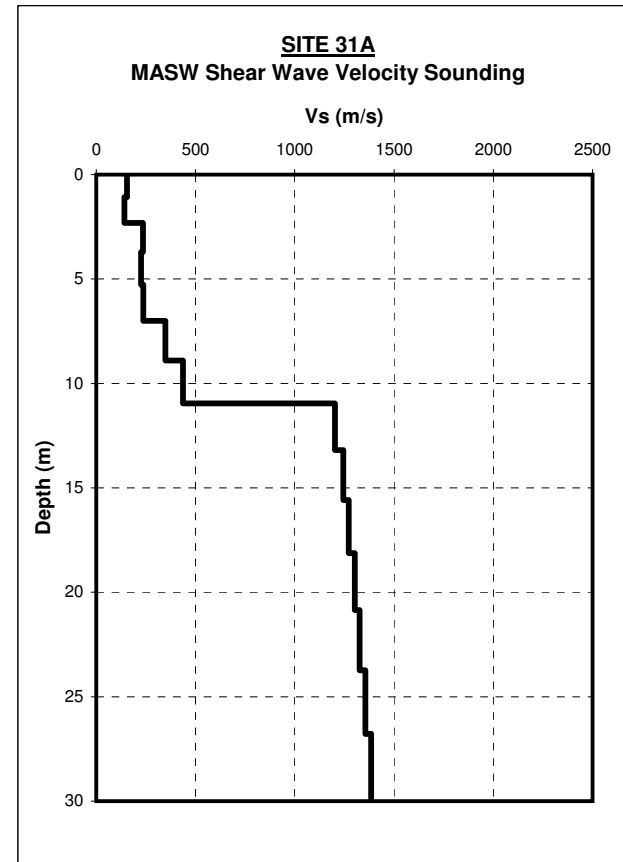

Groupe ABS / Wind Energy Converters (WEC) / Saint-Valentin, Qc

Depth (m)	Vs (m/s)	Thickness (m)	Cumulated thickness (m)	Delay for med. Vs (s)	Cumulated delay (s)	Average Vs at given depth (m/s)
0.00	257.5506					
1.07	201.0363	1.07	1.07	0.004160	0.004160	257.6
2.31	273.5122	1.24	2.31	0.006149	0.010310	223.8
3.71	455.2144	1.40	3.71	0.005123	0.015432	240.3
5.27	770.9427	1.57	5.27	0.003440	0.018872	279.5
7.01	1383.861	1.73	7.01	0.002245	0.021117	331.7
8.90	1520.026	1.90	8.90	0.001370	0.022487	395.8
10.96	1539.346	2.06	10.96	0.001356	0.023842	459.7
13.19	1569.83	2.23	13.19	0.001446	0.025288	521.5
15.58	1593.021	2.39	15.58	0.001523	0.026811	581.0
18.13	1628.209	2.55	18.13	0.001604	0.028414	638.1
20.85	1656.517	2.72	20.85	0.001670	0.030085	693.1
23.74	1683.846	2.88	23.74	0.001741	0.031826	745.8
26.79	1707.615	3.05	26.79	0.001811	0.033637	796.3
30.00	1738.884	3.21	30.00	0.001882	0.035520	844.6

Location

Sounding:	X (m)	Y (m)
MTM/Nad83	320241	5002214

Vs30 (m/s)	844.6
Class :	B

NOTES :

- 1- The Vs values express estimated in-situ shear wave velocities; they were not corrected for the vertical effective overburden stress.
- 2- The Vs sounding was resolved from the surface to 26 meters deep. The lower portion up to 30 meters deep was extrapolated for the calculation needs.
- 3- The site class B can be considered only if there is less than 3 meters of overburden between the rock surface and the bottom of the mat foundation (cf. CNBC 2005 ; Commentary J ; Sentence 100). As 10BH-32 shows, the bedrock is at 6.4 meters deep, the class C should be considered.

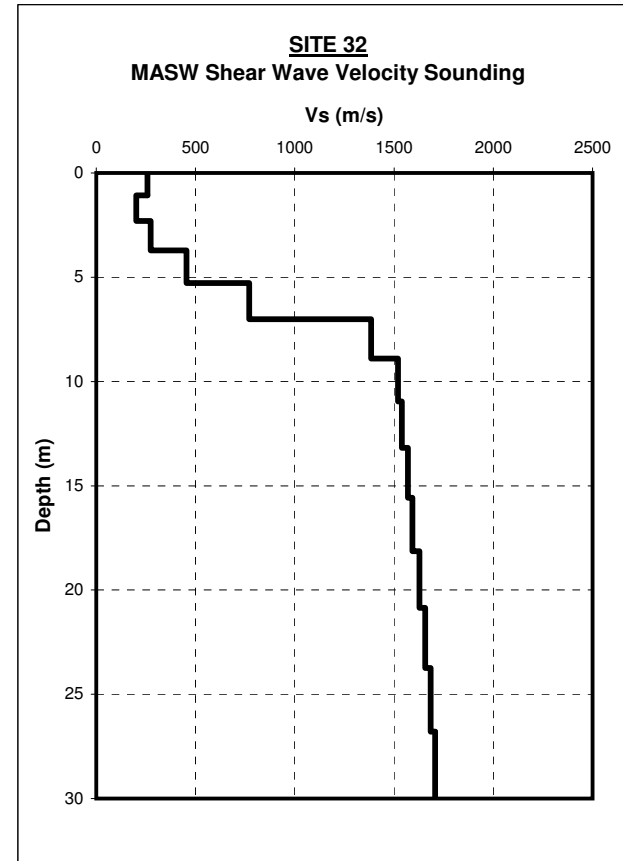

Groupe ABS / Wind Energy Converters (WEC) / Saint-Valentin, Qc

Depth (m)	Vs (m/s)	Thickness (m)	Cumulated thickness (m)	Delay for med. Vs (s)	Cumulated delay (s)	Average Vs at given depth (m/s)
0.00	230.8					
1.07	239.7	1.07	1.07	0.004642	0.004642	230.8
2.31	392.9	1.24	2.31	0.005159	0.009801	235.5
3.71	385.5	1.40	3.71	0.003566	0.013367	277.5
5.27	784.2	1.57	5.27	0.004062	0.017429	302.6
7.01	985.2	1.73	7.01	0.002207	0.019636	356.8
8.90	1226.4	1.90	8.90	0.001924	0.021560	412.8
10.96	1340.3	2.06	10.96	0.001680	0.023240	471.7
13.19	1378.3	2.23	13.19	0.001660	0.024901	529.6
15.58	1410.7	2.39	15.58	0.001734	0.026635	584.8
18.13	1526.8	2.55	18.13	0.001811	0.028446	637.4
20.85	1630.8	2.72	20.85	0.001781	0.030227	689.8
23.74	1737.0	2.88	23.74	0.001769	0.031996	741.8
26.79	2102.6	3.05	26.79	0.001756	0.033752	793.6
30.00	2288.3	3.21	30.00	0.001529	0.035280	850.3

Location

Sounding:	X (m)	Y (m)
MTM/Nad83	319415	5002922

Vs30 (m/s)	850.3
Class :	B

NOTES :

- 1- The Vs values express estimated in-situ shear wave velocities; they were not corrected for the vertical effective overburden stress.
- 2- The site class B can be considered only if there is less than 3 meters of overburden between the rock surface and the bottom of the mat foundation (cf. CNBC 2005 ; Commentary J ; Sentence 100). As 10BH-34 shows, the bedrock is at 5.1 meters deep, the class C should be considered.

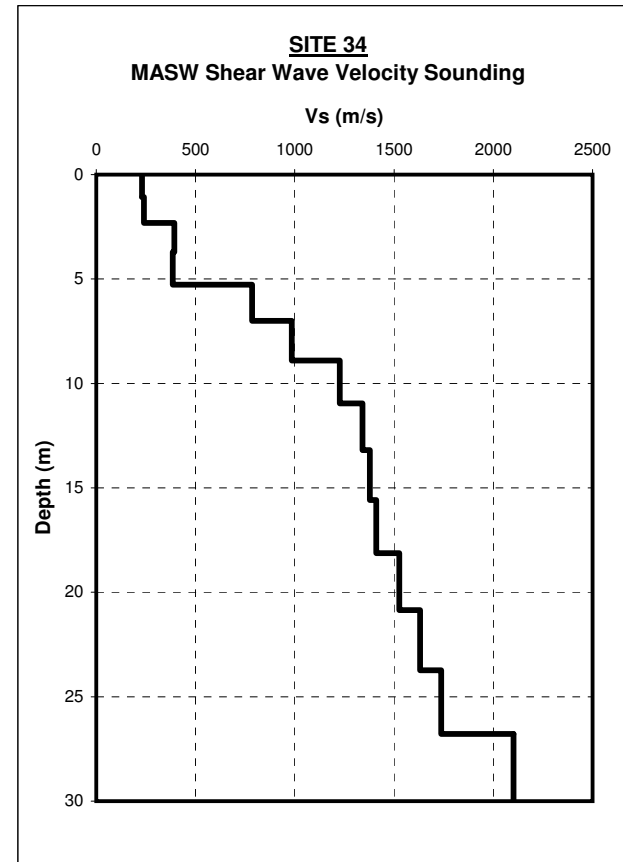

Groupe ABS / Wind Energy Converters (WEC) / Saint-Valentin, Qc

Depth (m)	Vs (m/s)	Thickness (m)	Cumulated thickness (m)	Delay for med. Vs (s)	Cumulated delay (s)	Average Vs at given depth (m/s)
0.00	262.7					
1.07	237.5	1.07	1.07	0.004079	0.004079	262.7
2.31	334.5	1.24	2.31	0.005206	0.009285	248.6
3.71	308.7	1.40	3.71	0.004189	0.013473	275.3
5.27	382.7	1.57	5.27	0.005073	0.018546	284.4
7.01	554.0	1.73	7.01	0.004522	0.023068	303.7
8.90	706.1	1.90	8.90	0.003422	0.026490	336.0
10.96	1497.9	2.06	10.96	0.002918	0.029408	372.7
13.19	1513.0	2.23	13.19	0.001486	0.030894	426.8
15.58	1521.8	2.39	15.58	0.001580	0.032473	479.7
18.13	1525.0	2.55	18.13	0.001679	0.034152	530.9
20.85	1547.1	2.72	20.85	0.001783	0.035936	580.2
23.74	1569.3	2.88	23.74	0.001864	0.037800	627.9
26.79	1676.0	3.05	26.79	0.001943	0.039743	674.0
30.00	2150.4	3.21	30.00	0.001918	0.041661	720.1

Location

Sounding:	X (m)	Y (m)
MTM/Nad83	319169	5002673

Vs30 (m/s)	720.1
Class :	C

NOTES :

1- The Vs values express estimated in-situ shear wave velocities; they were not corrected for the vertical effective overburden stress.

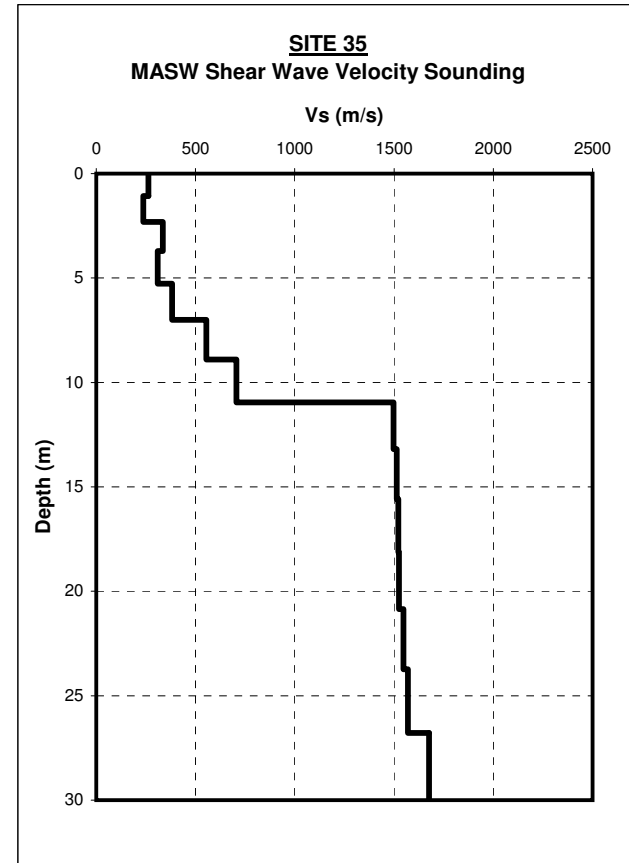

Groupe ABS / Wind Energy Converters (WEC) / Saint-Valentin, Qc

Depth (m)	Vs (m/s)	Thickness (m)	Cumulated thickness (m)	Delay for med. Vs (s)	Cumulated delay (s)	Average Vs at given depth (m/s)
0.00	292.2					
1.07	203.0	1.07	1.07	0.003666	0.003666	292.2
2.31	204.9	1.24	2.31	0.006090	0.009756	236.5
3.71	805.7	1.40	3.71	0.006839	0.016595	223.5
5.27	1466.0	1.57	5.27	0.001944	0.018539	284.5
7.01	1584.1	1.73	7.01	0.001181	0.019720	355.3
8.90	1602.7	1.90	8.90	0.001197	0.020916	425.6
10.96	1662.1	2.06	10.96	0.001286	0.022202	493.7
13.19	1677.1	2.23	13.19	0.001339	0.023541	560.2
15.58	1677.1	2.39	15.58	0.001425	0.024966	623.9
18.13	1677.1	2.55	18.13	0.001523	0.026489	684.5
20.85	1832.1	2.72	20.85	0.001622	0.028111	741.8
23.74	1999.8	2.88	23.74	0.001574	0.029685	799.6
26.79	1999.8	3.05	26.79	0.001525	0.031210	858.2
30.00	1999.8	3.21	30.00	0.001607	0.032818	914.1

Location

Sounding:	X (m)	Y (m)
MTM/Nad83	318483	5001515

Vs30 (m/s)	914.1
Class :	B

NOTES :

- 1- The Vs values express estimated in-situ shear wave velocities; they were not corrected for the vertical effective overburden stress.
- 2- The site class B can be considered only if there is less than 3 meters of overburden between the rock surface and the bottom of the mat foundation (cf. CNBC 2005 ; Commentary J ; Sentence 100). As 10BH-37 shows, the bedrock is at 7.8 meters deep, the class C should be considered.

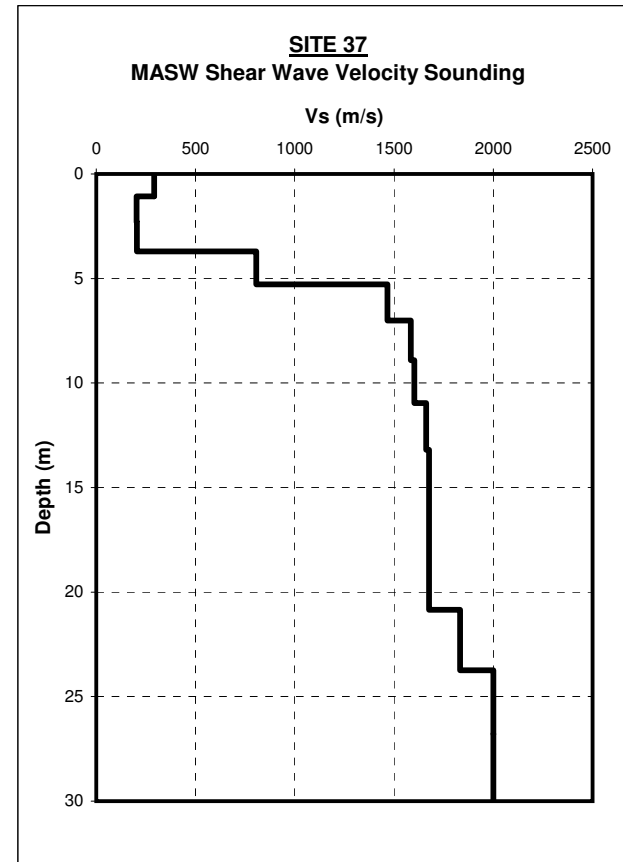

Appendix F

Rock samples photos



Photography 1 : 10BH-30



Photography 2 : 10BH-32



Photography 3 : 10BH-32



Photography 4 : 10BH-26



Photography 5 : 10BH-26



Photography 6 : 10BH-16



Photography 7 : 10BH-16



Photography 8 : 10BH-05



Photography 9 : 10BH-05



Photography 10 : 10BH-09



Photography 11 : 10BH-09



Photography 12 : 10BH-07



Photography 13 : 10BH-07



Photography 14 : 10BH-18



Photography 15 : 10BH-18



Photography 16 : 10BH-21



Photography 17 : 10BH-21



Photography 18 : 10BH-20



Photography 19 : 10BH-29



Photography 20 : 10BH-29



Photography 21 : 10BH-04



Photography 22 : 10BH-04



Photography 23 : 10BH-06



Photography 24 : 10BH-06



Photography 25 : 10BH-08



Photography 26 : 10BH-11



Photography 27 : 10BH-11



Photography 28 : 10BH-12



Photography 29 : 10BH-12



Photography 30 : 10BH-14



Photography 31 : 10BH-14



Photography 32 : 10BH-25



Photography 33 : 10BH-25



Photography 34 : 10BH-34



Photography 35 : 10BH-34



Photography 36 : 10BH-35



Photography 37 : 10BH-35



Photography 38 : 10BH-22



Photography 39 : 10BH-22



Photography 40 : 10BH-22



Photography 41 : 10BH-31



Photography 42 : 10BH-31



Photography 43 : 10BH-31A



Photography 44 : 10BH-31A



Photography 45 : 10BH-28



Photography 46 : 10BH-28



Photography 47 : 10BH-37



Photography 48 : 10BH-37



Photography 49 : 10BH-27



Photography 50 : 10BH-27



Photography 51 : 10BH-23



Photography 52 : 10BH-23

Appendix G

Miscellaneous documents

TEST PIT AND BORING LOG REPORT EXPLANATORY NOTE

Soil description

Each layer of subsoil is described following the terminology listed below. Granular soil compactness is defined by the standard penetration index value "N" and cohesive soil consistency is defined by the undisturbed shear strength (Cu).

Depth, elevation and scale

The depth of the various stratigraphic layers is based upon the ground surface of the corresponding test pit or borehole. All elevations can be arbitrary or geodesic, the reference level always being indicated. The elevation and depth scale is always indicated in meters.

Soil classification

Clay		< 0,002 mm
Silt		0,002 - 0,08 mm
Sand	fine	0,08 - 0,4 mm
	medium	0,4 - 1,0 mm
	coarse	1,0 - 5,0 mm
Gravel	fine	5,0 - 10,0 mm
	coarse	10,0 - 80,0 mm
Cobbles		80,0 - 300,0 mm
Boulders		> 300,0 mm

Terminology and proportions

" traces "	< 10%
" some "	10 - 20%
Adjective (sandy...)	20 - 35%
" and "	> 35%

Granular soils







Compactness	Standard penetration index " N " (blow counts / 300 mm)
Very loose	< 4
Loose	4 - 10
Compact	10 - 30
Dense	30 - 50
Very dense	> 50

Cohesive soils

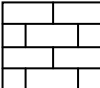
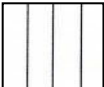

Consistency	Shear strength " Cu " (kPa)
Very soft	< 12
Soft	12 - 25
Firm	25 - 50
Stiff	50 - 100
Very stiff	100 - 200
Hard	> 200

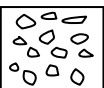
Plasticity index	Liquid limit " W _L "	Sensitivity S _t = Cu/Cu _R
Low	< 30%	< 2
Medium	30 - 50%	2 - 4
High	> 50%	4 - 8
		8 - 16
		> 16

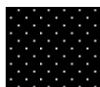
Stratigraphy symbols

Clay		Rock	
Silt		Organic soil	
Sand		Concrete	
Gravel		Crushed stone	
Cobbles and Boulders		Asphalt	

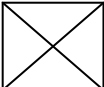
Soil state

Disturbed		Intact	
-----------	--	--------	---

Groundwater symbols

Water infiltration		Groundwater table	
--------------------	---	-------------------	---

ABBREVIATIONS

Samples		
Split spoon		CF
Thin wall tube (Shelby)		TM
Helical auger		TR
Coring drill		CR
In situ and laboratory tests		
Hydrometer test		S
Grain size analysis		G
Water content		W
Unit weight		γ
Consolidation		C
Swedish fall cone		CS
Hydraulic conductivity		K
Refusal		R

Plasticity index	IP
Liquid limit	W _L
Plastic limit	W _P
Atterberg limit	A

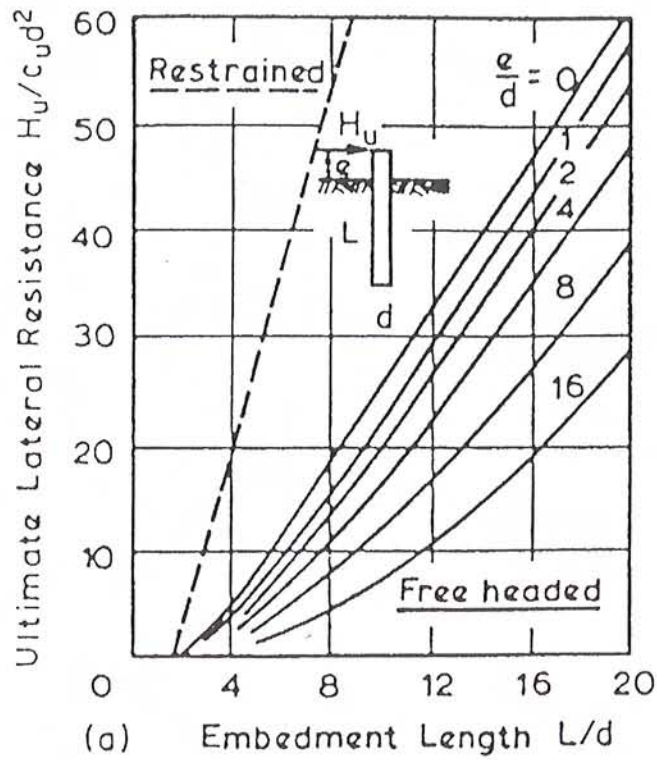

a) Short Pile

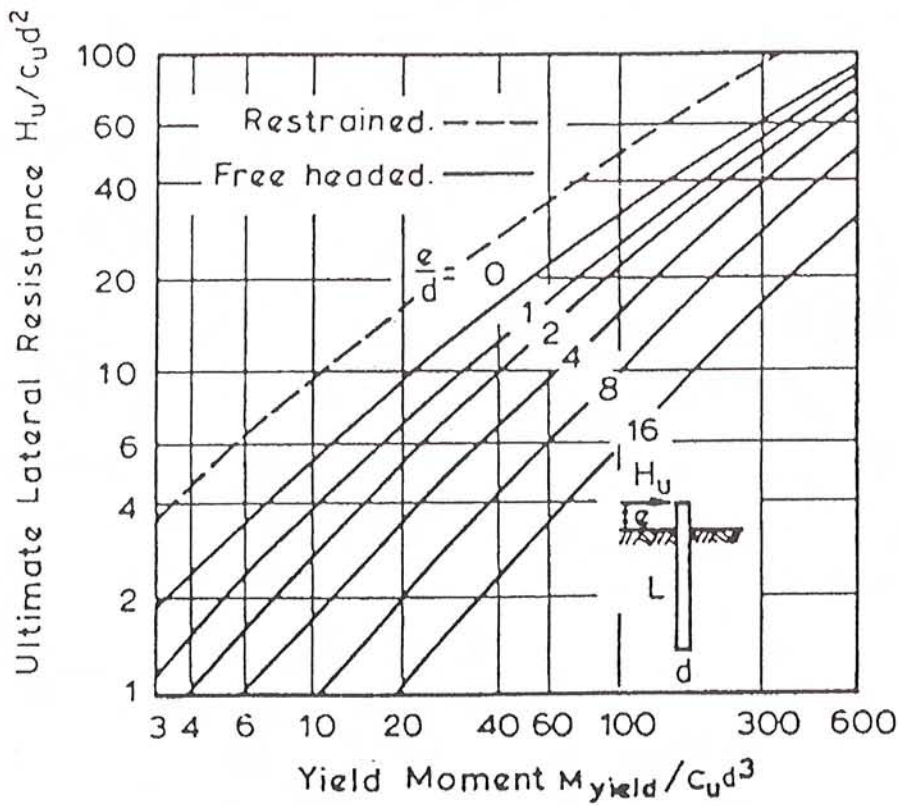
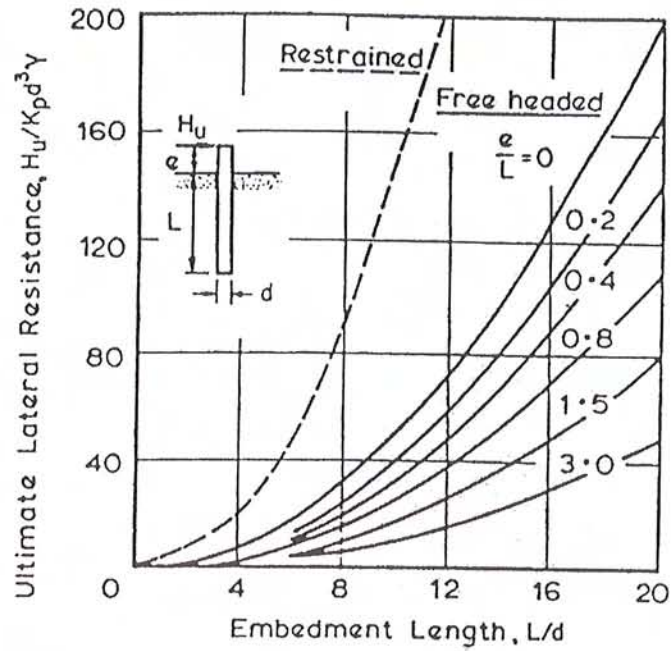
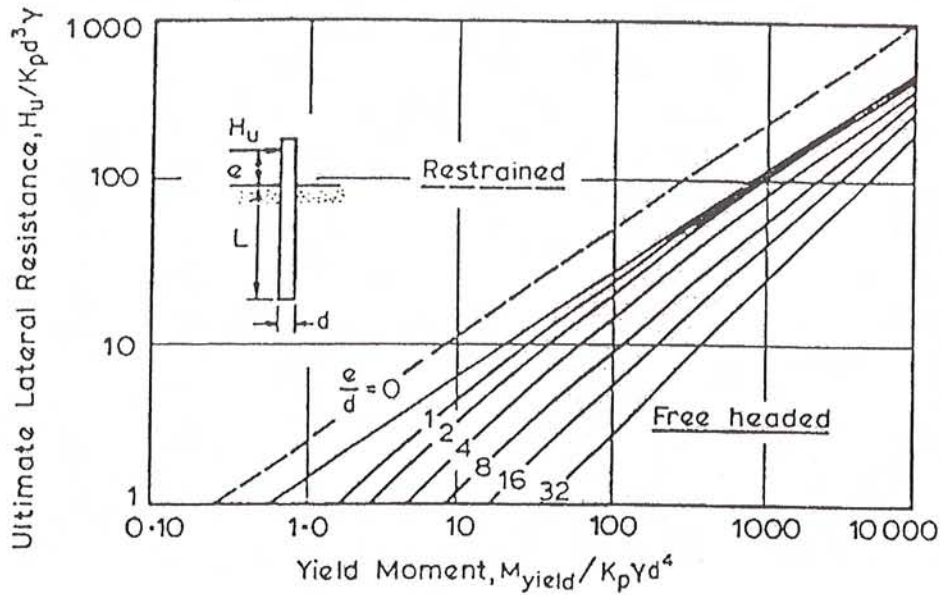

FIGURE 18.10 Ultimate lateral resistance of piles in cohesive soils (after Broms, 1964a)



a) Short Pile



b) Long Pile

FIGURE 18.9 Ultimate lateral resistance of piles in cohesionless soils (after Broms, 1964b)

Figure 37-1 Unified soil classification system.

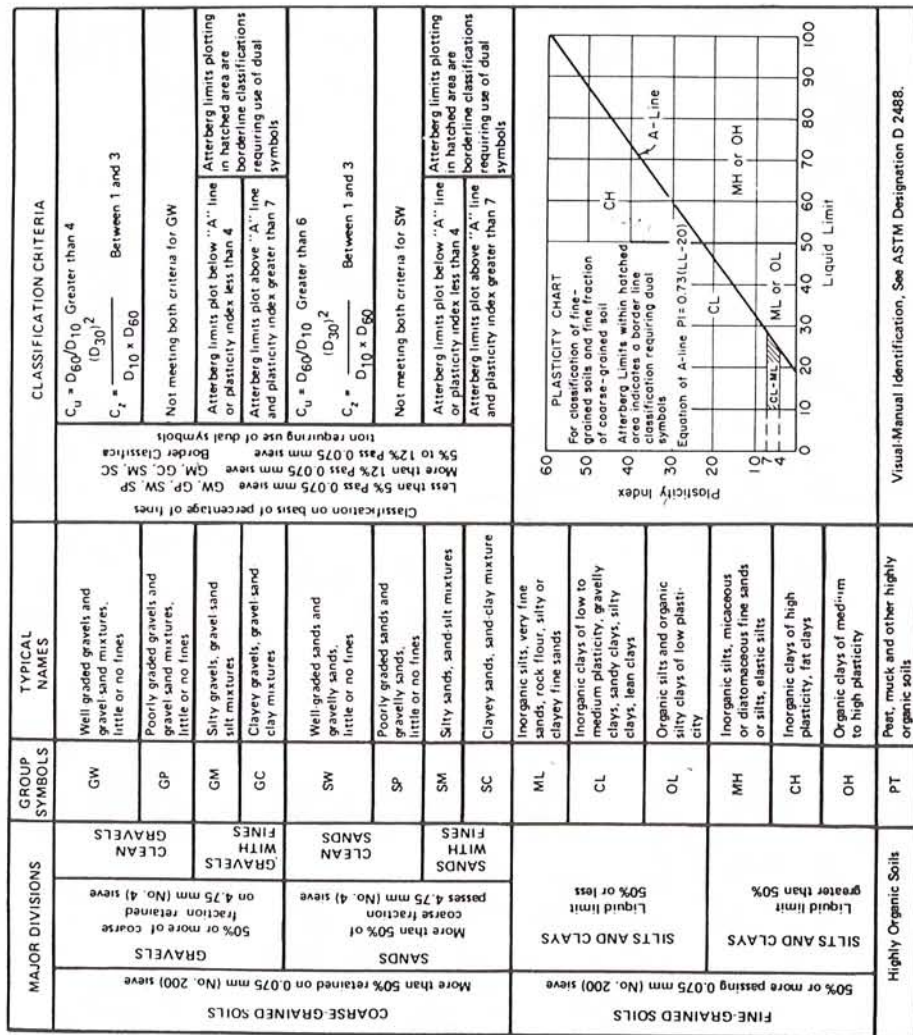

Fundamentdatenblatt
für geotechnische Nachweise
Foundation data sheet
for geotechnical calculations

21. NOV. 2006

Reviewed by comparing calculation
8000169412/R E 1

Reviewed

Hamburg,

Chr. Hering
Expert of

TÜVNORD SysTec GmbH & Co.KG

Turmtyp: **E-82/BF/83/17/01**
tower type:

Typenklasse: Windzone 4, GK I (DIBt-Richtlinie)
type class: WTGS class II A (IEC-/NVN-/EN-Richtlinie)

Fundamenttyp: **Tiefgründung - Kreisringfundament**
mit Auftrieb - Ø 15,60m - 36 Pfähle
Auftragsnr.: 2790-06 vom 23.05.2006

foundation type: **pile foundation - circular ringfoundation**
with buoyancy - Ø 15,60m - 36 piles
order number: 2790-06 dated 23.05.2006

Datum: 04.09.2006
date: Rev. 1.1 / 31.10.2006 OL

ENERCON GmbH

Dreekamp 5
D - 26605 Aurich / Germany
www.enercon.de

Author: Dipl.-Ing. O. Lehmann
Approved: Dipl.-Ing. (FH) M. Schacknies





Document information:		
Author/ date:	OL / 04.09.2006	
Department:	WRD-K	Translator / date:
Approved / date:	MS / 04.09.2006	Revisor / date: OL / 31.10.2006
Revision / date:	1.1 / 31.10.2006	Reference: WRD-04-FDB_E-82_BF_83_17_01_TGmA_Rev1_1-ger.doc

- Pfahlkräfte für geotechnische Nachweise**
Loads of the pile for geotechnical calculations

maximale Druckkraft <i>maximum compressive force</i>	- 1.275 kN
maximale Zugkraft <i>maximum tensile force</i>	324 kN

alle Lasten mit Teilsicherheitsbeiwert $\gamma_F = 1,0$
 all loads with partial safety factor $\gamma_F = 1,0$

- Pfahlgeometrie / pile geometry**

Pfahllänge <i>length of the piles</i>		16,00 m
Pfahlanzahl <i>number of piles</i>		Pfahlneigung <i>pile inclination</i>
Total	24	4:1 nach außen 4:1 outwards
	12	10:1 nach innen 10:1 inwards
Pfahlquerschnitt <i>pile cross section</i>	Quadrat <i>quadrat</i>	45 cm/45 cm

Die Pfähle müssen wegen der Zugbeanspruchung mindestens 5,00 m in den ausreichend tragfähigen Baugrund einbinden.
 In consequence of tension in the piles, they must bind 5,00 m into the better ground.

- Drehfedersteifigkeit / rocking spring stiffness**

Für die Fundamenteinspannung zwischen Fundament und Baugrund ist eine Mindestdrehfedersteifigkeit von $k_{\phi, \text{dyn}} = 100.000 \text{ MNm/rad}$ (**dynamische Bodenkennwerte**) bzw. $k_{\phi, \text{stat}} = 25.000 \text{ MNm/rad}$ (**statische Bodenkennwerte**) für das Gesamtsystem (Turm und Gründung inkl. Pfahlssystem) einzuhalten.

Eine dynamische Mindestdrehfedersteifigkeit des Pfahlsystems von $k_{\phi, \text{dyn}} = 300.000 \text{ MNm/rad}$ (**dynamische Bodenkennwerte**) ist einzuhalten.

The minimum value of rocking spring stiffness for clamping between foundation and soil must be $k_{\phi, \text{dyn}} = 100.000 \text{ MNm/rad}$ (dynamic soil parameter) as well as $k_{\phi, \text{stat}} = 25.000 \text{ MNm/rad}$ (static soil parameter) for the total system (tower and foundation incl. piles system).

The minimum value of rocking spring stiffness for the piles system must be $k_{\phi, \text{dyn}} = 300.000 \text{ MNm/rad}$ (dynamic soil parameter).

- Zulässige Schiefstellung / permissible tilting**

Maximal zulässige Schiefstellung infolge Baugrundsetzung in 20 Jahren bezogen auf den Pfahlkreisdurchmesser.

Maximum allowed tilting due to settlement of the foundation soil in 20 years relating to the pile circle diameter.

$$\Delta s \leq 40 \text{ mm}$$

 21. NOV. 2006

Document information:			
Author / date:	OL / 04.09.2006	Translator / date:	-
Department:	WRD-K	Revisor / date:	OL / 31.10.2006
Approved / date:	MS / 04.09.2006	Reference:	WRD-04-FDB_E-82_BF_83_17_01_TGmA_Rev1_1-ger.doc
Revision / date:	1.1 / 31.10.2006		

• **Lastangaben für den inneren Tragsicherheitsnachweis der Pfähle**
Loads for the dimensioning for the internal force of the piles

maximale Druckkraft <i>maximum compressive force</i> (Pfahloberkante / top of pile)	- 1.577 kN	Einspannmoment in Platte <i>Clamping moment into plate</i>	40,0 kNm
maximale Zugkraft <i>maximum tensile force</i> (Pfahloberkante / top of pile)	440 kN	Max. Moment im Verlauf des Pfahls <i>Max. moment in middle of the pile</i>	27,0 kNm

alle Lasten mit Teilsicherheitsbeiwerten
all loads with partial safety factors

Folgende seitliche Bettung des Pfahls ist einzuhalten (Tiefe bezogen auf UK Fundament)..
The following bedding modulus of the pile has to be considered (depth relates to the bottom of the foundation).

Tiefe <i>depth</i>	$E_{s, stat}$
0,00 m – 4,50 m	0,0 MN/m ²
4,50 m – 7,50 m	1,0 MN/m ²
7,50 m – 10,50 m	2,0 MN/m ²
10,50 m – 16,00 m	4,0 MN/m ²

• **Lasten an der Fundamentunterkante**

(inkl. Fundamenteigengewicht $\gamma = 25 \text{ kN/m}^3$ und Bodenauflast $\gamma = 18 \text{ kN/m}^3$ im Trockenzustand)
Loads at the bottom of foundation
(incl. foundation dead weight $\gamma = 25 \text{ kN/m}^3$ and soil weight $\gamma = 18 \text{ kN/m}^3$ for dry conditions)

Lastfall <i>load case</i>	F_{xy} [kN]	F_z [kN]	M_{xy} [kNm]	M_z [kNm]
DLC 1.0	570	-13.787 mit Auftrieb / <i>with buoyancy</i>	37.024	1.750
		-19.425 ohne Auftrieb / <i>without buoyancy</i>		
DLC 6.2	850	-13.787 mit Auftrieb / <i>with buoyancy</i>	61.370	1.860
		-19.425 ohne Auftrieb / <i>without buoyancy</i>		

alle Lasten mit Teilsicherheitsbeiwert $\gamma_F = 1,0$
all loads with partial safety factor $\gamma_F = 1,0$

Lastfall <i>load case</i> ($\gamma_{aero}/\gamma_{masse}$)	F_{xy} [kN]	F_z [kN]	M_{xy} [kNm]	M_z [kNm]
DLC 6.2 (1.10/1.35) ohne Auftrieb <i>without buoyancy</i>	1.070	-25.934	68.274	1.640
DLC 6.2 (1.10/1.00) mit Auftrieb <i>with buoyancy</i>	1.070	-13.787	68.274	1.640

alle Lasten mit Teilsicherheitsbeiwerten
all loads with partial safety factors

Document information:

Author/ date: OL / 04.09.2006
 Department: WRD-K
 Approved / date: MS / 04.09.2006
 Revision / date: 1.1 / 31.10.2006

Translator / date:
 Revisor / date:
 Reference:

OL / 31.10.2006
 WRD-04-FDB_E-82_BF_83_17_01_TGmA_Rev1_1-ger.doc

TIV NORD
 21. NOV. 2006

Fundamentgeometrie / geometry of foundation

Außendurchmesser <i>outer diameter</i>	da	15,60 m
Innendurchmesser <i>inner diameter</i>	di	6,90 m
Sockeldurchmesser, außen <i>base diameter, outside</i>	dso _a	8,70 m
Sockeldurchmesser, innen <i>base diameter, inside</i>	dso _i	4,80 m
Pfahlkreisdurchmesser <i>diameter of the pile circle</i>	dp	14,80 m
Fundamenthöhe <i>foundation height</i>	hges	3,20 m
Differenz Fundamentoberkante - GOK <i>difference top of foundation – top ground surface</i>	hgok	0,20 m
Betongüte und Volumen <i>Concrete and quantity</i>	C 30/37	440 m ³
Betonstahl und Gewicht <i>Concrete steel and weight</i>	BSt 500 S (A)	40,8 t

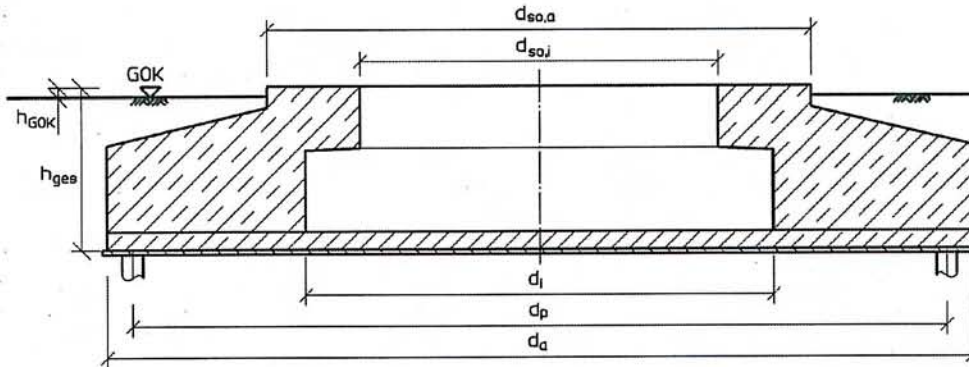

Bemerkungen / remarks

- Die angegebenen Lasten sind ausschließlich für geotechnische Nachweise zu verwenden.
The stated loads are only used for geotechnical calculations.
- Dieses Dokument wurde auf Anfrage bzw. für einen bestimmten Auftrag verschickt. Der Empfänger wurde nicht registriert! Der Empfänger wird bei Änderung nicht automatisch informiert!
This document has been sent on request on a certain order. The receiver has not been registered! The receiver will not be informed automatically in case of alterations!
- Weitergabe und Kopien an Dritte sind nur mit schriftlicher Zustimmung der ENERCON-Konstruktionsabteilung erlaubt.
Circulation of the data or copies are only enabled by written agreement from ENERCON design department.

Document information:		
Author / date:	OL / 04.09.2006	Translator / date:
Department:	WRD-K	Revisor / date:
Approved / date:	MS / 04.09.2006	Reference:
Revision / date:	1.1 / 31.10.2006	WRD-04-FDB_E-82_BF_83_17_01_TGmA_Rev1_1-genc

TUV NORD
21. NOV. 2006

Fundamentdatenblatt
für geotechnische Nachweise
Foundation data sheet
for geotechnical calculations

Turmtyp: **E-82/BF/83/17/01**
tower type:

Typenklasse: Windzone 4, GK 1 (DIBt-Richtlinie)
type class: WTGS class II A (IEC-/NVN-/EN-Richtlinie)

Fundamenttyp: **Flachgründung - Kreisringfundament
mit Auftrieb - Ø 16,80m**
Auftragsnr.: 2790-06 vom 16.05.2006

foundation type: **shallow foundation – circular ringfoundation
with buoyancy - Ø 16,80m**
order number: 2790-06 dated 16.05.2006

Datum: 04.09.2006
date: Rev. 1.0

8000169412/8 E II
Reviewed by comparing calculation

Reviewed

Hamburg

Chr. Hering

Expert of

TÜVNORD SysTec GmbH & Co.KG

ENERCON GmbH

Dreerkamp 5
D – 26605 Aurich / Germany
www.enercon.de

Author: Dipl.-Ing. O. Lehmann
Approved: Dipl.-Ing. (FH) M. Schacknies

O. Lehmann

M. Schacknies

TÜV NORD

24. NOV. 2006

Document information:		
Author / date:	OL / 04.09.2006	Translator / date:
Department:	WRD-K	Revisor / date:
Approved / date:	MS / 04.09.2006	Reference:
Revision / date:	1.0 / 04.09.2006	WRD-04-FDB_E-82_BF_83_17_01_Flma_Rev1_0-ger.doc

- Lasten an der Fundamentunterkante für geotechnische Nachweise**
 (inkl. Eigengewicht Fundament und Bodenauflast $\gamma = 18 \text{ kN/m}^3$ im Trockenzustand)
Loads at the bottom of foundation for geotechnical calculations
 (incl. dead weight foundation and soil weight $\gamma = 18 \text{ kN/m}^3$ for dry conditions)

Lastfall load case	F_{xy} [kN]	F_z [kN]	M_{xy} [kNm]	M_z [kNm]
DLC 1.0	570	-13.911 mit Auftrieb / with buoyancy	36.825	1.750
		-19.674 ohne Auftrieb / without buoyancy		
DLC 6.2	850	-13.911 mit Auftrieb / with buoyancy	61.073	1.860
		-19.674 ohne Auftrieb / without buoyancy		

alle Lasten mit Teilsicherheitsbeiwert $\gamma_F = 1,0$
 all loads with partial safety factor $\gamma_F = 1,0$

- Aufzunehmende Bodenpressung / minimum required bearing pressure**
 Der anstehende Baugrund muss mindestens eine Bodenpressung von $\sigma = 242 \text{ kN/m}^2$ aufnehmen können.
Minimum required bearing pressure is $\sigma = 242 \text{ kN/m}^2$.
- Drehfedersteifigkeit / rocking spring stiffness**
 Für die elastische Fundamenteinspannung zwischen Fundament und Baugrund sind folgende Bodenkennwerte einzuhalten.
The following soil parameters of rocking spring stiffness for clamping between foundation and soil must be meet.

Nichtbindiger Boden / cohesionless soil:	$k_{\phi, \text{dyn}} = 100.000 \text{ MNm/rad}$ $E_{\text{oed, dyn}} = 180 \text{ MN/m}^2$ ($\nu = 0,35$)
--	---

Nichtbindiger Boden / cohesionless soil:	$k_{\phi, \text{stat}} = 25.000 \text{ MNm/rad}$ $E_{\text{oed, stat}} = 45 \text{ MN/m}^2$ ($\nu = 0,35$)
--	---

Die erforderlichen dynamischen Steifemodule ($E_{\text{oed, dyn}}$) bzw. statischen Steifemodule ($E_{\text{oed, stat}}$) ergeben sich in Abhängigkeit von Fundamentgeometrie und Querdehnzahl.
The minimum values of dynamic modulus of stiffness ($E_{\text{oed, dyn}}$) respectively of static modulus of stiffness ($E_{\text{oed, stat}}$) are calculated in dependence on foundation geometry and Poisson's ratio.

Für Kreisfundamente gilt:
 For circular foundations:

$$k_{\phi} = \frac{8 \cdot G \cdot r^3}{3 \cdot (1 - \nu)}$$

G = Schubmodul / shear modulus

r = Radius / radius

$$E_{\text{oed}} = k_{\phi} \cdot \frac{3}{4} \cdot \frac{1}{r^3} \cdot \frac{(1 + \nu) \cdot (1 - \nu)^2}{1 - \nu - 2 \cdot \nu^2}$$

ν = Querdehnzahl / Poisson's ratio

- Zulässige Schiefstellung / permissible tilting**
 Maximal zulässige Schiefstellung infolge Baugrundsetzung in 20 Jahren bezogen auf den Fundamentdurchmesser.
Maximum allowed tilting due to settlement of the foundation soil in 20 years relating to the foundation diameter.

$$\Delta s \leq 40 \text{ mm}$$

Document information:		
Author / date:	OL / 04.09.2006	Translator / date:
Department:	WRD-K	Revisor / date:
Approved / date:	MS / 04.09.2006	Reference:
Revision / date:	1.0 / 04.09.2006	WRD-04-FDB_E-82_BF_83_17_01_Flma_Rev1_0-ger.doc

TUV NORD
24. NOV. 2006

Fundamentgeometrie
geometry of foundation

Außendurchmesser <i>outer diameter</i>	da	16,80 m
Innendurchmesser <i>inner diameter</i>	di	6,90 m
Sockeldurchmesser, außen <i>base diameter, outside</i>	dso _a	8,70 m
Sockeldurchmesser, innen <i>base diameter, inside</i>	dso _i	4,80 m
Fundamenthöhe <i>foundation height</i>	h _{ges}	2,85 m
Differenz Fundamentoberkante - GOK <i>difference top of foundation – top ground surface</i>	hgok	0,20 m
Fundamentsohle <i>foundation sole plate</i>	h _{Sohle}	0,30 m
Betongüte und Volumen (Fundament) <i>Concrete and quantity (foundation)</i>	C 30/37	426 m ³
Betonstahl und Gewicht (Fundament) <i>Concrete steel and weight (foundation)</i>	BSt 500 S (A)	35,8 t
Betongüte und Volumen (Fundamentsohle) <i>Concrete and quantity (foundation sole plate)</i>	C 25/30 WU	21 m ³
Betonstahl und Gewicht (Fundamentsohle) <i>Concrete steel and weight (foundation sole plate)</i>	BSt 500 S (A)	1,6 t

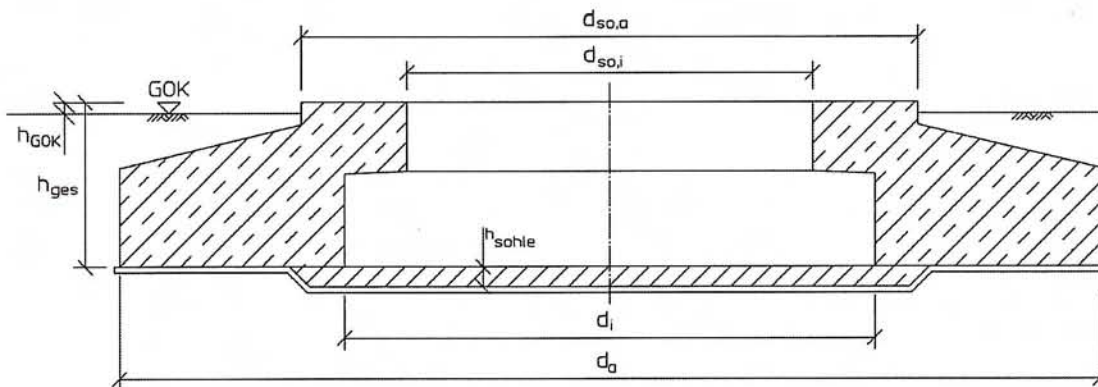
Bemerkungen / remarks

- Die angegebenen Lasten sind ausschließlich für geotechnische Nachweise zu verwenden.
The stated loads are only used for geotechnical calculations.
- Dieses Dokument wurde auf Anfrage bzw. für einen bestimmten Auftrag verschickt. Der Empfänger wurde nicht registriert! Der Empfänger wird bei Änderung nicht automatisch informiert!
This document has been sent on request on a certain order. The receiver has not been registered! The receiver will not be informed automatically in case of alterations!
- Weitergabe und Kopien an Dritte sind nur mit schriftlicher Zustimmung der ENERCON-Konstruktionsabteilung erlaubt.
Circulation of the data or copies are only enabled by written agreement from ENERCON design department.

Document information:	
Author/ date:	OL / 04.09.2006
Department:	WRD-K
Approved / date:	MS / 04.09.2006
Revision / date:	1.0 / 04.09.2006
Translator / date:	
Revisor / date:	
Reference:	WRD-04-FDB_E-82_BF_83_17_01_FimA_Rev1_0-ger.doc

TUV NORD
 24. NOV. 2006

Fundamentdatenblatt

für geotechnische Nachweise

Foundation data sheet

for geotechnical calculations

Turmtyp: **E-82/BF/83/17/01**
tower type:

Typenklasse: Windzone 4, GK I (DIBt-Richtlinie)
type class: WTGS class II A (IEC-/NVN-/EN-Richtlinie)

Fundamenttyp: **Flachgründung - Kreisringfundament**
ohne Auftrieb - Ø 14,20m
Auftragsnr.: 2790-06 vom 19.05.2006

foundation type: **shallow foundation – circular ringfoundation**
without buoyancy - Ø 14,20m
order number: 2790-06 dated 19.05.2006

Datum: 04.09.2006
date: Rev. 1.0

8000169412/8 E III
 Reviewed by comparing calculation

Reviewed

Hamburg

Chr. Hering

Expert of

TÜVNORD SysTec GmbH & Co.KG

TÜV NORD

28. NOV. 2006

ENERCON GmbH

Dreekamp 5
 D – 26605 Aurich / Germany
www.enercon.de

Author: Dipl.-Ing. O. Lehmann *Ole Lehmann*
 Approved: Dipl.-Ing. (FH) M. Schacknies *Meik Schacknies*

Document information:		
Author / date:	OL / 04.09.2006	Translator / date:
Department:	WRD-K	Revisor / date:
Approved / date:	MS / 04.09.2006	Reference:
Revision / date:	1.0 / 04.09.2006	WRD-04-FDB_E-82_BF_83_17_01_FloA_Rev1_0-ger.doc

- Lasten an der Fundamentunterkante für geotechnische Nachweise**
 (inkl. Eigengewicht Fundament und Bodenauflast $\gamma = 18 \text{ kN/m}^3$ im Trockenzustand)
Loads at the bottom of foundation for geotechnical calculations
 (incl. dead weight foundation and soil weight $\gamma = 18 \text{ kN/m}^3$ for dry conditions)

Lastfall load case	F_{xy} [kN]	F_z [kN]	M_{xy} [kNm]	M_z [kNm]
DLC 1.0	570	-15.772	36.825	1.750
DLC 6.2	850	-15.772	61.073	1.860

alle Lasten mit Teilsicherheitsbeiwert $\gamma_F = 1,0$
 all loads with partial safety factor $\gamma_F = 1,0$

- Aufzunehmende Bodenpressung / minimum required bearing pressure**
 Der anstehende Baugrund muss mindestens eine Bodenpressung von $\sigma = 412 \text{ kN/m}^2$ aufnehmen können.
Minimum required bearing pressure is $\sigma = 412 \text{ kN/m}^2$.
- Drehfedersteifigkeit / rocking spring stiffness**
 Für die elastische Fundamenteinspannung zwischen Fundament und Baugrund sind folgende Bodenkennwerte einzuhalten.
The following soil parameters of rocking spring stiffness for clamping between foundation and soil must be meet.

Nichtbindiger Boden / cohesionless soil:	$k_{\phi, \text{dyn}} \geq 100.000 \text{ MNm/rad}$ $E_{\text{oed, dyn}} = 260 \text{ MN/m}^2$ ($\nu = 0,30$)
--	--

Nichtbindiger Boden / cohesionless soil:	$k_{\phi, \text{stat}} \geq 25.000 \text{ MNm/rad}$ $E_{\text{oed, stat}} = 65 \text{ MN/m}^2$ ($\nu = 0,30$)
--	--

Die erforderlichen dynamischen Steifemodule ($E_{\text{oed, dyn}}$) bzw. statischen Steifemodule ($E_{\text{oed, stat}}$) ergeben sich in Abhängigkeit von Fundamentgeometrie und Querdehnzahl.

The minimum values of dynamic modulus of stiffness ($E_{\text{oed, dyn}}$) respectively of static modulus of stiffness ($E_{\text{oed, stat}}$) are calculated in dependence on foundation geometry and Poisson's ratio.

Für Kreisfundamente gilt:
 For circular foundations:

$$k_{\phi} = \frac{8 \cdot G \cdot r^3}{3 \cdot (1 - \nu)}$$

G = Schubmodul / shear modulus

r = Radius / radius

$$E_{\text{oed}} = k_{\phi} \cdot \frac{3}{4} \cdot \frac{1}{r^3} \cdot \frac{(1 + \nu) \cdot (1 - \nu)^2}{1 - \nu - 2 \cdot \nu^2}$$

ν = Querdehnzahl / Poisson's ratio

- Zulässige Schiefstellung / permissible tilting**
 Maximal zulässige Schiefstellung infolge Baugrundsetzung in 20 Jahren bezogen auf den Fundamentdurchmesser.
Maximum allowed tilting due to settlement of the foundation soil in 20 years relating to the foundation diameter.

$$\Delta s \leq 40 \text{ mm}$$

Document information:		
Author / date:	OL / 04.09.2006	Translator / date:
Department:	WRD-K	Revisor / date:
Approved / date:	MS / 04.09.2006	Reference:
Revision / date:	1.0 / 04.09.2006	WRD-04-FDB_E-82_BF_83_17_01_FloA_Rev1_1006.doc

28. NOV. 2006

Fundamentgeometrie
geometry of foundation

Außendurchmesser <i>outer diameter</i>	da	14,20 m
Innendurchmesser <i>inner diameter</i>	di	6,90 m
Sockeldurchmesser, außen <i>base diameter, outside</i>	dso _a	8,70 m
Sockeldurchmesser, innen <i>base diameter, inside</i>	dso _i	4,80 m
Fundamenthöhe <i>foundation height</i>	hges	2,85 m
Differenz Fundamentoberkante - GOK <i>difference top of foundation – top ground surface</i>	hgok	0,20 m
Betongüte und Volumen (Fundament) <i>Concrete and quantity (foundation)</i>	C 30/37	300 m ³
Betonstahl und Gewicht (Fundament) <i>Concrete steel and weight (foundation)</i>	BSt 500 S (A)	30,4

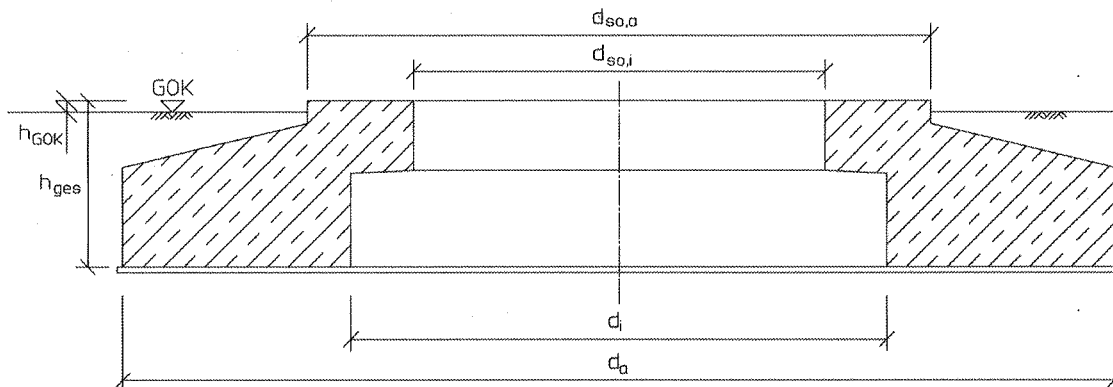

Bemerkungen / remarks

- Die angegebenen Lasten sind ausschließlich für geotechnische Nachweise zu verwenden.
The stated loads are only used for geotechnical calculations.
- Dieses Dokument wurde auf Anfrage bzw. für einen bestimmten Auftrag verschickt. Der Empfänger wurde nicht registriert! Der Empfänger wird bei Änderung nicht automatisch informiert!
This document has been sent on request on a certain order. The receiver has not been registered! The receiver will not be informed automatically in case of alterations!
- Weitergabe und Kopien an Dritte sind nur mit schriftlicher Zustimmung der ENERCON-Konstruktionsabteilung erlaubt.
Circulation of the data or copies are only enabled by written agreement from ENERCON design department.

Document information:		
Author / date:	OL / 04.09.2006	Translator / date:
Department:	WRD-K	Revisor / date:
Approved / date:	MS / 04.09.2006	Reference:
Revision / date:	1.0 / 04.09.2006	WRD-04-FDB_E-82_BF_83_17_01_FloA_Rev_01.dwg

REV. NORD
 28. NOV. 2006